

Signals and Systems

[Wikibooks.org](https://en.wikibooks.org/)

March 28, 2013

On the 28th of April 2012 the contents of the English as well as German Wikibooks and Wikipedia projects were licensed under Creative Commons Attribution-ShareAlike 3.0 Unported license. An URI to this license is given in the list of figures on page 113. If this document is a derived work from the contents of one of these projects and the content was still licensed by the project under this license at the time of derivation this document has to be licensed under the same, a similar or a compatible license, as stated in section 4b of the license. The list of contributors is included in chapter Contributors on page 109. The licenses GPL, LGPL and GFDL are included in chapter Licenses on page 117, since this book and/or parts of it may or may not be licensed under one or more of these licenses, and thus require inclusion of these licenses. The licenses of the figures are given in the list of figures on page 113. This PDF was generated by the L^AT_EX typesetting software. The L^AT_EX source code is included as an attachment (`source.7z.txt`) in this PDF file. To extract the source from the PDF file, we recommend the use of <http://www.pdfplabs.com/tools/pdftk-the-pdf-toolkit/> utility or clicking the paper clip attachment symbol on the lower left of your PDF Viewer, selecting **Save Attachment**. After extracting it from the PDF file you have to rename it to `source.7z`. To uncompress the resulting archive we recommend the use of <http://www.7-zip.org/>. The L^AT_EX source itself was generated by a program written by Dirk Hünninger, which is freely available under an open source license from http://de.wikibooks.org/wiki/Benutzer:Dirk_Huenniger/wb2pdf. This distribution also contains a configured version of the `pdflatex` compiler with all necessary packages and fonts needed to compile the L^AT_EX source included in this PDF file.

Contents

1	Signals and Systems/Print version	3
2	Introduction	5
2.1	What is this book for?	5
2.2	Who is this book for?	5
2.3	What will this book cover?	6
2.4	Where to go from here	6
3	MATLAB	7
3.1	What is MATLAB?	7
3.2	Obtaining MATLAB	7
3.3	MATLAB Clones	7
3.4	MATLAB Template	8
4	Signal and System Basics	9
4.1	Signals	9
4.2	Systems	9
4.3	Basic Functions	10
4.4	Unit Step Function	10
4.5	Impulse Function	13
4.6	Sinc Function	15
4.7	Rect Function	15
4.8	Square Wave	16
4.9	LTI Systems	17
4.10	Linear Time Invariant (LTI) Systems	20
4.11	Other Function Properties	20
4.12	Linear Operators	20
4.13	Impulse Response	21
4.14	Convolution	21
4.15	Correlation	24
4.16	White Noise	26
4.17	Colored Noise	26
4.18	White Noise and Autocorrelation	26
4.19	Noise Power	26
4.20	Thermal Noise	27
4.21	Periodic Signals	27
4.22	Terminology	27
4.23	Common Periodic Signals	31
4.24	Classifications	32

5	Frequency Representation	35
5.1	The Fourier Series	35
5.2	Rectangular Series	35
5.3	Polar Series	39
5.4	Exponential Series	40
5.5	Negative Frequency	41
5.6	Bandwidth	42
5.7	Examples	42
5.8	Further Reading	48
5.9	Periodic Inputs	48
5.10	Plotting Results	48
5.11	Power	49
5.12	Parsevals Theorem	49
5.13	Energy Spectrum	50
5.14	Power Spectral Density	50
5.15	Signal to Noise Ratio	50
5.16	Aperiodic Signals	51
5.17	Background	51
5.18	Fourier Transform	51
5.19	Inverse Fourier Transform	52
5.20	Duality	52
5.21	Power and Energy	53
5.22	Frequency Response	54
5.23	The Frequency Response Functions	54
5.24	Examples	55
5.25	Filters	59
6	Complex Frequency Representation	61
6.1	The Laplace Transform	61
6.2	Differential Equations	62
6.3	Example	62
7	Random Signals	65
7.1	Probability	65
7.2	Random Variable	65
7.3	Mean	65
7.4	Standard Deviation	66
7.5	Variance	66
7.6	Probability Function	66
7.7	Probability Density Function	66
7.8	Cumulative Distribution Function	66
7.9	Expected Value Operator	67
7.10	Moments	68
7.11	Central Moments	68
7.12	Moment Generating Functions	69
7.13	Time-Average Operator	69
7.14	Uniform Distribution	69
7.15	Gaussian Distribution	69

7.16	Poisson Distribution	70
7.17	Transformations	71
7.18	Further Reading	71
7.19	Frequency Analysis	71
7.20	Stationary vs Ergodic Functions	71
7.21	Power Spectral Density (PSD) of Gaussian White Noise	71
7.22	Wiener Khintchine Einstein Theorem	72
7.23	Bandwidth	72
7.24	Windowing	72
8	Introduction to Filters	73
8.1	Frequency Response	73
8.2	The Frequency Response Functions	73
8.3	Examples	74
8.4	Filters	78
8.5	Terminology	79
8.6	Lowpass	79
8.7	Highpass	80
8.8	Bandpass	80
8.9	Bandstop	80
8.10	Gain/Delay equalizers	80
8.11	Butterworth Filters	81
8.12	Chebyshev Filters	84
8.13	Elliptic Filters	87
8.14	Comparison	88
8.15	Bessel Filters	88
8.16	Filter Design	88
8.17	Normalized Lowpass Filter	89
8.18	Lowpass to Lowpass Transformation	89
8.19	Lowpass to Highpass	90
8.20	Lowpass to Bandpass	90
8.21	Lowpass to Bandstop	90
8.22	Brick-wall filters	91
8.23	Analog filters	91
8.24	The Complex Plane	92
8.25	Designing Filters	93
9	Introduction to Digital Signals	99
9.1	Sampled Systems	99
9.2	Sampling a signal	99
9.3	Z Transform	102
10	Appendices	105
10.1	Fourier Transform	105
10.2	Inverse Fourier Transform	105
10.3	Table of Fourier Transforms	105
10.4	Laplace Transform	106
10.5	Inverse Laplace Transform	106

10.6 Laplace Transform Properties	106
10.7 Table of Laplace Transforms	107
10.8 Useful Mathematical Identities	108
11 Contributors	109
List of Figures	113
12 Licenses	117
12.1 GNU GENERAL PUBLIC LICENSE	117
12.2 GNU Free Documentation License	118
12.3 GNU Lesser General Public License	119

1 Signals and Systems/Print version



This is the print version¹ of Signals and Systems²

You won't see this message or any elements not part of the book's content when you print or preview³ this page.

1 http://en.wikibooks.org/wiki/Help:Print_versions

2 http://en.wikibooks.org/wiki/Signals_and_Systems

3 http://en.wikibooks.org//en.wikibooks.org/w/index.php?title=Signals_and_Systems/Print_version&action=purge&printable=yes

2 Introduction

Signals and Systems¹

2.1 What is this book for?

The purpose of this book is to begin down the long and winding road of Electrical Engineering. Previous books on electric circuits have laid a general groundwork, but again: that is not what electrical engineers usually do with their time. Very complicated integrated circuits exist for most applications that can be picked up at a local circuit shop or hobby shop for pennies, and there is no sense creating new ones. As such, this book will most likely spend little or no time discussing actual circuit implementations of any of the structures discussed. Also, this book will not stumble through much of the complicated mathematics, instead opting to simply point out and tabulate the relevant results. What this book will do, however, is attempt to provide some insight into a field of study that is considered very foreign and arcane to most outside observers. This book will be a theoretical foundation that future books will build upon. This book will likely not discuss any specific implementations (no circuits, transceivers, filters, etc...), as these materials will be better handled in later books.

2.2 Who is this book for?

This book is designed to accompany a second year of study in electrical engineering at the college level. However, students who are not currently enrolled in an electrical engineering curriculum may also find some valuable and interesting information here. This book requires the reader to have a previous knowledge of differential calculus, and assumes familiarity with integral calculus as well. Barring previous knowledge, a concurrent course of study in integral calculus could accompany reading this book, with mixed results. Using Laplace Transforms, this book will avoid differential equations completely, and therefore no prior knowledge of that subject is needed. Having a prior knowledge of other subjects such as physics (wave dynamics, energy, forces, fields) will provide a deeper insight into this subject, although it is not required. Also, having a mathematical background in probability, statistics, or random variables will provide a deeper insight into the mechanics of noise signals, but that also is not required.

¹ http://en.wikibooks.org/wiki/Signals_and_Systems

2.3 What will this book cover?

This book is going to cover the theory of LTI systems and signals. This subject will form the fundamental basis for several other fields of study, including signal processing, Digital Signal Processing², Communication Systems³, and Control Systems⁴. This book will provide the basic theory of LTI systems and mathematical modeling of signals. We will also introduce the notion of a stochastic, or random, process. Random processes, such as noise or interference, are so common in the studies of these systems that it's impossible to discuss the practical use of filter systems without first discussing noise processes. Later sections will introduce some more advanced topics, such as digital signals and systems, and filters. This book will not discuss these topics at length, however, preferring to direct the reader to more comprehensive books on these subjects. This book will attempt, so far as is possible, to provide not only the materials but also discussions about the importance and relevance of those materials. Because the information in this book plays a fundamental role in preparing the reader for advanced discussions in other books.

2.4 Where to go from here

Once a basic knowledge of signals and systems has been learned, the reader can then take one of several paths of study.

- Readers interested in the use of electric signals for long-distance communications can read Communication Systems⁵ and Communication Networks⁶. This path will culminate in a study of Data Coding Theory⁷.
- Readers more interested in the analysis and processing of signals would likely be more interested in reading about Signal Processing⁸ and Digital Signal Processing⁹. These books will focus primarily on the "signals".
- Readers who are more interested in the use of LTI systems to exercise control over systems will be more interested in Control Systems¹⁰. This book will focus primarily on the "systems".

All three branches of study are going to share certain techniques and foundations, so many readers may find benefit in trying to follow the different paths simultaneously.

2 http://en.wikibooks.org/wiki/Digital_Signal_Processing
3 http://en.wikibooks.org/wiki/Communication_Systems
4 http://en.wikibooks.org/wiki/Control_Systems
5 http://en.wikibooks.org/wiki/Communication_Systems
6 http://en.wikibooks.org/wiki/Communication_Networks
7 http://en.wikibooks.org/wiki/Data_Coding_Theory
8 http://en.wikibooks.org/wiki/Signal_Processing
9 http://en.wikibooks.org/wiki/Digital_Signal_Processing
10 http://en.wikibooks.org/wiki/Control_Systems

3 MATLAB

Signals and Systems¹

3.1 What is MATLAB?

MATLAB - MATrix LABoratory is an industry standard tool in engineering applications. Electrical Engineers, working on topics related to this book will often use MATLAB to help with modeling. For more information on programming MATLAB, see MATLAB Programming².

3.2 Obtaining MATLAB

MATLAB itself is a relatively expensive piece of software. It is available for a fee from the Mathworks website.

3.3 MATLAB Clones

There are, however, free alternatives to MATLAB. These alternatives are frequently called "MATLAB Clones", although some of them do not mirror the syntax of MATLAB. The most famous example is **Octave**. Here are some resources if you are interested in obtaining Octave:

- SPM/MATLAB³
- Octave Programming Tutorial⁴
- MATLAB Programming/Differences between Octave and MATLAB⁵
- "Scilab / Scicoslab"⁶

1 http://en.wikibooks.org/wiki/Signals_and_Systems

2 http://en.wikibooks.org/wiki/MATLAB_Programming

3 <http://en.wikibooks.org/wiki/SPM/MATLAB>

4 http://en.wikibooks.org/wiki/Octave_Programming_Tutorial

5 http://en.wikibooks.org/wiki/MATLAB_Programming/Differences_between_Octave_and_MATLAB

6 <http://en.wikibooks.org/en.wikipedia.org/wiki/Scilab>

3.4 MATLAB Template

This book will make use of the `{{ MATLAB CMD7}}` template, that will create a note to the reader that MATLAB has a command to handle a particular task. In the individual chapters, this book will not discuss MATLAB outright, nor will it explain those commands. However, there will be some chapters at the end of the book that will demonstrate how to perform some of these calculations, and how to use some of these analysis tools in MATLAB.

7 http://en.wikibooks.org/wiki/Template:MATLAB_CMD

4 Signal and System Basics

4.1 Signals

What is a signal? Of course, we know that a signal can be a rather abstract notion, such as a flashing light on our car's front bumper (turn signal), or an umpire's gesture indicating that a pitch went over the plate during a baseball game (a strike signal). One of the definitions of signal in the Merriam-Webster dictionary is: "A detectable physical quantity or impulse (as a voltage, current, or magnetic field strength) by which messages or information can be transmitted." or "A signal is a function of independent variables that carry some information." "A signal is a physical quantity that varies with time, space or any other independent variable by which information can be conveyed" These are the types of signals which will be of interest in this book. We will focus on two broad classes of signals, *discrete-time* and *continuous-time*. We will consider discrete-time signals later. For now, we will focus our attention on continuous-time signals. Fortunately, continuous-time signals have a very convenient mathematical representation. We represent a continuous-time signal as a function $x(t)$ of the real variable t . Here, t represents **continuous time** and we can assign to t any unit of time we deem appropriate (seconds, hours, years, etc.). We do not have to make any particular assumptions about $x(t)$ such as "boundedness" (a signal is bounded if it has a finite value). Some of the signals we will work with are in fact, not bounded (i.e. they take on an infinite value). However most of the continuous-time signals we will deal with in the real world are bounded. Signal: a function representing some variable that contains some information about the behavior of a natural or artificial system. Signals are one part of the whole. Signals are meaningless without systems to interpret them, and systems are useless without signals to process. Signal: the energy (a traveling wave) that carries some information. Signal example: an electrical circuit signal may represent a time-varying voltage measured across a resistor. A signal can be represented as a function $x(t)$ of an independent variable t which usually represents time. If t is a continuous variable, $x(t)$ is a continuous-time signal, and if t is a discrete variable, defined only at discrete values of t , then $x(t)$ is a discrete-time signal. A discrete-time signal is often identified as a sequence of numbers, denoted by $x[n]$, where n is an integer. Signal: the representation of information.

4.2 Systems

A **System**, in the sense of this book, is any physical set of components that takes a signal, and produces a signal. In terms of engineering, the input is generally some electrical signal X , and the output is another electrical signal (response) Y . However, this may not always be the case. Consider a household thermostat, which takes input in the form of a knob or a switch, and in turn outputs electrical control signals for the furnace. A main purpose of this book is to try and lay some of the theoretical foundation for future dealings with electrical

signals. Systems will be discussed in a theoretical sense only.

Signals and Systems¹

4.3 Basic Functions

Often times, complex signals can be simplified as linear combinations of certain basic functions (a key concept in Fourier analysis). These basic functions, which are useful to the field of engineering, receive little or no coverage in traditional mathematics classes. These functions will be described here, and studied more in the following chapters.

4.4 Unit Step Function

The unit step function and the impulse function are considered to be fundamental functions in engineering, and it is strongly recommended that the reader becomes very familiar with both of these functions.

¹ http://en.wikibooks.org/wiki/Signals_and_Systems

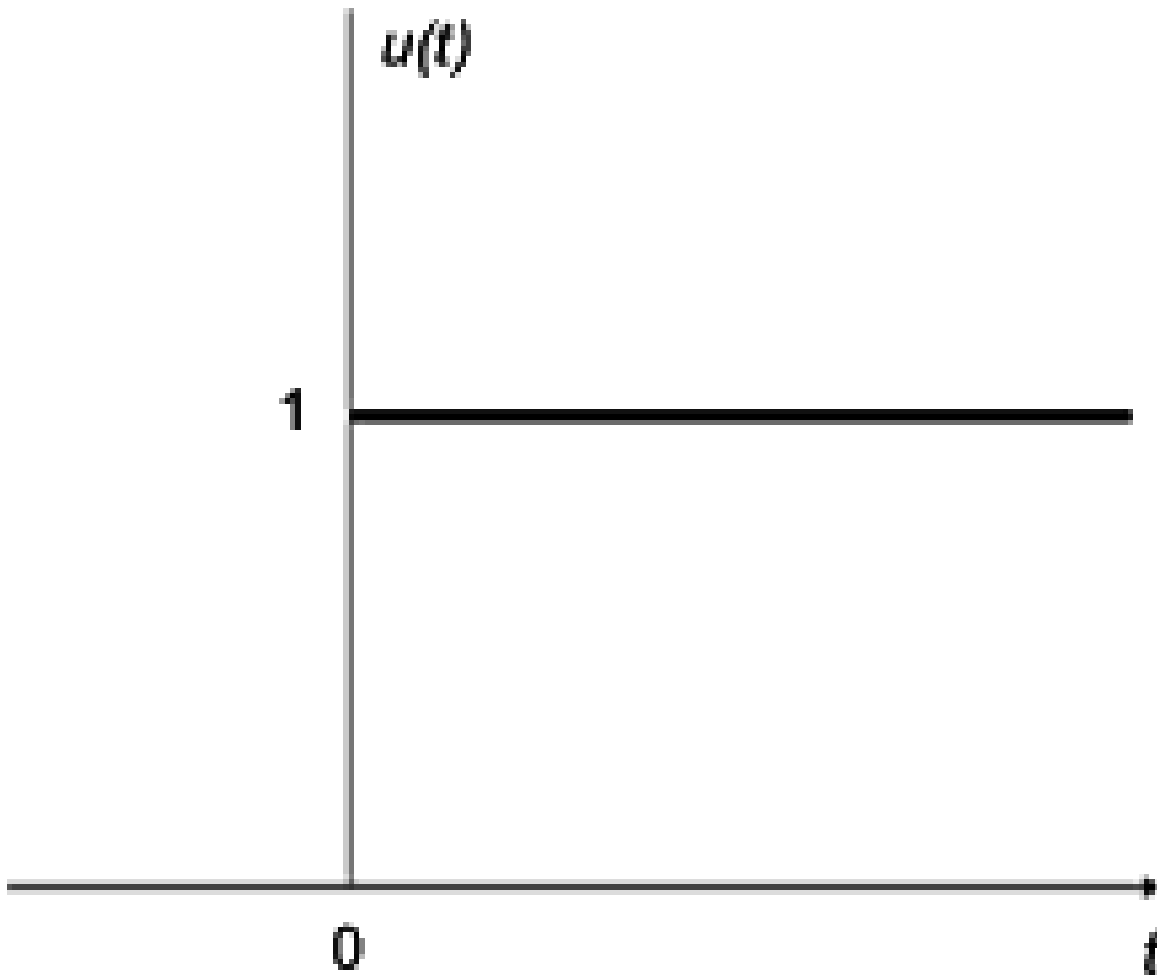

Figure 2 Unit Step Function

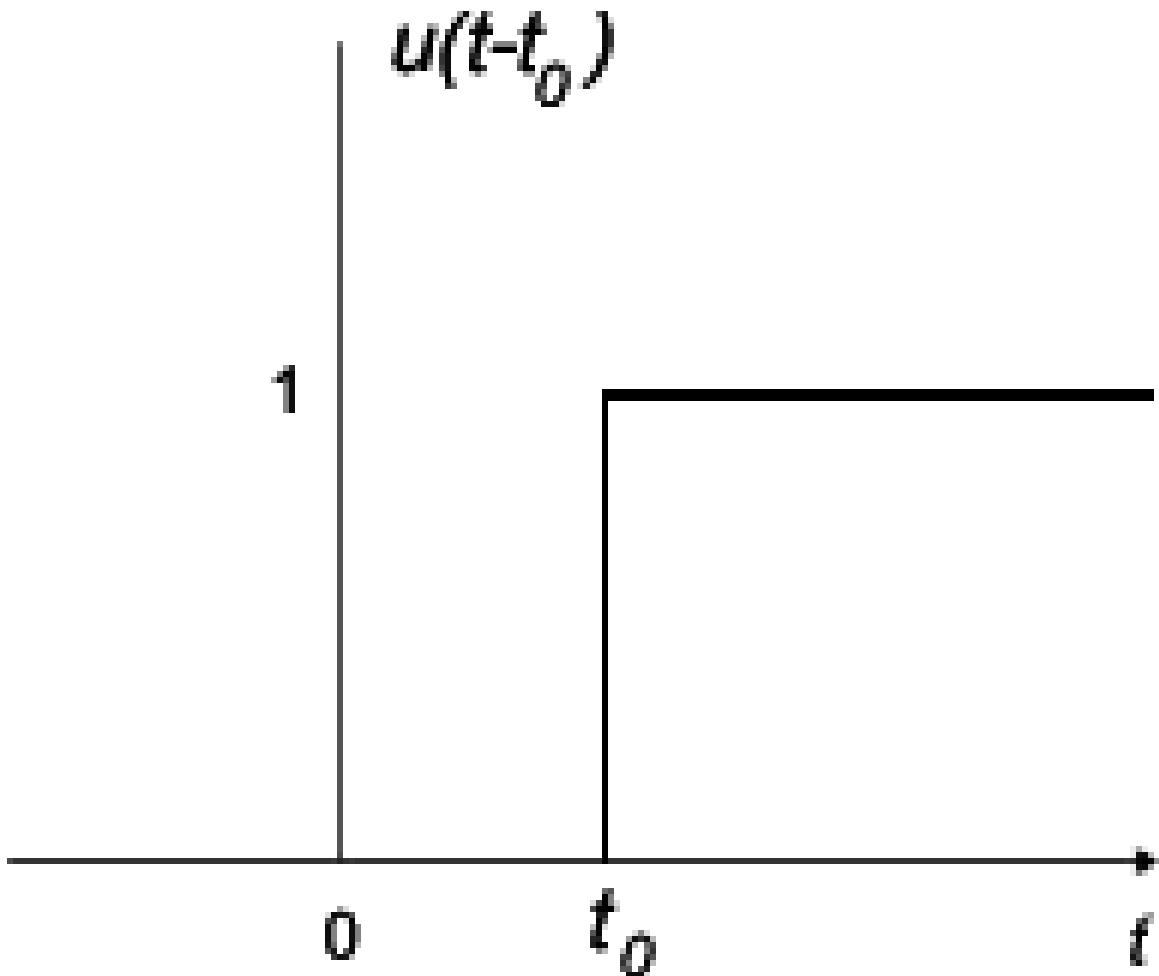

Figure 3 Shifted Unit Step function

The unit step function, also known as the Heaviside function², is defined as such:

$$u(t) = \begin{cases} 0, & \text{if } t < 0 \\ 1, & \text{if } t > 0 \\ \frac{1}{2}, & \text{if } t = 0 \end{cases}$$

Sometimes, $u(0)$ is given other values, usually either 0 or 1. For many applications, it is irrelevant what the value at zero is. $u(0)$ is generally written as undefined.

4.4.1 Derivative

The unit step function is level in all places except for a discontinuity at $t = 0$. For this reason, the derivative of the unit step function is 0 at all points t , except where $t = 0$. Where $t = 0$, the derivative of the unit step function is infinite. The derivative of a unit step function is called an **impulse function**. The impulse function will be described in more detail next.

² http://en.wikibooks.org/en.wikipedia.org/wiki/Heaviside_step_function

4.4.2 Integral

The integral of a unit step function is computed as such:

$$\int_{-\infty}^t u(s)ds = \begin{cases} 0, & \text{if } t < 0 \\ \int_0^t ds = t, & \text{if } t \geq 0 \end{cases} = tu(t)$$

In other words, the integral of a unit step is a "ramp" function. This function is 0 for all values that are less than zero, and becomes a straight line at zero with a slope of +1.

4.4.3 Time Inversion

if we want to reverse the unit step function, we can flip it around the y axis as such: $u(-t)$. With a little bit of manipulation, we can come to an important result:

$$u(-t) = 1 - u(t)$$

4.4.4 Other Properties

Here we will list some other properties of the unit step function:

- $u(\infty) = 1$
- $u(-\infty) = 0$
- $u(t) + u(-t) = 1$

These are all important results, and the reader should be familiar with them.

4.5 Impulse Function

An impulse function is a special function that is often used by engineers to model certain events. An impulse function is not realizable, in that by definition the output of an impulse function is infinity at certain values. An impulse function is also known as a "delta function", although there are different types of delta functions that each have slightly different properties. Specifically, this *unit-impulse function* is known as the Dirac delta function. The term "Impulse Function" is unambiguous, because there is only one definition of the term "Impulse". Let's start by drawing out a rectangle function, $D(t)$, as such:

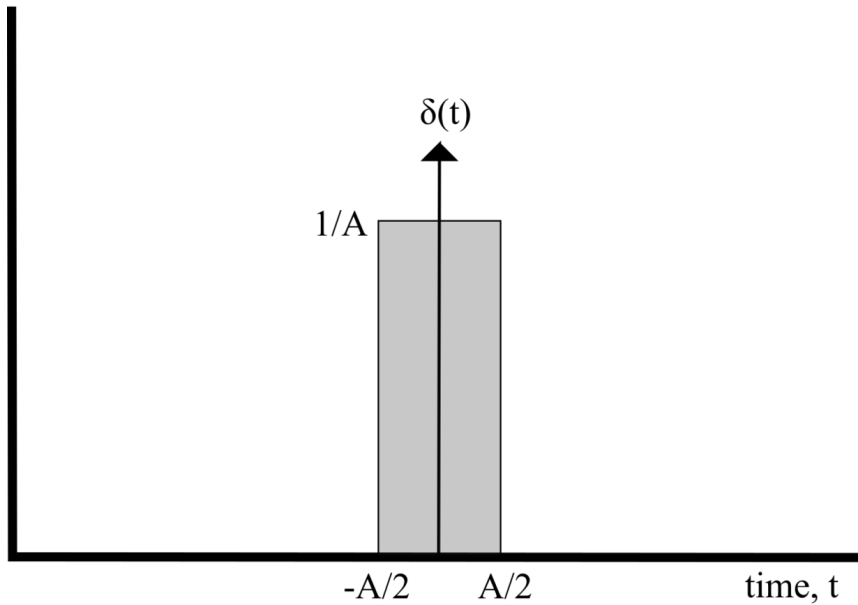

Figure 4

We can define this rectangle in terms of the unit step function:

$$D(t) = \frac{1}{A}[u(t + A/2) - u(t - A/2)]$$

Now, we want to analyze this rectangle, as A becomes infinitesimally small. We can define this new function, the **delta function**, in terms of this rectangle:

$$\delta(t) = \lim_{A \rightarrow 0} \frac{1}{A}[u(t + A/2) - u(t - A/2)]$$

We can similarly define the delta function piecewise, as such:

1. $\delta(t) = 0$ for $t \neq 0$.
2. $\delta(t) > 0$ for $t = 0$.
3. $\int_{-\infty}^{\infty} \delta(t) dt = 1$.

Although, this definition is less rigorous than the previous definition.

4.5.1 Integration

From its definition it follows that the integral of the impulse function is just the step function:

$$\int \delta(t) dt = u(t)$$

Thus, defining the derivative of the unit step function as the impulse function is justified.

4.5.2 Shifting Property

Furthermore, for an integrable function f :

$$\int_{-\infty}^{\infty} \delta(t - A) f(t) dt = f(A)$$

This is known as the **shifting property** (also known as the **sifting property** or the **sampling property**) of the delta function; it effectively samples the value of the function f , at location A . The delta function has many uses in engineering, and one of the most important uses is to sample a continuous function into discrete values. Using this property, we can extract a single value from a continuous function by multiplying with an impulse, and then integrating.

4.5.3 Types of Delta

There are a number of different functions that are all called "delta functions". These functions generally all look like an impulse, but there are some differences. Generally, this book uses the term "delta function" to refer to the **Dirac Delta Function**.

- w:Dirac delta function³
- w:Kronecker delta⁴

4.6 Sinc Function

There is a particular form that appears so frequently in communications engineering, that we give it its own name. This function is called the "Sinc function" and is discussed below: The Sinc function is defined in the following manner:

$$\text{sinc}(x) = \frac{\sin(\pi x)}{\pi x} \text{ if } x \neq 0$$

and

$$\text{sinc}(0) = 1$$

The value of $\text{sinc}(x)$ is defined as 1 at $x = 0$, since

$$\lim_{x \rightarrow 0} \text{sinc}(x) = 1.$$

This fact can be proven by noting that for x near 0,

$$1 > \frac{\sin(x)}{x} > \cos(x).$$

Then, since $\cos(0) = 1$, we can apply the *Squeeze Theorem*⁵ to show that the sinc function approaches one as x goes to zero. Thus, defining $\text{sinc}(0)$ to be 1 makes the sinc function continuous. Also, the Sinc function approaches zero as x goes towards infinity, with the envelope of $\text{sinc}(x)$ tapering off as $1/x$.

4.7 Rect Function

The Rect Function is a function which produces a rectangular-shaped pulse with a width of 1 centered at $t = 0$. The Rect function pulse also has a height of 1. The Sinc function and

³ http://en.wikibooks.org/en.wikipedia.org/wiki/Dirac_delta_function

⁴ http://en.wikibooks.org/en.wikipedia.org/wiki/Kronecker_delta

⁵ http://en.wikibooks.org/wiki/Calculus/Limits/An_Introduction_to_Limits#The_Squeeze_Theorem

the rectangular function form a Fourier transform pair. A Rect function can be written in the form:

$$\text{rect}\left(\frac{t-X}{Y}\right)$$

where the pulse is centered at X and has width Y . We can define the impulse function above in terms of the rectangle function by centering the pulse at zero ($X = 0$), setting it's height to $1/A$ and setting the pulse width to A , which approaches zero:

$$\delta(t) = \lim_{A \rightarrow 0} \frac{1}{A} \text{rect}\left(\frac{t-0}{A}\right)$$

We can also construct a Rect function out of a pair of unit step functions:

$$\text{rect}\left(\frac{t-X}{Y}\right) = u(t-X+Y/2) - u(t-X-Y/2)$$

Here, both unit step functions are set a distance of $Y/2$ away from the center point of $(t - X)$.

4.8 Square Wave

A square wave is a series of rectangular pulses. Here are some examples of square waves:

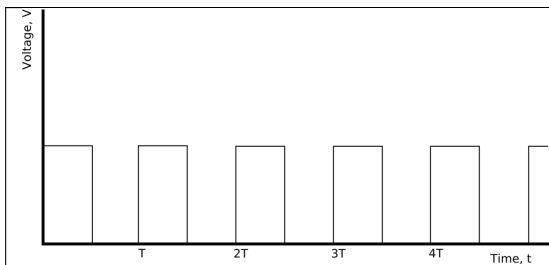

Figure 5

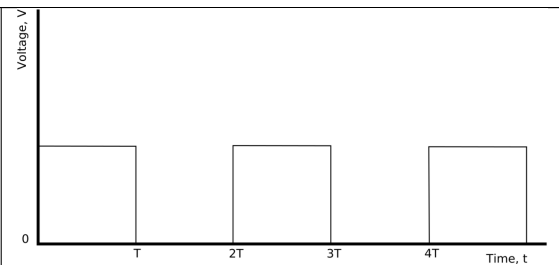

Figure 6

These two square waves have the same amplitude, but the second has a lower frequency. We can see that the period of the second is approximately twice as large as the first, and therefore that the frequency of the second is about half the frequency of the first.

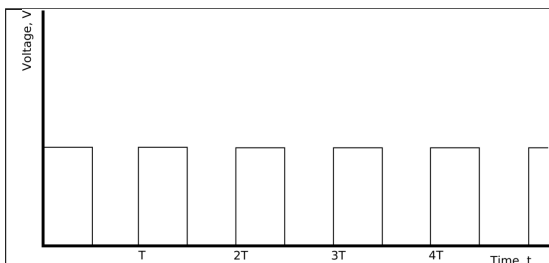

Figure 7

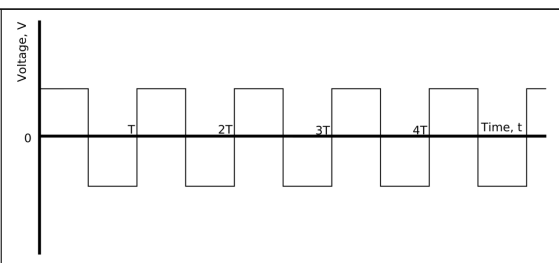

Figure 8

<p>These two square waves have the same frequency and the same peak-to-peak amplitude, but the second wave has no DC offset. Notice how the second wave is centered on the x axis, while the first wave is completely above the x axis.</p>	
---	--

Signals and Systems⁶

There are many tools available to analyze a system in the time domain, although many of these tools are very complicated and involved. Nonetheless, these tools are invaluable for use in the study of linear signals and systems, so they will be covered here.

This book contains mathematical formulae that look better **rendered as PNG**⁷.

4.9 LTI Systems

This page will contain the definition of a LTI system and this will be used to motivate the definition of convolution as the output of a LTI system in the next section. To begin with a system has to be defined and the LTI properties have to be listed. Then, for a given input it can be shown (in this section or the following) that the output of a LTI system is a convolution of the input and the system's impulse response, thus motivating the definition of convolution. Consider a system for which an input of $x_i(t)$ results in an output of $y_i(t)$ respectively for $i = 1, 2$.

4.9.1 Linearity

There are 3 requirements for *linearity*. A function must satisfy all 3 to be called "linear".

1. **Additivity:** An input of $x_3(t) = x_1(t) + x_2(t)$ results in an output of $y_3(t) = y_1(t) + y_2(t)$.
2. **Homogeneity:** An input of ax_1 results in an output of ay_1
3. If $x(t) = 0$, $y(t) = 0$.

"Linear" in this sense is not the same word as is used in conventional algebra or geometry. Specifically, linearity in signals applications has nothing to do with straight lines. Here is a small example:

$$y(t) = x(t) + 5$$

⁶ http://en.wikibooks.org/wiki/Signals_and_Systems

⁷ http://en.wikibooks.org/wiki/Wikibooks:Render_as_PNG

This function is not linear, because when $x(t) = 0$, $y(t) = 5$ (fails requirement 3). This may surprise people, because this equation is the equation for a straight line! Being linear is also known in the literature as "satisfying the principle of superposition". **Superposition** is a fancy term for saying that the system is additive and homogeneous. The terms linearity and superposition can be used interchangeably, but in this book we will prefer to use the term linearity exclusively. We can combine the three requirements into a single equation: In a linear system, an input of $a_1x_1(t) + a_2x_2(t)$ results in an output of $a_1y_1(t) + a_2y_2(t)$.

4.9.2 Additivity

A system is said to be additive if a sum of inputs results in a sum of outputs. To test for additivity, we need to create two arbitrary inputs, $x_1(t)$ and $x_2(t)$. We then use these inputs to produce two respective outputs:

$$y_1(t) = f(x_1(t))$$

$$y_2(t) = f(x_2(t))$$

Now, we need to take a sum of inputs, and prove that the system output is a sum of the previous outputs:

$$y_1(t) + y_2(t) = f(x_1(t) + x_2(t))$$

If this final relationship is not satisfied for *all possible inputs*, then the system is not additive.

4.9.3 Homogeneity

Similar to additivity, a system is homogeneous if a scaled input (multiplied by a constant) results in a scaled output. If we have two inputs to a system:

$$y_1(t) = f(x_1(t))$$

$$y_2(t) = f(x_2(t))$$

Where

$$x_1(t) = cx_2(t)$$

Where c is an arbitrary constant. If this is the case then the system is homogeneous if

$$y_1(t) = cy_2(t)$$

for any arbitrary c .

4.9.4 Time Invariance

If the input signal $x(t)$ produces an output $y(t)$ then any time shifted input, $x(t + \delta)$, results in a time-shifted output $y(t + \delta)$. This property can be satisfied if the transfer function of the system is not a function of time except expressed by the input and output.

4.9.5 Example: Simple Time Invariance

To demonstrate how to determine if a system is time-invariant then consider the two systems:

- System A: $y(t) = tx(t)$
- System B: $b(t) = 10x(t)$

Since system A explicitly depends on t outside of $x(t)$ and $y(t)$ then it is **time-variant**. System B, however, does not depend explicitly on t so it is time-invariant.

4.9.6 Example: Formal Proof

A more formal proof of why systems A & B from above are respectively time varying and time-invariant is now presented. To perform this proof, the second definition of time invariance will be used.

System A

Start with a delay of the input $x_d(t) = x(t + \delta)$

$$y(t) = tx_d(t)$$

$$y_1(t) = tx_d(t) = tx(t + \delta)$$

Now delay the output by δ

$$y(t) = tx(t)$$

$$y_2(t) = y(t + \delta) = (t + \delta)x(t + \delta)$$

Clearly $y_1(t) \neq y_2(t)$, therefore the system is not time-invariant.

System B

Start with a delay of the input $x_d(t) = x(t + \delta)$

$$y(t) = 10x_d(t)$$

$$y_1(t) = 10x_d(t) = 10x(t + \delta)$$

Now delay the output by δ

$$y(t) = 10x(t)$$

$$y_2(t) = y(t + \delta) = 10x(t + \delta)$$

Clearly $y_1(t) = y_2(t)$, therefore the system is time-invariant.

4.10 Linear Time Invariant (LTI) Systems

The system is linear time-invariant (LTI) if it satisfies both the property of linearity and time-invariance. This book will study LTI systems almost exclusively, because they are the easiest systems to work with, and they are ideal to analyze and design.

4.11 Other Function Properties

Besides being linear, or time-invariant, there are a number of other properties that we can identify in a function:

4.11.1 Memory

A system is said to have memory if the output from the system is dependent on past inputs (or future inputs) to the system. A system is called **memoryless** if the output is only dependent on the current input. Memoryless systems are easier to work with, but systems with memory are more common in digital signal processing applications. A memory system is also called a dynamic system whereas a memoryless system is called a static system.

4.11.2 Causality

Causality is a property that is very similar to memory. A system is called **causal** if it is only dependent on past or current inputs. A system is called **non-causal** if the output of the system is dependent on future inputs. Most of the practical systems are casual.

4.11.3 Stability

Stability is a very important concept in systems, but it is also one of the hardest function properties to prove. There are several different criteria for system stability, but the most common requirement is that the system must produce a finite output when subjected to a finite input. For instance, if we apply 5 volts to the input terminals of a given circuit, we would like it if the circuit output didn't approach infinity, and the circuit itself didn't melt or explode. This type of stability is often known as "Bounded Input, Bounded Output" stability, or BIBO. Studying BIBO stability is a relatively complicated course of study, and later books on the Electrical Engineering bookshelf will attempt to cover the topic.

4.12 Linear Operators

Mathematical operators that satisfy the property of linearity are known as **linear operators**. Here are some common linear operators:

1. Derivative
2. Integral

3. Fourier Transform

4.12.1 Example: Linear Functions

Determine if the following two functions are linear or not:

1. $y(t) = \int_{-\infty}^{\infty} x(t) dt$
2. $y(t) = \frac{d}{dt}x(t)$

4.13 Impulse Response

4.13.1 Zero-Input Response

$$x(t) = u(t)$$

$$h(t) = e^{-x}u(t)$$

4.13.2 Zero-State Response

4.13.3 Second-Order Solution

- Example⁸. Finding the total response of a driven RLC circuit.

4.14 Convolution

This operation can be performed using this MATLAB⁹ command:

conv

Convolution (folding together) is a complicated operation involving integrating, multiplying, adding, and time-shifting two signals together. Convolution is a key component to the rest of the material in this book. The convolution $a * b$ of two functions a and b is defined as the function:

$$(a * b)(t) = \int_{-\infty}^{\infty} a(\tau)b(t - \tau)d\tau$$

The greek letter τ (tau) is used as the integration variable, because the letter t is already in use. τ is used as a "dummy variable" because we use it merely to calculate the integral. In the convolution integral, all references to t are replaced with τ , except for the $-t$ in the argument to the function b . Function b is *time inverted* by changing τ to $-\tau$. Graphically, this process moves everything from the right-side of the y axis to the left side and vice-versa. Time inversion turns the function into a mirror image of itself. Next, function b is *time-shifted* by

⁸ http://en.wikibooks.org/w/index.php?title=Signals_and_Systems/Print_version/System_Response&action=edit&redlink=1
⁹ http://en.wikibooks.org/wiki/MATLAB_Programming

the variable t . Remember, once we replace everything with τ , we are now computing in the *tau domain*, and not in the time domain like we were previously. Because of this, t can be used as a shift parameter. We multiply the two functions together, time shifting along the way, and we take the area under the resulting curve at each point. Two functions overlap in increasing amounts until some "watershed" after which the two functions overlap less and less. Where the two functions overlap in the t domain, there is a value for the convolution. If one (or both) of the functions do not exist over any given range, the value of the convolution operation at that range will be zero. After the integration, the definite integral plugs the variable t back in for remaining references of the variable τ , and we have a function of t again. It is important to remember that the resulting function will be a combination of the two input functions, and will share some properties of both.

4.14.1 Properties of Convolution

The convolution function satisfies certain conditions:

Commutativity

$$f * g = g * f$$

Associativity

$$f * (g * h) = (f * g) * h$$

Distributivity

$$f * (g + h) = (f * g) + (f * h)$$

Associativity With Scalar Multiplication

$$a(f * g) = (af) * g = f * (ag)$$

for any real (or complex) number a .

Differentiation Rule

$$(f * g)' = f' * g = f * g'$$

4.14.2 Example 1

Find the convolution, $z(t)$, of the following two signals, $x(t)$ and $y(t)$, by using (a) the integral representation of the convolution equation and (b) multiplication in the Laplace domain.

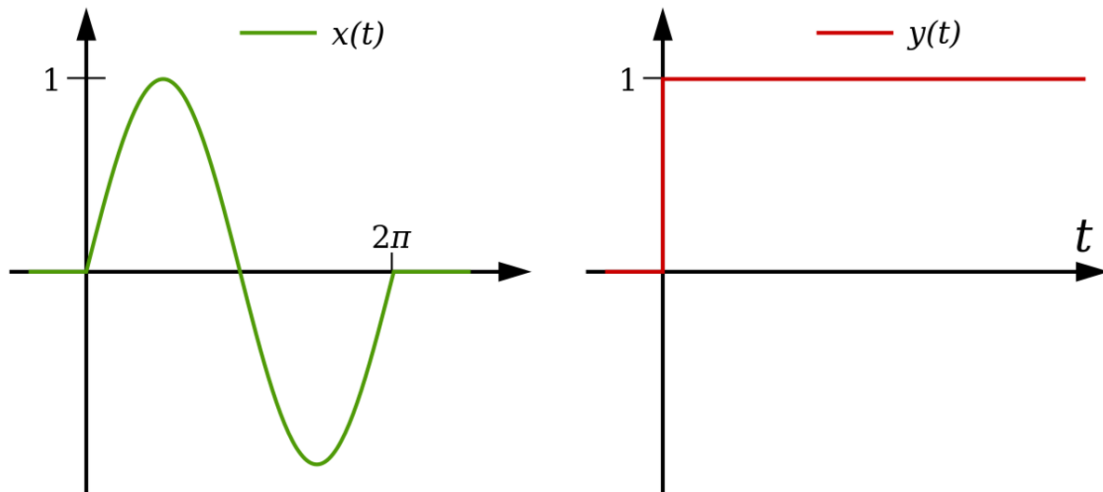

Figure 9

The signal $y(t)$ is simply the Heaviside step¹⁰, $u(t)$. The signal $x(t)$ is given by the following infinite sinusoid, $x_0(t)$, and windowing function, $x_w(t)$:

$$x_0(t) = \sin(t)$$

$$x_w(t) = u(t) - u(t - 2\pi)$$

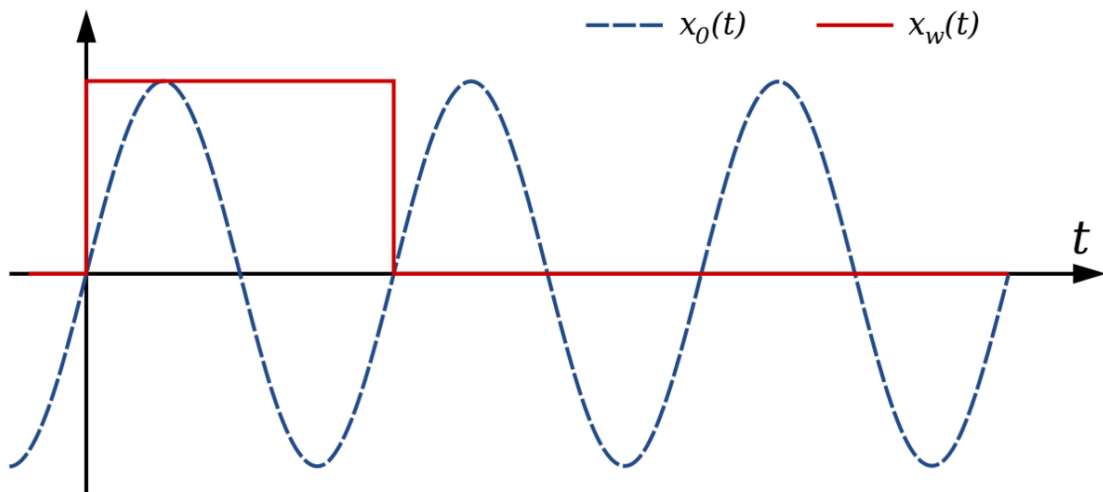

Figure 10

¹⁰ http://en.wikibooks.org/en.wikipedia.org/wiki/Heaviside_step

Thus, the convolution we wish to perform is therefore:

$$z(t) = x(t) * y(t)$$

$$z(t) = \sin(t) [u(t) - u(t - 2\pi)] * u(t)$$

$$z(t) = [\sin(t)u(t) - \sin(t)u(t - 2\pi)] * u(t)$$

From the distributive law:

$$z(t) = \sin(t)u(t) * u(t) - \sin(t)u(t - 2\pi) * u(t)$$

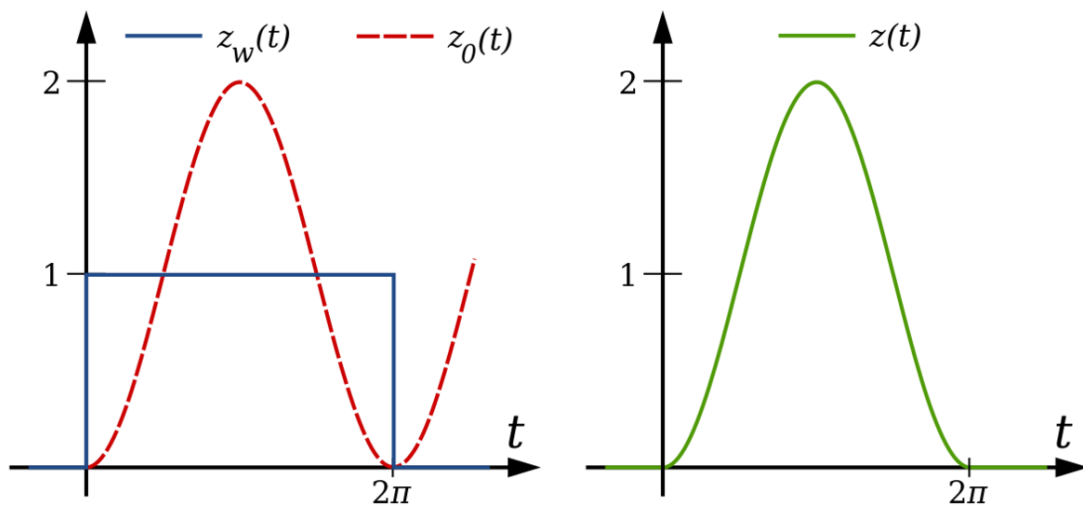

Figure 11

4.15 Correlation

This operation can be performed using this MATLAB¹¹ command:

xcorr

¹¹ http://en.wikibooks.org/wiki/MATLAB_Programming

Akin to Convolution is a technique called "Correlation" that combines two functions in the time domain into a single resultant function in the time domain. Correlation is not as important to our study as convolution is, but it has a number of properties that will be useful nonetheless. The correlation of two functions, $g(t)$ and $h(t)$ is defined as such:

$$R_{gh}(t) = \int_{-\infty}^{\infty} g(\tau)h(t+\tau)d\tau$$

Where the capital R is the **Correlation Operator**, and the subscripts to R are the arguments to the correlation operation. We notice immediately that correlation is similar to convolution, except that we don't time-invert the second argument before we shift and integrate. Because of this, we can define correlation in terms of convolution, as such:

$$R_{gh}(t) = g(t) * h(-t)$$

4.15.1 Uses of Correlation

Correlation is used in many places because it demonstrates one important fact: Correlation determines how much similarity there is between the two argument functions. The more the area under the correlation curve, the more is the similarity between the two signals.

4.15.2 Autocorrelation

The term "autocorrelation" is the name of the operation when a function is correlated with itself. The autocorrelation is denoted when both of the subscripts to the Correlation operator are the same:

$$R_{xx}(t) = x(t) * x(-t)$$

While it might seem ridiculous to correlate a function with itself, there are a number of uses for autocorrelation that will be discussed later. Autocorrelation satisfies several important properties:

1. The maximum value of the autocorrelation always occurs at $t = 0$. The function always decreases (or stays constant) as t approaches infinity.
2. Autocorrelation is symmetric about the x axis.

4.15.3 Crosscorrelation

Cross correlation is every instance of correlation that is not considered "autocorrelation". In general, crosscorrelation occurs when the function arguments to the correlation are not equal. Crosscorrelation is used to find the similarity between two signals.

4.15.4 Example: RADAR

RADAR is a system that uses pulses of electromagnetic waves to determine the position of a distant object. RADAR operates by sending out a signal, and then listening for echos. If there is an object in range, the signal will bounce off that object and return to the RADAR station. The RADAR will then take the cross correlation of two signals, the sent signal and

the received signal. A spike in the cross correlation signal indicates that an object is present, and the location of the spike indicates how much time has passed (and therefore how far away the object is).

Signals and Systems¹²

Noise is an unfortunate phenomenon that is the greatest single enemy of an electrical engineer. Without noise, digital communication rates would increase almost to infinity.

4.16 White Noise

White Noise, or Gaussian Noise is called white because it affects all the frequency components of a signal equally. We don't talk about Frequency Domain analysis till a later chapter, but it is important to know this terminology now.

4.17 Colored Noise

Colored noise is different from white noise in that it affects different frequency components differently. For example, Pink Noise is random noise with an equal amount of power in each frequency octave band.

4.18 White Noise and Autocorrelation

White Noise is completely random, so it would make intuitive sense to think that White Noise has zero autocorrelation. As the noise signal is time shifted, there is no correlation between the values. In fact, there is no correlation at all until the point where $t = 0$, and the noise signal perfectly overlaps itself. At this point, the correlation spikes upward. In other words, the autocorrelation of noise is an Impulse Function¹³ centered at the point $t = 0$.

$$\mathcal{C}[n(t), n(t)] = \delta(t)$$

Where $n(t)$ is the noise signal.

4.19 Noise Power

Noise signals have a certain amount of energy associated with them. The more energy and transmitted power that a noise signal has, the more interference the noise can cause in a transmitted data signal. We will talk more about the power associated with noise in later chapters.

¹² http://en.wikibooks.org/wiki/Signals_and_Systems

¹³ http://en.wikibooks.org/w/index.php?title=Signals_and_Systems/Engineering_Functions/Impulse_Function&action=edit&redlink=1

4.20 Thermal Noise

Thermal noise is a fact of life for electronics. As components heat up, the resistance of resistors change, and even the capacitance and inductance of energy storage elements can be affected. This change amounts to noise in the circuit output. In this chapter, we will study the effects of thermal noise. The *thermal noise* or *white noise* or *Johnson noise* is the random noise which is generated in a resistor or the resistive component of a complex impedance due to rapid and random motion of the molecules, atoms and electrons. According to the kinetic theory of thermodynamics, the temperature of a particle denotes its internal kinetic energy. This means that the temperature of a body expresses the rms value of the velocity of motion of the particles in a body. As per this kinetic theory, the kinetic energy of these particles becomes approximately zero (i.e. zero velocity) at absolute zero. Therefore, the noise power produced in a resistor is proportional to its absolute temperature. Also the noise power is proportional to the bandwidth over which the noise is measured. Therefore the expression for maximum noise power output of a resistor may be given as:

$$P_n = k \cdot T \cdot B$$

where

k is Boltzmann's constant

T is the absolute temperature, in Kelvin degrees

B is the bandwidth of interest, in Hertz.

Signals and Systems¹⁴

4.21 Periodic Signals

A signal is a periodic signal if it completes a pattern within a measurable time frame, called a period and repeats that pattern over identical subsequent periods. The completion of a full pattern is called a cycle. A period is defined as the amount of time (expressed in seconds) required to complete one full cycle. The duration of a period represented by T, may be different for each signal but it is constant for any given periodic signal.

4.22 Terminology

We will discuss here some of the common terminology that pertains to a periodic function. Let $g(t)$ be a periodic function satisfying $g(t + T) = g(t)$ for all t .

4.22.1 Period

The **period** is the smallest value of T satisfying $g(t + T) = g(t)$ for all t . The period is defined so because if $g(t + T) = g(t)$ for all t , it can be verified that $g(t + T') = g(t)$ for all

¹⁴ http://en.wikibooks.org/wiki/Signals_and_Systems

t where $T' = 2T, 3T, 4T, \dots$. In essence, it's the smallest amount of time it takes for the function to repeat itself. If the period of a function is finite, the function is called "periodic". Functions that never repeat themselves have an infinite period, and are known as "aperiodic functions". The period of a periodic waveform will be denoted with a capital T . The period is measured in seconds.

4.22.2 Frequency

The frequency of a periodic function is the number of complete cycles that can occur per second. Frequency is denoted with a lower-case f . It is defined in terms of the period, as follows:

$$f = \frac{1}{T}$$

Frequency has units of *hertz* or cycle per second.

4.22.3 Radial Frequency

The radial frequency is the frequency in terms of radians. it is defined as follows:

$$\omega = 2\pi f$$

4.22.4 Amplitude

The amplitude of a given wave is the value of the wave at that point. Amplitude is also known as the "Magnitude" of the wave at that particular point. There is no particular variable that is used with amplitude, although capital A, capital M and capital R are common. The amplitude can be measured in different units, depending on the signal we are studying. In an electric signal the amplitude will typically be measured in volts. In a building or other such structure, the amplitude of a vibration could be measured in meters.

4.22.5 Continuous Signal

A continuous signal is a "smooth" signal, where the signal is defined over a certain range. For example, a sine function is a continuous sample, as is an exponential function or a constant function. A portion of a sine signal over a range of time 0 to 6 seconds is also continuous. Examples of functions that are not continuous would be any discrete signal, where the value of the signal is only defined at certain intervals.

4.22.6 DC Offset

A *DC Offset* is an amount by which the average value of the periodic function is not centered around the x -axis. A periodic signal has a DC offset component if it is not centered about the x -axis. In general, the DC value is the amount that must be subtracted from the signal to center it on the x -axis. by definition:

$$A_0 = (1/T) * \int_{-T/2}^{T/2} f(x) dx$$

With A_0 being the DC offset. If $A_0 = 0$, the function is centered and has no offset.

4.22.7 Half-wave Symmetry

To determine if a signal with period $2L$ has half-wave symmetry, we need to examine a single period of the signal. If, when shifted by half the period, the signal is found to be the negative of the original signal, then the signal has half-wave symmetry. That is, the following property is satisfied:

$$f(t-L) = -f(t)$$

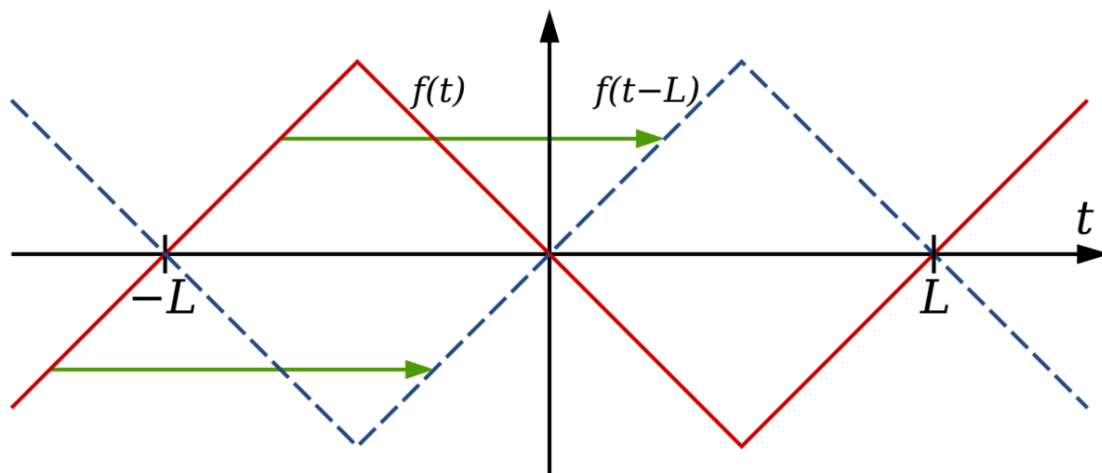

Figure 12

Half-wave symmetry implies that the second half of the wave is exactly opposite to the first half. A function with half-wave symmetry does not have to be even or odd, as this property requires only that the shifted signal is opposite, and this can occur for any temporal offset. However, it does require that the DC offset is zero, as one half must exactly cancel out the other. If the whole signal has a DC offset, this cannot occur, as when one half is added to the other, the offsets will add, not cancel. Note that if a signal is symmetric about the the half-period point, it is *not* necessarily half-wave symmetric. An example of this is the function t^3 , periodic on $[-1,1)$, which has no DC offset and odd symmetry about $t=0$. However, when shifted by 1, the signal is *not* opposite to the original signal.

4.22.8 Quarter-Wave Symmetry

If a signal has the following properties, it is said to quarter-wave symmetric:

- It is half-wave symmetric.

- It has symmetry (odd or even) about the quarter-period point (i.e. at a distance of $L/2$ from an end or the centre).

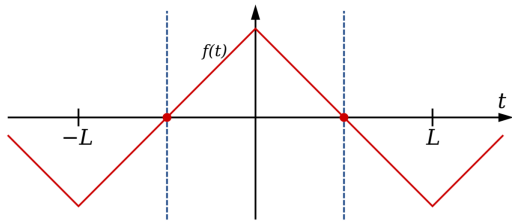

Figure 13
Even Signal with Quarter-Wave Symmetry

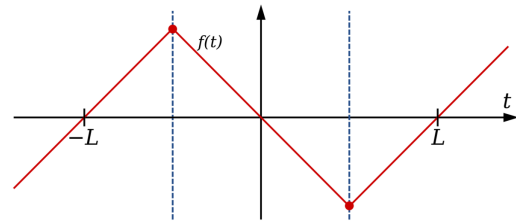

Figure 14
Odd Signal with Quarter-Wave Symmetry

Any quarter-wave symmetric signal can be made even or odd by shifting it up or down the time axis. A signal does not have to be odd or even to be quarter-wave symmetric, but in order to find the quarter-period point, the signal will need to be shifted up or down to make it so. Below is an example of a quarter-wave symmetric signal (red) that does not show this property without first being shifted along the time axis (green, dashed):

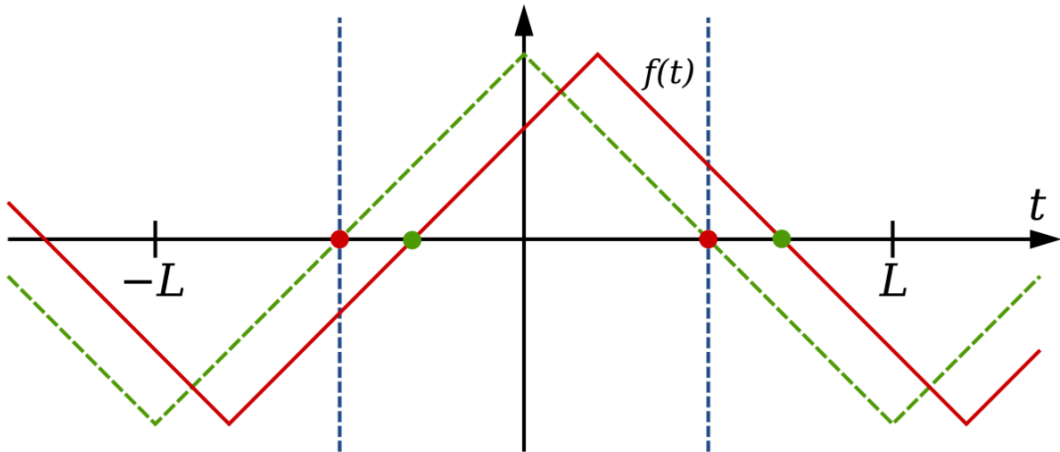

Figure 15
Asymmetric Signal with Quarter-Wave Symmetry

An equivalent operation is shifting the interval the function is defined in. This may be easier to reconcile with the formulae for Fourier series. In this case, the function would be redefined to be periodic on $(-L+\Delta, L+\Delta)$, where Δ is the shift distance.

4.22.9 Discontinuities

Discontinuities are an artifact of some signals that make them difficult to manipulate for a variety of reasons. In a graphical sense, a periodic signal has discontinuities whenever there is a vertical line connecting two adjacent values of the signal. In a more mathematical sense, a periodic signal has discontinuities anywhere that the function has an undefined

(or an infinite) derivative. These are also places where the function does not have a limit, because the values of the limit from both directions are not equal.

4.23 Common Periodic Signals

There are some common periodic signals that are given names of their own. We will list those signals here, and discuss them.

4.23.1 Sinusoid

The quintessential periodic waveform. These can be either Sine functions, or Cosine Functions.

4.23.2 Square Wave

The square wave is exactly what it sounds like: a series of rectangular pulses spaced equidistant from each other, each with the same amplitude.

4.23.3 Triangle Wave

The triangle wave is also exactly what it sounds like: a series of triangles. These triangles may touch each other, or there may be some space in between each wavelength.

4.23.4 Example: Sinusoid, Square, and Triangle Waves

Here is an image that shows some of the common periodic waveforms, a triangle wave, a square wave, a sawtooth wave, and a sinusoid.

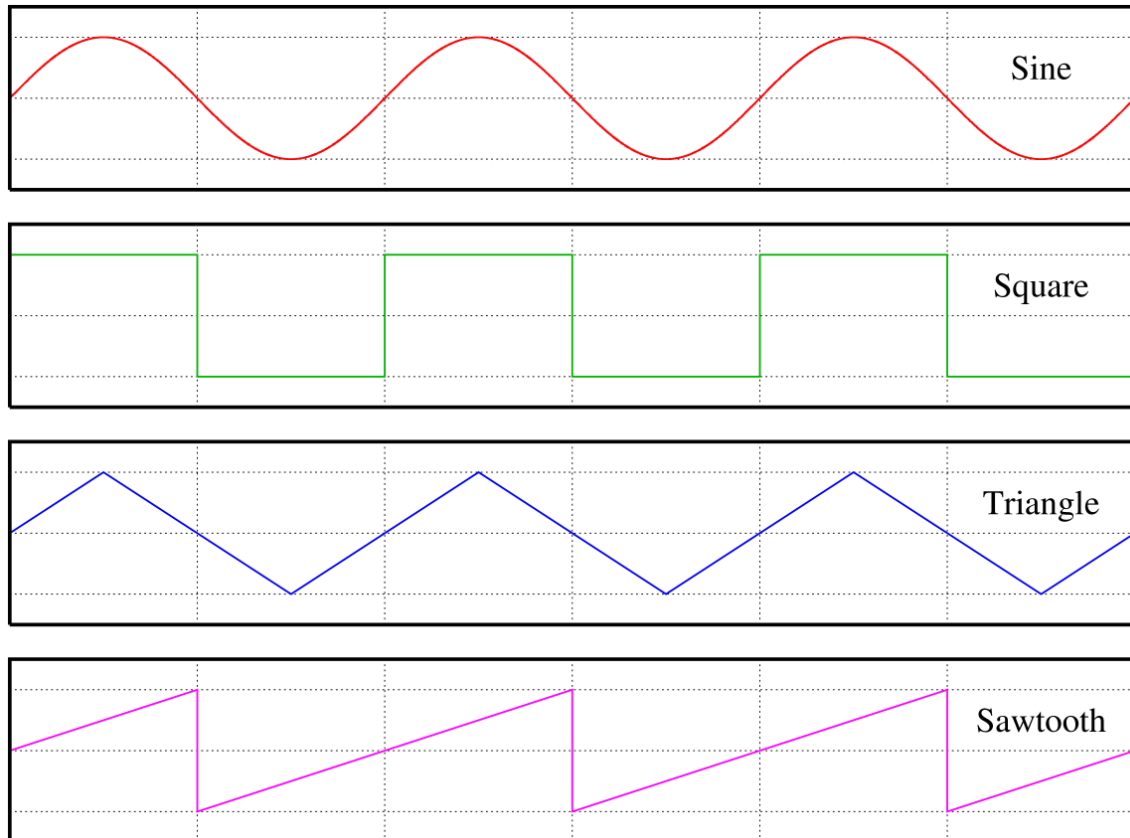

Figure 16

4.24 Classifications

Periodic functions can be classified in a number of ways. one of the ways that they can be classified is according to their symmetry. A function may be Odd, Even, or Neither Even nor Odd. All periodic functions can be classified in this way.

4.24.1 Even

Functions are even if they are symmetrical about the y -axis.

$$f(x) = f(-x)$$

For instance, a cosine function is an even function.

4.24.2 Odd

A function is odd if it is inversely symmetrical about the y -axis.

$$f(x) = -f(-x)$$

The Sine function is an odd function.

4.24.3 Neither Even nor Odd

Some functions are neither even nor odd. However, such functions can be written as a sum of even and odd functions. Any function $f(x)$ can be expressed as a sum of an odd function and an even function:

$$f(x) = 1/2\{f(x) + f(-x)\} + 1/2\{f(x) - f(-x)\}$$

We leave it as an exercise to the reader to verify that the first component is even and that the second component is odd. Note that the first term is zero for odd functions and that the second term is zero for even functions.

5 Frequency Representation

Signals and Systems¹

5.1 The Fourier Series

The Fourier Series is a specialized tool that allows for any periodic signal (subject to certain conditions) to be decomposed into an infinite sum of everlasting sinusoids. This may not be obvious to many people, but it is demonstrable both mathematically and graphically. Practically, this allows the user of the Fourier Series to understand a periodic signal as the sum of various frequency components.

5.2 Rectangular Series

The rectangular series represents a signal as a sum of sine and cosine terms. The type of sinusoids that a periodic signal can be decomposed into depends solely on the qualities of the periodic signal.

5.2.1 Calculations

If we have a function $f(x)$, that is periodic with a period of $2L$, we can decompose it into a sum of sine and cosine functions as such:

$$f(x) = \frac{1}{2}a_0 + \sum_{n=1}^{\infty} [a_n \cos\left(\frac{n\pi x}{L}\right) + b_n \sin\left(\frac{n\pi x}{L}\right)]$$

The coefficients, a and b can be found using the following integrals:

$$a_n = \frac{1}{L} \int_{-L}^L f(x) \cos\left(\frac{n\pi x}{L}\right) dx$$

$$b_n = \frac{1}{L} \int_{-L}^L f(x) \sin\left(\frac{n\pi x}{L}\right) dx$$

" n " is an integer variable. It can assume positive integer numbers (1, 2, 3, etc...). Each value of n corresponds to values for A and B . The sinusoids with magnitudes A and B are called *harmonics*. Using Fourier representation, a harmonic is an atomic (indivisible) component of the signal, and is said to be *orthogonal*. When we set $n = 1$, the resulting sinusoidal frequency value from the above equations is known as the **fundamental frequency**. The fundamental frequency of a given signal is the most powerful sinusoidal component of a signal, and is the most important to transmit faithfully. Since n takes on integer values, all

¹ http://en.wikibooks.org/wiki/Signals_and_Systems

other frequency components of the signal are integer multiples of the fundamental frequency. If we consider a signal in time, the period, T_0 is analogous to $2L$ in the above definition. The fundamental frequency is then given by:

$$f_0 = \frac{1}{T_0}$$

And the fundamental angular frequency is then:

$$\omega_0 = \frac{2\pi}{T_0}$$

Thus we can replace every $(\frac{n\pi x}{L})$ term with a more concise $(n\omega_0 x)$.



The fundamental frequency is the repetition frequency of the periodic signal

5.2.2 Signal Properties

Various signal properties translate into specific properties of the Fourier series. If we can identify these properties before hand, we can save ourselves from doing unnecessary calculations.

DC Offset

If the periodic signal has a DC offset, then the Fourier Series of the signal will include a *zero frequency component*, known as the **DC component**. If the signal does not have a DC offset, the DC component has a magnitude of 0. Due to the linearity of the Fourier series process, if the DC offset is removed, we can analyse the signal further (e.g. for symmetry) and add the DC offset back at the end.

Odd and Even Signals

If the signal is even (symmetric over the reference vertical axis), it is composed of cosine waves. If the signal is odd (anti-symmetric over the reference vertical axis), it is composed out of sine waves. If the signal is neither even nor odd, it is composed out of both sine and cosine waves.

Discontinuous Signal

If the signal is discontinuous (i.e. it has "jumps"), the magnitudes of each harmonic n will fall off proportionally to $1/n$.

Discontinuous Derivative

If the signal is continuous but the derivative of the signal is discontinuous, the magnitudes of each harmonic n will fall off proportionally to $1/n^2$.

Half-Wave Symmetry

If a signal has half-wave symmetry, there is no DC offset, and the signal is composed of sinusoids lying on only the *odd harmonics* (1, 3, 5, etc...). This is important because a signal with half-wave symmetry will require twice as much bandwidth to transmit the same number of harmonics as a signal without:

$$a_0 = 0$$

$$a_n = \begin{cases} 0, & \text{if } n \text{ is even} \\ \frac{2}{L} \int_0^L f(x) \cos(n\omega_0 x) dx, & \text{if } n \text{ is odd} \end{cases}$$

$$b_n = \begin{cases} 0, & \text{if } n \text{ is even} \\ \frac{2}{L} \int_0^L f(x) \sin(n\omega_0 x) dx, & \text{if } n \text{ is odd} \end{cases}$$

Quarter-Wave Symmetry of an Even Signal

If a $2L$ -periodic signal has quarter-wave symmetry, then it must also be half-wave symmetric, so there are no even harmonics. If the signal is even and has quarter-wave symmetry, we only need to integrate the first quarter-period:

$$a_n = \begin{cases} 0, & \text{if } n \text{ is even} \\ \frac{4}{L} \int_0^{L/2} f(x) \cos(n\omega_0 x) dx, & \text{if } n \text{ is odd} \end{cases}$$

We also know that because the signal is half-wave symmetric, there is no DC offset:

$$a_0 = 0$$

Because the signal is even, there are no sine terms:

$$b_n = 0$$

Quarter-Wave Symmetry of an Odd Signal

If the signal is odd, and has quarter wave symmetry, then we can say: Because the signal is odd, there are no cosine terms:

$$a_0 = 0$$

$$a_n = 0$$

There are no even sine terms due to half-wave symmetry, and we only need to integrate the first quarter-period due to quarter-wave symmetry.

$$b_n = \begin{cases} 0, & \text{if } n \text{ is even} \\ \frac{4}{L} \int_0^{L/2} f(x) \sin(n\omega_0 x) dx, & \text{if } n \text{ is odd} \end{cases}$$

5.2.3 Summary

By convention, the coefficients of the cosine components are labeled "a", and the coefficients of the sine components are labeled with a "b". A few important facts can then be mentioned:

- If the function has a DC offset, a_0 will be non-zero. There is no B_0 term.
- If the signal is even, all the b terms are 0 (no sine components).
- If the signal is odd, all the a terms are 0 (no cosine components).
- If the function has half-wave symmetry, then all the even coefficients (of sine and cosine terms) are zero, and we only have to integrate half the signal.
- If the function has quarter-wave symmetry, we only need to integrate a quarter of the signal.
- The Fourier series of a sine or cosine wave contains *a single harmonic* because a sine or cosine wave cannot be decomposed into other sine or cosine waves.
- We can check a series by looking for discontinuities in the signal or derivative of the signal. If there are discontinuities, the harmonics drop off as $1/n$, if the derivative is discontinuous, the harmonics drop off as $1/n^2$.

5.3 Polar Series

The Fourier Series can also be represented in a polar form which is more compact and easier to manipulate. If we have the coefficients of the rectangular Fourier Series, a and b we can define a coefficient x , and a phase angle ϕ that can be calculated in the following manner:

$$\begin{aligned}x_0 &= a_0 \\x_n &= \sqrt{a_n^2 + b_n^2} \\ \phi_n &= \tan^{-1} \left(\frac{b_n}{a_n} \right)\end{aligned}$$

We can then define $f(x)$ in terms of our new Fourier representation, by using a **cosine basis function**:

$$f(x) = x_0 + \sum_{n=1}^{\infty} x_n \cos(n\omega x - \phi_n)$$

The use of a cosine basis instead of a sine basis is an arbitrary distinction, but is important nonetheless. If we wanted to use a sine basis instead of a cosine basis, we would have to modify our equation for ϕ , above.

5.3.1 Proof of Equivalence

We can show explicitly that the polar cosine basis function is equivalent to the "Cartesian" form with a sine and cosine term.

$$f(x) = x_0 + \sum_{n=1}^{\infty} x_n \cos(n\omega x - \phi_n)$$

By the double-angle formula for cosines:

$$f(x) = x_0 + \sum_{n=1}^{\infty} x_n [\cos(n\omega x) \cos(-\phi_n) - \sin(n\omega x) \sin(-\phi_n)]$$

By the odd-even properties of cosines and sines:

$$f(x) = x_0 + \sum_{n=1}^{\infty} x_n [\cos(n\omega x) \cos(\phi_n) + \sin(n\omega x) \sin(\phi_n)]$$

Grouping the coefficients:

$$f(x) = x_0 + \sum_{n=1}^{\infty} [x_n \cos(\phi_n) \cos(n\omega x) + x_n \sin(\phi_n) \sin(n\omega x)]$$

This is equivalent to the rectangular series given that:

$$a_n = x_n \cos(\phi_n)$$

$$b_n = x_n \sin(\phi_n)$$

Dividing, we get:

$$\frac{b_n}{a_n} = \frac{x_n \sin(\phi_n)}{x_n \cos(\phi_n)} = \tan(\phi_n)$$

$$\phi_n = \tan^{-1} \left(\frac{b_n}{a_n} \right)$$

Squaring and adding, we get:

$$a_n^2 + b_n^2 = x_n^2 [\cos^2(\phi_n) + \sin^2(\phi_n)]$$

$$a_n^2 + b_n^2 = x_n^2$$

$$x_n = \sqrt{a_n^2 + b_n^2}$$

Hence, given the above definitions of x_n and φ_n , the two are equivalent. For a sine basis function, just use the sine double-angle formula. The rest of the process is very similar.

5.4 Exponential Series

Using Euler's Equation, and a little trickery, we can convert the standard Rectangular Fourier Series into an exponential form. Even though complex numbers are a little more complicated to comprehend, we use this form for a number of reasons:

1. Only need to perform one integration
2. A single exponential can be manipulated more easily than a sum of sinusoids
3. It provides a logical transition into a further discussion of the Fourier Transform.

We can construct the exponential series from the rectangular series using Euler's formulae:

$$\sin(x) = \frac{-i}{2} (e^{ix} - e^{-ix}); \quad \cos(x) = \frac{1}{2} (e^{ix} + e^{-ix})$$

The rectangular series is given by:

$$f(x) = a_0 + \sum_{n=1}^{\infty} [a_n \cos(n\omega x) + b_n \sin(n\omega x)]$$

Substituting Euler's formulae:

$$f(x) = a_0 + \sum_{n=1}^{\infty} \left[\frac{a_n}{2} e^{in\omega x} + \frac{a_n}{2} e^{-in\omega x} - \frac{ib_n}{2} e^{in\omega x} + \frac{ib_n}{2} e^{-in\omega x} \right]$$

Splitting into "positive n " and "negative n " parts gives us:

$$f(x) = a_0 + \sum_{n=1}^{\infty} \left[\frac{a_n}{2} e^{in\omega x} - \frac{ib_n}{2} e^{in\omega x} \right] + \sum_{n=-\infty}^{-1} \left[\frac{a_{-n}}{2} e^{in\omega x} + \frac{ib_{-n}}{2} e^{in\omega x} \right]$$

$$f(x) = a_0 + \sum_{n=1}^{\infty} \frac{1}{2} (a_n - ib_n) e^{in\omega x} + \sum_{n=-\infty}^{-1} \frac{1}{2} (a_{-n} + ib_{-n}) e^{in\omega x}$$

We now collapse this into a single expression:

[Exponential Fourier Series]

$$f(x) = \sum_{n=-\infty}^{\infty} c_n e^{in\omega x}$$

Where we can relate c_n to a_n and b_n from the rectangular series:

$$c_n = \begin{cases} \frac{1}{2}(a_{-n} + ib_{-n}), & n < 0 \\ a_0, & n = 0 \\ \frac{1}{2}(a_n - ib_n), & n > 0 \end{cases}$$

This is the exponential Fourier series of $f(x)$. Note that c_n is, in general, complex. Also note that:

- $\Re(c_n) = \Re(c_{-n})$
- $\Im(c_n) = -\Im(c_{-n})$

We can directly calculate c_n for a $2L$ -periodic function:

$$c_n = \frac{1}{2L} \int_{-L}^L f(x) e^{-in\pi x/L} dx$$

This can be related to the a_n and b_n definitions in the rectangular form using Euler's formula: $e^{ix} = \cos x + i \sin x$.

5.5 Negative Frequency

The Exponential form of the Fourier series does something that is very interesting in comparison to the rectangular and polar forms of the series: it allows for negative frequency components. To this effect, the Exponential series is often known as the "Bi-Sided Fourier Series", because the spectrum has both a positive and negative side. This, of course, prods the question, "What is a negative Frequency?" Negative frequencies seem counter-intuitive, and many people would be quick to dismiss them as being nonsense. However, a further study of electrical engineering (which is outside the scope of this book) will provide many examples of where negative frequencies play a very important part in modeling and understanding certain systems. While it may not make much sense initially, negative frequencies need to be taken into account when studying the Fourier Domain. Negative frequencies follow the important rule of symmetry: For real signals, negative frequency components are *always* mirror-images of the positive frequency components. Once this rule is learned, drawing the negative side of the spectrum is a trivial matter once the positive side has been drawn. However, when looking at a bi-sided spectrum, the effect of negative frequencies needs to be taken into account. If the negative frequencies are mirror-images of the positive frequencies, and if a negative frequency is analogous to a positive frequency, then the effect of adding the negative components into a signal is the same as doubling the positive components. This is a major reason why the exponential Fourier series coefficients are multiplied by one-half in the calculation: because half the coefficient is at the negative frequency. Note: The concept of negative frequency is actually unphysical. Negative frequencies occur in the spectrum only when we are using the exponential form of the Fourier series. To represent a cosine function, Euler's relationship tells us that there are both positive and negative exponential required. Why? Because to represent a real function, like cosine, the imaginary components present in exponential notation must vanish. Thus, the negative exponent in Euler's formula makes it appear that there are negative frequencies, when in fact, there are not.

5.5.1 Example: Ceiling Fan

Another way to understand negative frequencies is to use them for mathematical completeness in describing the physical world. Suppose we want to describe the rotation of a ceiling fan directly above our head to a person sitting nearby. We would say "it rotates at 60 RPM in an anticlockwise direction". However, if we want to describe its rotation to a person watching the fan from above then we would say "it rotates at 60 RPM in a clockwise direction". If we customarily use a negative sign for clockwise rotation, then we would use a positive sign for anticlockwise rotation. We are describing the same process using both positive and negative signs, depending on the reference we choose.

5.6 Bandwidth

Bandwidth is the name for the frequency range that a signal requires for transmission, and is also a name for the frequency capacity of a particular transmission medium. For example, if a given signal has a bandwidth of 10kHz, it requires a transmission medium with a bandwidth of *at least* 10kHz to transmit without attenuation. Bandwidth can be measured in either Hertz or Radians per Second. Bandwidth is only a measurement of the positive frequency components. All real signals have negative frequency components, but since they are only mirror images of the positive frequency components, they are not included in bandwidth calculations.

5.6.1 Bandwidth Concerns

It's important to note that most periodic signals are composed of *an infinite sum* of sinusoids, and therefore require an infinite bandwidth to be transmitted without distortion. Unfortunately, no available communication medium (wire, fiber optic, wireless) have an infinite bandwidth available. This means that certain harmonics will pass through the medium, while other harmonics of the signal will be attenuated. Engineering is all about trade-offs. The question here is "How many harmonics do I *need* to transmit, and how many can I safely get rid of?" Using fewer harmonics leads to reduced bandwidth requirements, but also results in increased signal distortion. These subjects will all be considered in more detail in the future.

5.6.2 Pulse Width

Using our relationship between period and frequency, we can see an important fact:

$$f_0 = \frac{1}{T}$$

As the period of the signal *decreases*, the fundamental frequency increases. This means that each additional harmonic will be spaced further apart, and transmitting the same number of harmonics will now require more bandwidth! In general, there is a rule that must be followed when considering periodic signals: *Shorter periods in the time domain require more bandwidth in the frequency domain. Signals that use less bandwidth in the frequency domain will require longer periods in the time domain.*

5.7 Examples

5.7.1 Example: x^3

Let's consider a repeating pattern based on a cubic polynomial:

$$f(x) = x^3, \quad -\pi \leq x < \pi$$

and $f(x)$ is 2π periodic:

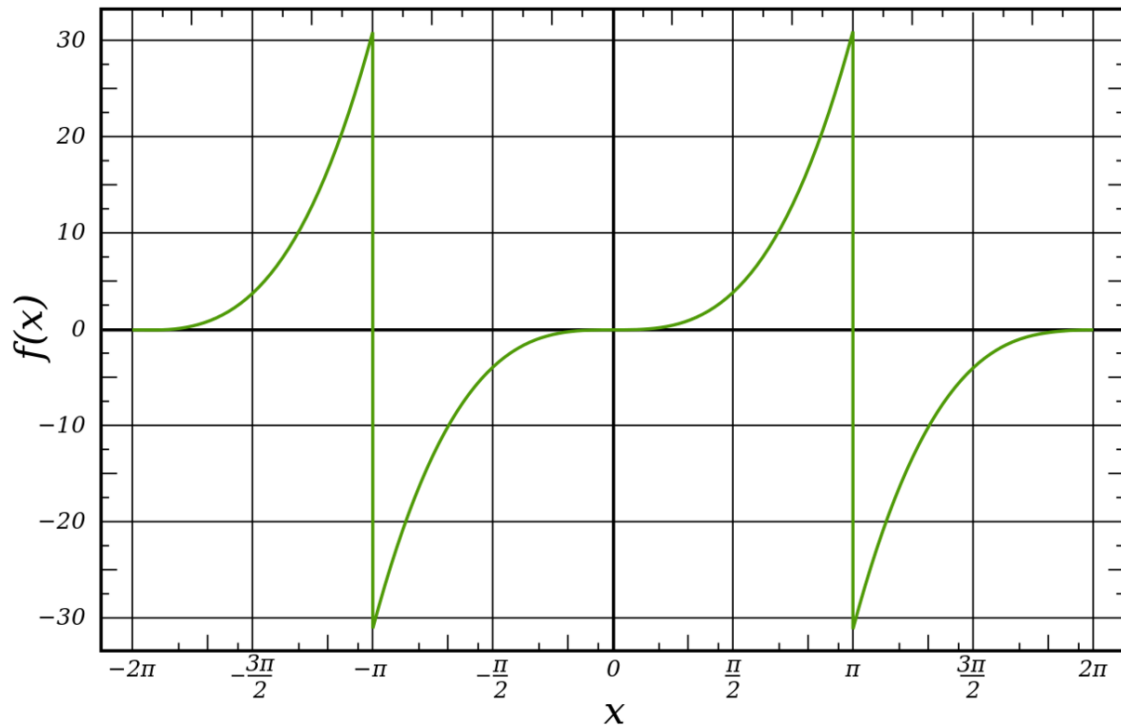

Figure 18

By inspection, we can determine some characteristics of the Fourier Series:

- The function is odd, so the cosine coefficients (a_n) will all be zero.
- The function has no DC offset, so there will be no constant term (a_0).
- There are discontinuities, so we expect a $1/n$ drop-off.

We therefore just have to compute the b_n terms. These can be found by the following formula:

$$b_n = \frac{1}{\pi} \int_{-\pi}^{\pi} f(x) \sin(nx) dx$$

Substituting in the desired function gives

$$b_n = \frac{1}{\pi} \int_{-\pi}^{\pi} x^3 \sin(nx) dx$$

Integrating by parts,

$$b_n = \frac{1}{\pi} \left(\left[-x^3 \frac{\cos(nx)}{n} \right]_{-\pi}^{\pi} + \int_{-\pi}^{\pi} 3x^2 \frac{\cos(nx)}{n} dx \right)$$

Bring out factors:

$$b_n = \frac{1}{n\pi} \left(\left[-x^3 \cos(nx) \right]_{-\pi}^{\pi} + 3 \int_{-\pi}^{\pi} x^2 \cos(nx) dx \right)$$

Substitute limits into the square brackets and integrate by parts again:

$$b_n = \frac{1}{n\pi} \left(-(\pi^3 \cos(n\pi) + \pi^3 \cos(-n\pi)) + 3 \left(\left[x^2 \frac{\sin(nx)}{n} \right]_{-\pi}^{\pi} - \int_{-\pi}^{\pi} 2x \frac{\sin(nx)}{n} dx \right) \right)$$

Recall that $\cos(x)$ is an even function, so $\cos(-n\pi) = \cos(n\pi)$. Also bring out the factor of $1/n$ from the integral:

$$b_n = \frac{1}{n\pi} \left(-(\pi^3 \cos(n\pi) + \pi^3 \cos(n\pi)) + \frac{3}{n} \left(\left[x^2 \sin(nx) \right]_{-\pi}^{\pi} - 2 \int_{-\pi}^{\pi} x \sin(nx) dx \right) \right)$$

Simplifying the left part, and substituting in limits in the square brackets,

$$b_n = \frac{1}{n\pi} \left(-2\pi^3 \cos(n\pi) + \frac{3}{n} \left((\pi^2 \sin(n\pi) - \pi \sin(-n\pi)) - 2 \int_{-\pi}^{\pi} x \sin(nx) dx \right) \right)$$

Recall that $\sin(n\pi)$ is always equal to zero for integer n :

$$b_n = \frac{1}{n\pi} \left(-2\pi^3 \cos(n\pi) + \frac{3}{n} \left(0 - 2 \int_{-\pi}^{\pi} x \sin(nx) dx \right) \right)$$

Bringing out factors and integrating by parts:

$$b_n = \frac{1}{n\pi} \left(-2\pi^3 \cos(n\pi) - \frac{6}{n} \left[- \left[x \frac{\cos(nx)}{n} \right]_{-\pi}^{\pi} + \int_{-\pi}^{\pi} \frac{\cos(nx)}{n} dx \right] \right)$$

$$b_n = \frac{1}{n\pi} \left(-2\pi^3 \cos(n\pi) - \frac{6}{n^2} \left[-[x \cos(nx)]_{-\pi}^{\pi} + \int_{-\pi}^{\pi} \cos(nx) dx \right] \right)$$

Solving the now-simple integral and substituting in limits to the square brackets,

$$b_n = \frac{1}{n\pi} \left(-2\pi^3 \cos(n\pi) - \frac{6}{n^2} \left[-(\pi \cos(n\pi) + \pi \cos(-n\pi)) + [\sin(nx)]_{-\pi}^{\pi} \right] \right)$$

Since the area under one cycle of a sine wave is zero, we can eliminate the integral. We use the fact that $\cos(x)$ is even again to simplify:

$$b_n = \frac{1}{n\pi} \left(-2\pi^3 \cos(n\pi) - \frac{6}{n^2} [-2\pi \cos(n\pi) + 0] \right)$$

Simplifying:

$$b_n = \frac{1}{n\pi} \left(-2\pi^3 \cos(n\pi) + \frac{12\pi}{n^2} \cos(n\pi) \right)$$

$$b_n = \frac{-2\pi^2 \cos(n\pi)}{n} + \frac{12 \cos(n\pi)}{n^3}$$

$$b_n = \cos(n\pi) \left(\frac{-2\pi^2 n^2}{n^3} + \frac{12}{n^3} \right)$$

$$b_n = \frac{-2 \cos(n\pi)}{n^3} (\pi^2 n^2 - 6)$$

Now, use the fact that $\cos(n\pi) = (-1)^n$:

$$b_n = \frac{-2(-1)^n}{n^3} (\pi^2 n^2 - 6)$$

This is our final b_n . We see that we have a approximate $1/n$ relationship (the constant "6" becomes insignificant as n grows), as we expected. Now, we can find the Fourier approximation according to

$$f(x) = \frac{1}{2}a_0 + \sum_{n=1}^{\infty} [a_n \cos(nx) + b_n \sin(nx)]$$

Since all a terms are zero,

$$f(x) = \sum_{n=1}^{\infty} b_n \sin(nx)$$

So, the Fourier Series approximation of $f(x) = x^3$ is:

$$f(x) = \sum_{n=1}^{\infty} \left[\frac{-2(-1)^n}{n^3} (\pi^2 n^2 - 6) \sin(nx) \right]$$

The graph below shows the approximation for the first 7 terms (red) and the first 15 terms (blue). The original function is shown in black.

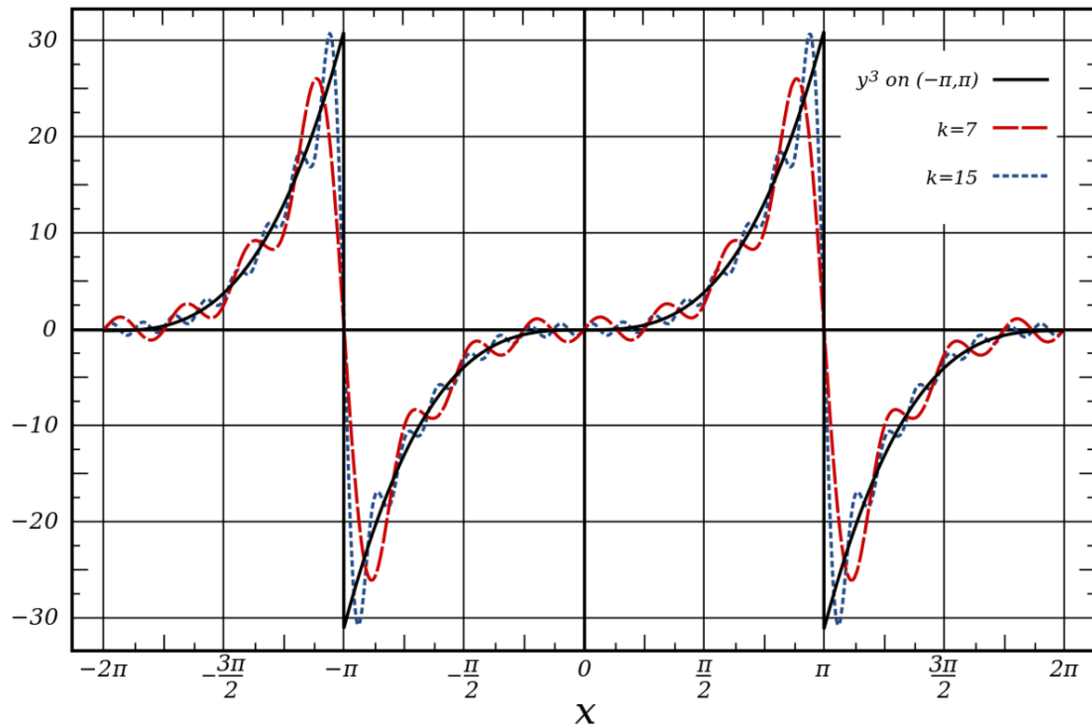
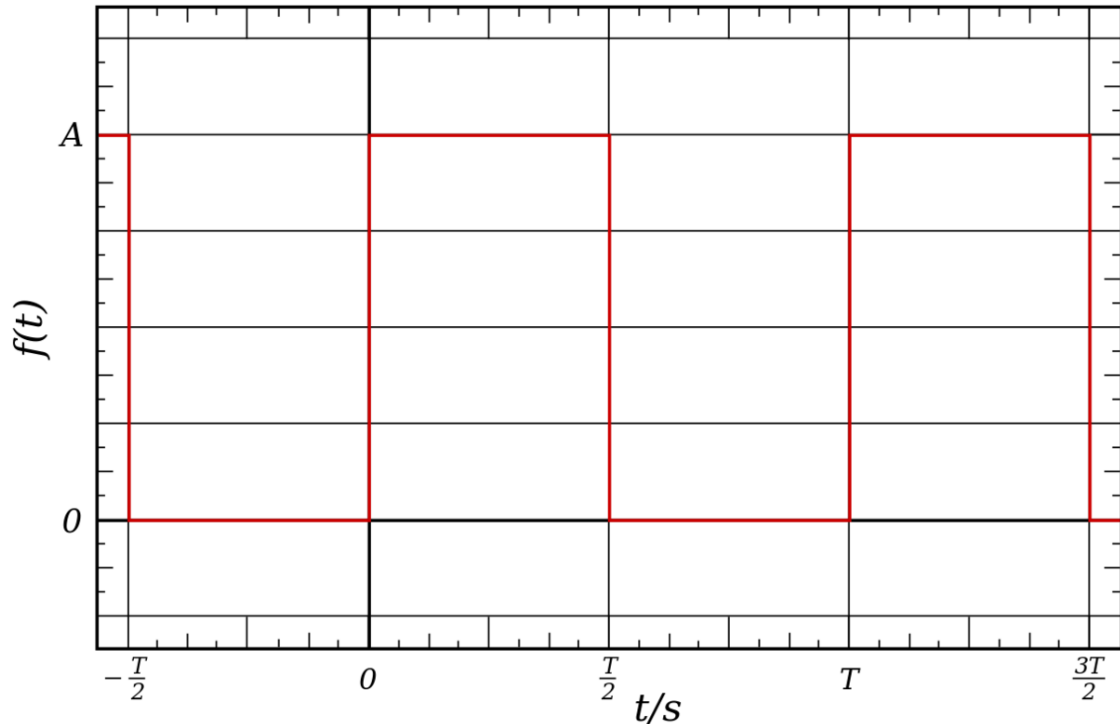

Figure 19

5.7.2 Example: Square Wave

We have the following square wave signal, as a function of voltage, traveling through a communication medium:

Figure 20

We will set the values as follows: $A = 4$ volts, $T = 1$ second. Also, it is given that the width of a single pulse is $T/2$. Find the rectangular Fourier series of this signal. First and foremost, we can see clearly that this signal does have a DC value: the signal exists entirely above the horizontal axis. DC value means that we will have to calculate our a_0 term. Next, we can see that if we remove the DC component (shift the signal downward till it is centered around the horizontal axis), that our signal is an odd signal. This means that we will have b_n terms, but no a_n terms. We can also see that this function has discontinuities and half-wave symmetry. Let's recap:

1. DC value (must calculate a_0)
2. Odd Function ($a_n = 0$ for $n > 0$)
3. Discontinuities (terms fall off as $1/n$)
4. Half-wave Symmetry (no even harmonics)

Now, we can calculate these values as follows:

$$a_0 = \frac{1}{T} \int_0^T f(t) dt$$

$$a_0 = \frac{1}{T} \int_0^{T/2} 4 dt$$

$$a_0 = \frac{1}{T} [4t]_0^{T/2} = \frac{4 \times T}{T \times 2} = 2$$

This could also have been worked out intuitively, as the signal has a 50% duty-cycle, meaning that the average value is half of the maximum. Due to the oddness of the function, there are no cosine terms:

$$a_n = 0 \quad \text{for all } n > 0.$$

Due to the half-wave symmetry, there are only odd sine terms, which are given by:

$$b_n = \frac{1}{T/2} \int_0^T f(t) \sin\left(\frac{2n\pi t}{T}\right) dt$$

$$b_n = \frac{2}{T} \int_0^{T/2} 4 \sin(2n\pi t) dt$$

$$b_n = -2 \left[\frac{4}{2n\pi} \cos(2n\pi t) \right]_0^{1/2}$$

$$b_n = -2 \left[\frac{4}{2n\pi} \cos\left(\frac{2n\pi}{2}\right) - \frac{4}{2n\pi} \cos(2n\pi \times 0) \right]$$

$$b_n = -\frac{4}{n\pi} [\cos(n\pi) - 1]$$

Given that $\cos(n\pi) = (-1)^n$:

$$b_n = -\frac{4((-1)^n - 1)}{n\pi}$$

For any even n , this equals zero, in accordance with our predictions based on half-wave symmetry. It also decays as $1/n$, as we expect, due to the presence of discontinuities. Finally, we can put our Fourier series together as follows:

$$f(t) = a_0 + \sum_{n=1}^{\infty} b_n \sin\left(\frac{\pi n t}{L/2}\right)$$

$$f(t) = 2 - \frac{4}{\pi} \sum_{n=1}^{\infty} \frac{(-1)^n - 1}{n} \sin(2\pi n t)$$

This is the same as

$$f(t) = 2 + \frac{8}{\pi} \sum_{n=1,3,5,\dots}^{\infty} \frac{1}{n} \sin(2\pi n t)$$

We see that the Fourier series closely matches the original function:

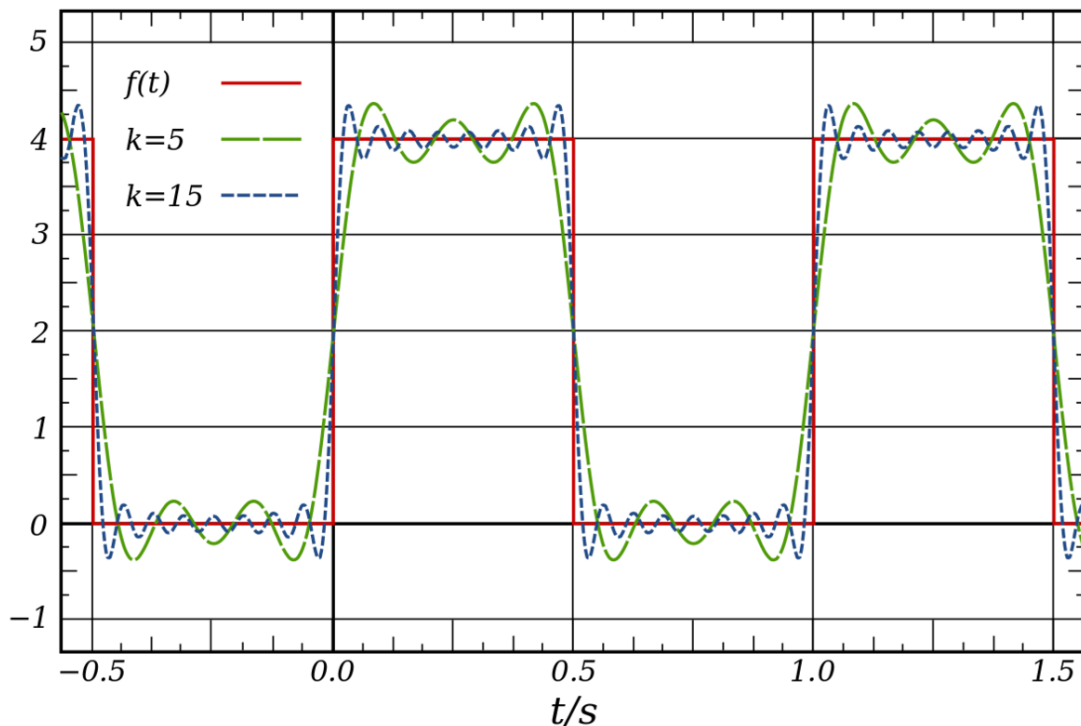

Figure 21

5.8 Further Reading

Wikipedia² has related information at *Fourier series*³

Wikipedia has an article on the Fourier Series, although the article is very mathematically rigorous.

Signals and Systems⁴

5.9 Periodic Inputs

5.9.1 System Response

5.10 Plotting Results

From the polar form of the Fourier series, we can see that essentially, there are 2 quantities that that Fourier series provides: Magnitude, and Phase shift. If we simplify the entire series into the polar form, we can see that instead of being an infinite sum of different sinusoids, we get simply an infinite sum of cosine waves, with varying magnitude and phase parameters. This makes the entire series easier to work with, and also allows us to begin working with different graphical methods of analysis.

5.10.1 Magnitude Plots

It is important to remember at this point that the Fourier series turns a continuous, periodic time signal into a discrete set of frequency components. In essence, any plot of Fourier components will be a *stem* plot, and will not be continuous. The user should never make the mistake of attempting to **interpolate** the components into a smooth graph. The magnitude graphs of a Fourier series representation plots the magnitude of the coefficient (either X_n in polar, or C_n in exponential form) against the frequency, in radians per second. The X-axis will have the independent variable, in this case the frequency. The Y-axis will hold the magnitude of each component. The magnitude can be a measure of either current or voltage, depending on how the original signal was represented. Keep in mind, however, that most signals, and their resulting magnitude plots, are discussed in terms of voltage (not current).

5.10.2 Phase Plots

Similar to the magnitude plots, the phase plots of the Fourier representation will graph the phase angle of each component against the frequency. Both the frequency (X-axis), and the phase angle (Y-axis) will be plotted in units of radians per seconds. Occasionally, Hertz

2 <http://en.wikibooks.org/en.wikipedia.org/wiki/>

3 http://en.wikibooks.org/en.wikipedia.org/wiki/Fourier_series

4 http://en.wikibooks.org/wiki/Signals_and_Systems

may be used for one (or even both), but this is not the normal case. Like the magnitude plot, the phase plot of a Fourier series will be discrete, and should be drawn as individual points, not as smooth lines.

5.11 Power

Frequently, it is important to talk about the **power** in a given periodic wave. It is also important to talk about how much power is being transmitted in each different harmonic. For instance, if a certain channel has a limited bandwidth, and is filtering out some of the harmonics of the signal, then it is important to know how much power is being removed from the signal by the channel.

5.11.1 Normalization

Let us now take a look at our equation for power:

$$P = iv$$

Ohm's Law:

$v = ir$ If we use Ohm's Law to solve for v and i respectively, and then plug those values into our equation, we will get the following result:

$$P = i^2R = \frac{v^2}{R}$$

If we **normalize** the equation, and set $R = 1$, then both equations become much easier. In any case where the words "normalized power" are used, it denotes the fact that we are using a normalized resistance ($R = 1$). To "de-normalize" the power, and find the power loss across a load with a non-normalized resistance, we can simply divide by the resistance (when in terms of voltage), and multiply by the resistance (when in terms of current).

5.11.2 Power Plots

Because of the above result, we can assume that all loads are normalized, and we can find the power in a signal simply by squaring the signal itself. In terms of Fourier Series harmonics, we square the magnitude of each harmonic separately to produce the **power spectrum**. The power spectrum shows us how much power is in each harmonic.

5.12 Parseval's Theorem

If the Fourier Representation and the Time-Domain Representation are simply two different ways to consider the same set of information, then it would make sense that the two are equal in many ways. The power and energy in a signal when expressed in the time domain should be equal to the power and energy of that same signal when expressed in the frequency domain. **Parseval's Theorem** relates the two. Parseval's theorem states that the power

calculated in the time domain is the same as the power calculated in the frequency domain. There are two ways to look at Parseval's Theorem, using the one-sided (polar) form of the Fourier Series, and using the two-sided (exponential) form:

$$P = \int_0^T f^2(t)dt = X_0^2 + \sum_{n=1}^{\infty} \frac{X_n^2}{2}$$

and

$$P = \sum_{-\infty}^{\infty} C_n C_{-n} = \sum_{-\infty}^{\infty} |C_n|^2$$

By changing the upper-bound of the summation in the frequency domain, we can limit the power calculation to a limited number of harmonics. For instance, if the channel bandwidth limited a particular signal to only the first 5 harmonics, then the upper-bound could be set to 5, and the result could be calculated.

5.13 Energy Spectrum

With Parseval's theorem, we can calculate the amount of energy being used by a signal in different parts of the spectrum. This is useful in many applications, such as filtering, that we will discuss later. We know from Parseval's theorem that to obtain the energy of the harmonics of the signal that we need to square the frequency representation in order to view the energy. We can define the **energy spectral density** of the signal as the square of the Fourier transform of the signal:

$$\mathcal{E}_F(\theta) = \mathcal{F}^2(\theta)$$

The magnitude of the graph at different frequencies represents the amount energy located within those frequency components.

5.14 Power Spectral Density

Akin to energy in a signal is the amount of power in a signal. To find the power spectrum, or **power spectral density** (PSD) of a signal, take the Fourier Transform of the Auto Correlation of the signal(which is in frequency domain).

5.15 Signal to Noise Ratio

In the presence of noise, it is frequently important to know what is the ratio between the signal (which you want), and the noise (which you don't want). The ratio between the noise and the signal is called the **Signal to Noise Ratio**, and is abbreviated with the letters **SNR**. There are actually 2 ways to represent SNR, one as a straight-ratio, and one in decibels. The two terms are functionally equivalent, although since they are different quantities, they cannot be used in the same equations. It is worth emphasizing that decibels cannot be used in calculations the same way that ratios are used.

$$SNR = \frac{Signal}{Noise}$$

Here, the SNR can be in terms of either power or voltage, so it must be specified which quantity is being compared. Now, when we convert SNR into decibels:

$$SNR_{db} = 10 \log_{10} \left(\frac{Signal}{Noise} \right)$$

For instance, an SNR of 3db means that the signal is twice as powerful as the noise signal. A higher SNR (in either representation) is always preferable.

Signals and Systems⁵

Wikipedia⁶ has related information at *Fourier transform*⁷

5.16 Aperiodic Signals

The opposite of a periodic signal is an **aperiodic signal**. An aperiodic function never repeats, although technically an aperiodic function can be considered like a periodic function with an infinite period.

5.17 Background

If we consider aperiodic signals, it turns out that we can generalize the Fourier Series sum into an integral named the **Fourier Transform**. The Fourier Transform is used similarly to the Fourier Series, in that it converts a time-domain function into a frequency domain representation. However, there are a number of differences:

1. Fourier Transform can work on Aperiodic Signals.
2. Fourier Transform is an infinite sum of **infinitesimal sinusoids**.
3. Fourier Transform has an *inverse transform*, that allows for conversion from the frequency domain back to the time domain.

5.18 Fourier Transform

This operation can be performed using this MATLAB⁸ command:

fft

The Fourier Transform is the following integral:

$$\mathcal{F}(f(t)) = F(j\omega) = \int_{-\infty}^{\infty} f(t) e^{-j\omega t} dt$$

⁵ http://en.wikibooks.org/wiki/Signals_and_Systems

⁶ <http://en.wikibooks.org//en.wikipedia.org/wiki/>

⁷ http://en.wikibooks.org//en.wikipedia.org/wiki/Fourier_transform

⁸ http://en.wikibooks.org/wiki/MATLAB_Programming

5.19 Inverse Fourier Transform

And the inverse transform is given by a similar integral:

$$\mathcal{F}^{-1}\{F(j\omega)\} = f(t) = \frac{1}{2\pi} \int_{-\infty}^{\infty} F(j\omega)e^{j\omega t} d\omega$$

Using these formulas, time-domain signals can be converted to and from the frequency domain, as needed.

5.19.1 Partial Fraction Expansion

One of the most important tools when attempting to find the inverse fourier transform is the **Theory of Partial Fractions**. The theory of partial fractions allows a complicated fractional value to be decomposed into a sum of small, simple fractions. This technique is highly important when dealing with other transforms as well, such as the Laplace transform and the Z-Transform.

A reader requests expansion of this page to include more material.

You can help by adding new material⁹ (*learn how*¹⁰) or ask for assistance in the reading room¹¹.

5.20 Duality

The Fourier Transform has a number of special properties, but perhaps the most important is the property of **duality**. We will use a "double-arrow" signal to denote duality. If we have an even signal f , and it's fourier transform F , we can show duality as such:

$$f(t) \Leftrightarrow F(j\omega)$$

This means that the following rules hold true:

$$\mathcal{F}\{f(t)\} = F(j\omega) \text{ AND } \mathcal{F}\{F(t)\} = f(j\omega)$$

Notice how in the second part we are taking the *transform of the transformed equation*, except that we are starting in the time domain. We then convert to the original time-domain representation, except using the frequency variable. There are a number of results of the Duality Theorem.

5.20.1 Convolution Theorem

The **Convolution Theorem** is an important result of the duality property. The convolution theorem states the following:

9 http://en.wikibooks.org/en.wikibooks.org/w/index.php?title=Signals_and_Systems/

Print_version&action=edit

10 http://en.wikibooks.org/wiki/Using_Wikibooks

11 <http://en.wikibooks.org/wiki/Wikibooks:PROJECTS>

Convolution Theorem

Convolution in the time domain is multiplication in the frequency domain. Multiplication in the time domain is convolution in the frequency domain.

Or, another way to write it (using our new notation) is such:

$$A \times B \Leftrightarrow A * B$$

5.20.2 Signal Width

Another principle that must be kept in mind is that signal-widths in the time domain, and bandwidth in the frequency domain are related. This can be summed up in a single statement:

Thin signals in the time domain occupy a wide bandwidth. Wide signals in the time domain occupy a thin bandwidth.

This conclusion is important because in modern communication systems, the goal is to have thinner (and therefore more frequent) pulses for increased data rates, however the consequence is that a large amount of bandwidth is required to transmit all these fast, little pulses.

5.21 Power and Energy

5.21.1 Energy Spectral Density

Unlike the Fourier Series, the Fourier Transform does not provide us with a number of discrete harmonics that we can add and subtract in a discrete manner. If our channel bandwidth is limited, in the Fourier Series representation, we can simply *remove* some harmonics from our calculations. However, in a continuous spectrum, we do not have individual harmonics to manipulate, but we must instead examine the entire continuous signal. The Energy Spectral Density (ESD) of a given signal is the square of its Fourier transform. By definition, the ESD of a function $f(t)$ is given by $F^2(j\omega)$. The power over a given range (a limited bandwidth) is the integration under the ESD graph, between the cut-off points. The ESD is often written using the variable $E_f(j\omega)$.

$$E_f(j\omega) = F^2(j\omega)$$

5.21.2 Power Spectral Density

The **Power Spectral Density** (PSD) is similar to the ESD. It shows the distribution of power in the spectrum of a particular signal.

$$P_f(j\omega) = \int_{-\infty}^{\infty} F(j\omega) d\omega$$

Power spectral density and the autocorrelation form a Fourier Transform duality pair. This means that:

$$P_f(j\omega) = \mathcal{F}[R_{ff}(t)]$$

If we know the autocorrelation of the signal, we can find the PSD by taking the Fourier transform. Similarly, if we know the PSD, we can take the inverse Fourier transform to find the autocorrelation signal.

Signals and Systems¹²

5.22 Frequency Response

Systems respond differently to inputs of different frequencies. Some systems may amplify components of certain frequencies, and attenuate components of other frequencies. The way that the system output is related to the system input for different frequencies is called the *frequency response* of the system. The frequency response is the relationship between the system input and output in the Fourier Domain.

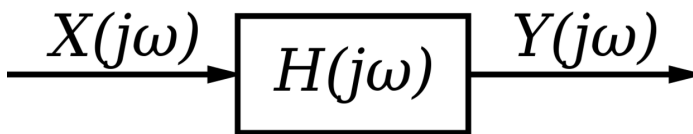

Figure 22

In this system, $X(j\omega)$ is the system input, $Y(j\omega)$ is the system output, and $H(j\omega)$ is the frequency response. We can define the relationship between these functions as:

$$Y(j\omega) = H(j\omega)X(j\omega)$$

$$\frac{Y(j\omega)}{X(j\omega)} = H(j\omega)$$

5.23 The Frequency Response Functions

Since the frequency response is a complex function, we can convert it to polar notation in the complex plane. This will give us a magnitude and an angle. We call the angle the *phase*.

5.23.1 Amplitude Response

For each frequency, the magnitude represents the system's tendency to amplify or attenuate the input signal.

$$A(\omega) = |H(j\omega)|$$

¹² http://en.wikibooks.org/wiki/Signals_and_Systems

5.23.2 Phase Response

The phase represents the system's tendency to modify the phase of the input sinusoids.

$$\phi(\omega) = \angle H(j\omega).$$

The phase response, or its derivative the group delay, tells us how the system delays the input signal as a function of frequency.

5.24 Examples

5.24.1 Example: Electric Circuit

Consider the following general circuit with phasor input and output voltages:

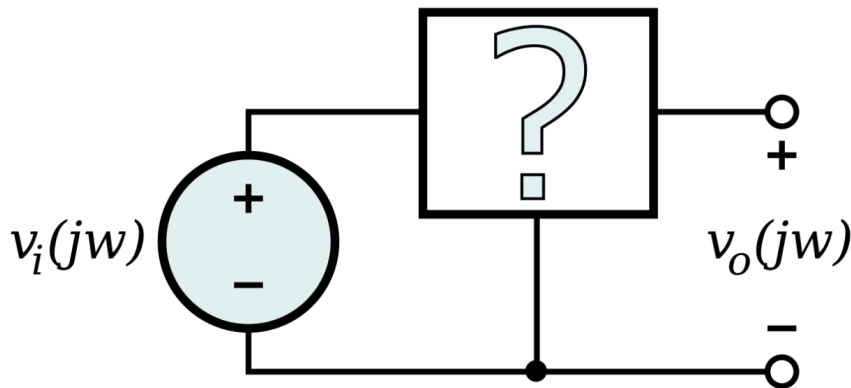

Figure 23

Where

$$V_o(j\omega) = V_{om} \cos(\omega t + \theta_o) = V_{om} \angle \theta_o$$

$$V_i(j\omega) = V_{im} \cos(\omega t + \theta_i) = V_{im} \angle \theta_i$$

As before, we can define the system function, $H(j\omega)$ of this circuit as:

$$H(j\omega) = \frac{V_o(j\omega)}{V_i(j\omega)}$$

$$A(\omega) = |H(j\omega)| = \frac{|V_o(j\omega)|}{|V_i(j\omega)|} = \frac{V_{om}}{V_{im}}$$

$$\phi(\omega) = \angle H(j\omega) = \angle \left(\frac{V_o(j\omega)}{V_i(j\omega)} \right) = \angle V_o(j\omega) - \angle V_i(j\omega) = \theta_o - \theta_i$$

Rearranging gives us the following transformations:

$$V_{om} = A(\omega) V_{im}$$

$$\theta_o = \theta_i + \phi(\omega)$$

5.24.2 Example: Low-Pass Filter

We will illustrate this method using a simple low-pass filter with general values as an example. This kind of circuit allows low frequencies to pass, but blocks higher ones. Find the frequency response function, and hence the amplitude and phase response functions, of the following RC circuit (it is already in phasor form):

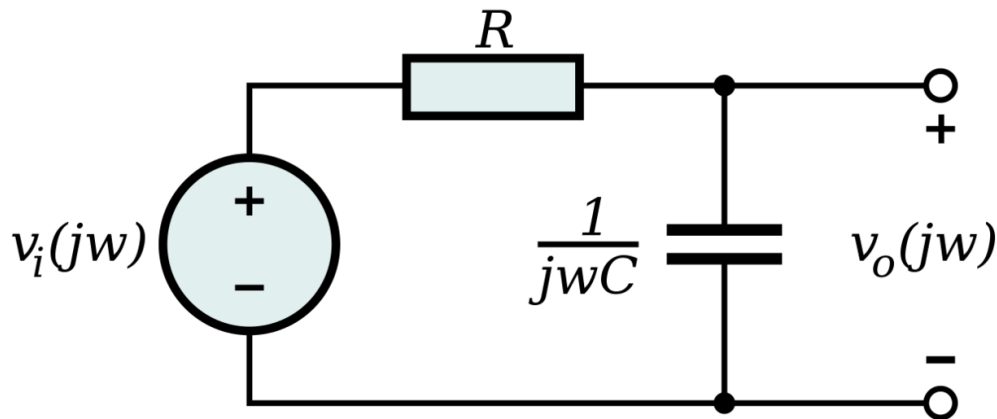

Figure 24

Firstly, we use the voltage divider rule to get the output phasor in terms on the input phasor:

$$V_o(j\omega) = V_i(j\omega) \cdot \frac{\frac{1}{j\omega C}}{R + \frac{1}{j\omega C}}$$

Now we can easily determine the frequency response:

$$H(j\omega) = \frac{V_o(j\omega)}{V_i(j\omega)} = \frac{\frac{1}{j\omega C}}{R + \frac{1}{j\omega C}}$$

This simplifies down to:

$$H(j\omega) = \frac{1}{1 + j\omega RC}$$

From here we can find the amplitude and phase responses:

$$A(\omega) = |H(j\omega)| = \frac{1}{\sqrt{1+(\omega CR)^2}}$$

$$\phi(\omega) = \angle H(j\omega) = \tan^{-1}\left(\frac{0}{1}\right) - \tan^{-1}\left(\frac{\omega RC}{1}\right) = -\tan^{-1}(\omega RC)$$

The frequency response is pictured by the plots of the amplitude and phase responses:

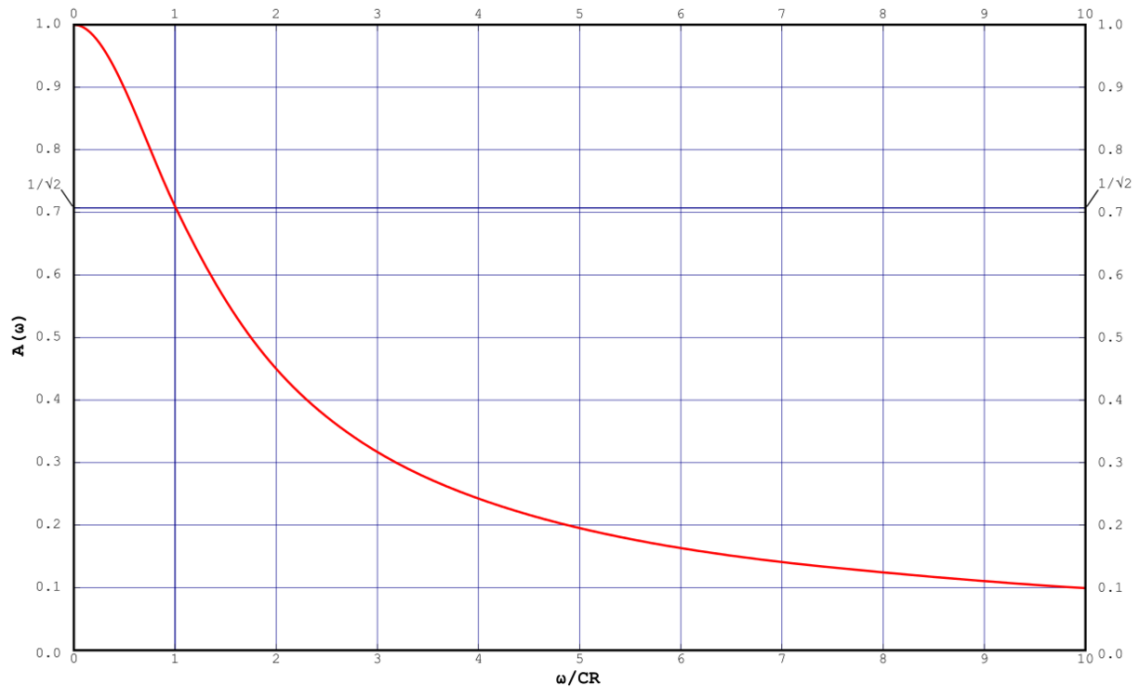

Figure 25

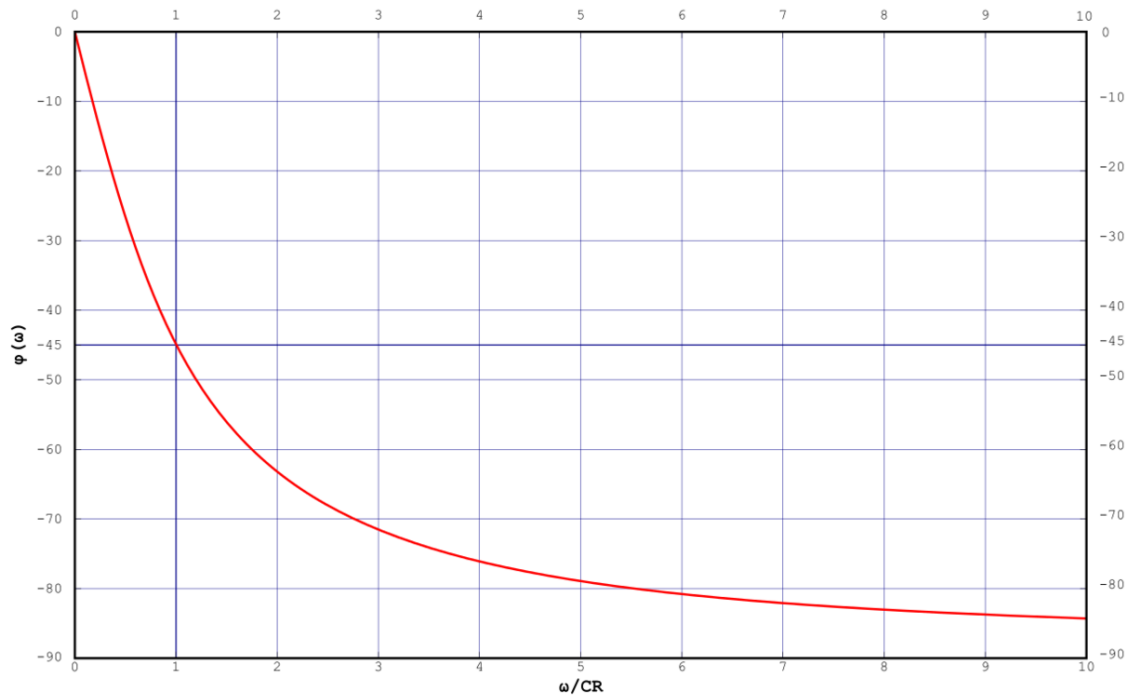

Figure 26

It is often easier to interpret the graphs when they are plotted on suitable logarithmic scales:

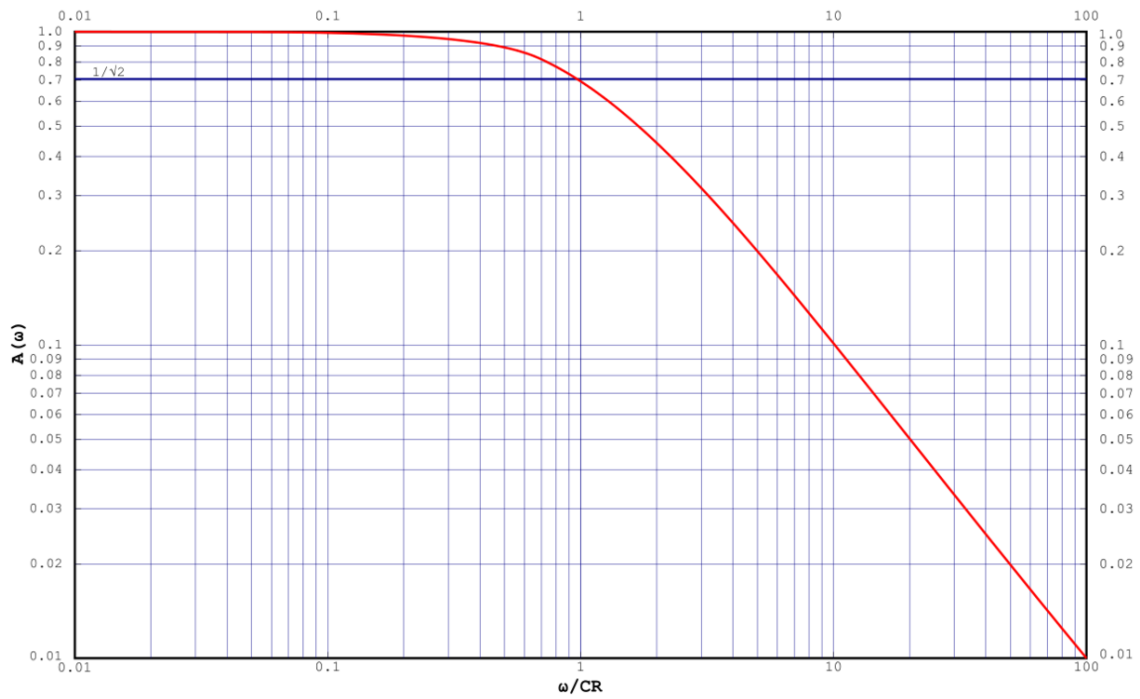

Figure 27

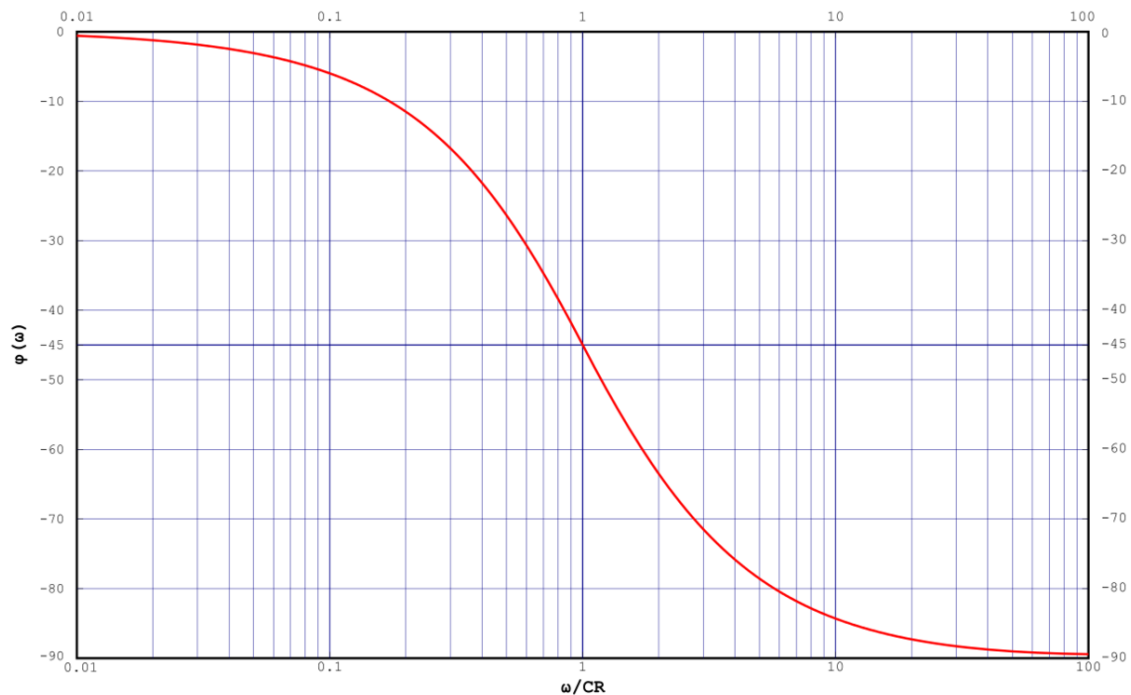

Figure 28

This shows that the circuit is indeed a filter that removes higher frequencies. Such a filter is called a *lowpass filter*. The amplitude and phase responses of an arbitrary circuit can be plotted using an instrument called a **spectrum analyser** or **gain and phase test set**. See Practical Electronics¹³ for more details on using these instruments.

5.25 Filters

An important concept to take away from these examples is that by designing a proper system called a **filter**, we can selectively attenuate or amplify certain frequency ranges. This means that we can minimize certain unwanted frequency components (such as noise or competing data signals), and maximize our own data signal. We can define a "received signal" r as a combination of a data signal d and unwanted components v :

$$r(t) = d(t) + v(t)$$

We can take the energy spectral density of r to determine the frequency ranges of our data signal d . We can design a filter that will attempt to amplify these frequency ranges, and attenuate the frequency ranges of v . We will discuss this problem and filters in general in the next few chapters. More advanced discussions of this topic will be in the book on Signal Processing¹⁴.

¹³ http://en.wikibooks.org/wiki/Practical_Electronics

¹⁴ http://en.wikibooks.org/wiki/Signal_Processing

6 Complex Frequency Representation

6.1 The Laplace Transform

Whilst the Fourier Series¹ and the Fourier Transform² are well suited for analysing the frequency content of a signal, be it periodic or aperiodic, the Laplace transform is the tool of choice for analysing and developing circuits such as filters. The Fourier Transform can be considered as an extension of the Fourier Series for aperiodic signals. The Laplace Transform can be considered as an extension of the Fourier Transform to the complex plane.

6.1.1 Unilateral Laplace Transform

The *Laplace Transform*³ of a function $f(t)$, defined for all real numbers $t \geq 0$, is the function $F(s)$, defined by:

$$F(s) = \mathcal{L}\{f(t)\} = \int_0^{\infty} e^{-st} f(t) dt.$$

The parameter s is the complex number:

$$s = \sigma + j\omega, \text{ with a real part } \sigma \text{ and an imaginary part } \omega.$$

6.1.2 Bilateral Laplace Transform

The *Bilateral Laplace Transform* is defined as follows:

$$F(s) = \mathcal{L}\{f(t)\} = \int_{-\infty}^{\infty} e^{-st} f(t) dt.$$

Comparing this definition to the one of the Fourier Transform⁴, one sees that the latter is a special case of the Laplace Transform for $s = j\omega$. In the field of electrical engineering, the Bilateral Laplace Transform is simply referred as the Laplace Transform.

6.1.3 Inverse Laplace Transform

The *Inverse Laplace Transform* allows to find the original time function on which a Laplace Transform has been made.:

$$f(t) = \mathcal{L}^{-1}\{F(s)\} = \frac{1}{2\pi i} \lim_{T \rightarrow \infty} \int_{\gamma - iT}^{\gamma + iT} e^{st} F(s) ds,$$

1 http://en.wikibooks.org/wiki/Signals_and_Systems/Fourier_Series

2 http://en.wikibooks.org/wiki/Signals_and_Systems/Aperiodic_Signals#Fourier_Transform

3 http://en.wikipedia.org/wiki/Laplace_transform

4 http://en.wikibooks.org/wiki/Signals_and_Systems/Aperiodic_Signals#Fourier_Transform

6.2 Differential Equations

6.2.1 Integral and Derivative

The properties of the Laplace transform⁵ show that:

- the transform of a derivative corresponds to a multiplication with s
- the transform of an integral corresponds to a division with s

This is summarized in the following table:

Time Domain	Laplace Domain
$x(t)$	$X(s) = \mathcal{L}\{x(t)\}$
$\dot{x}(t)$	$s \cdot X(s)$
$\int x(t)dt$	$\frac{1}{s} \cdot X(s)$

With this, a set of differential equations is transformed into a set of linear equations which can be solved with the usual techniques of linear algebra.

6.2.2 Lumped Element Circuits

Lumped elements circuits typically show this kind of integral or differential relations between current and voltage:

$$U_C = \frac{1}{sC} \cdot I_C$$

$$U_L = sL \cdot I_L$$

This is why the analysis of a lumped elements circuit is usually done with the help of the Laplace transform.

6.3 Example

6.3.1 Sallen-Key Lowpass Filter



⁵ http://en.wikibooks.org/wiki/Signals_and_Systems/Table_of_Laplace_Transforms#Laplace_Transform_Properties

The Sallen-Key⁶ circuit is widely used for the implementation of analog second order sections.

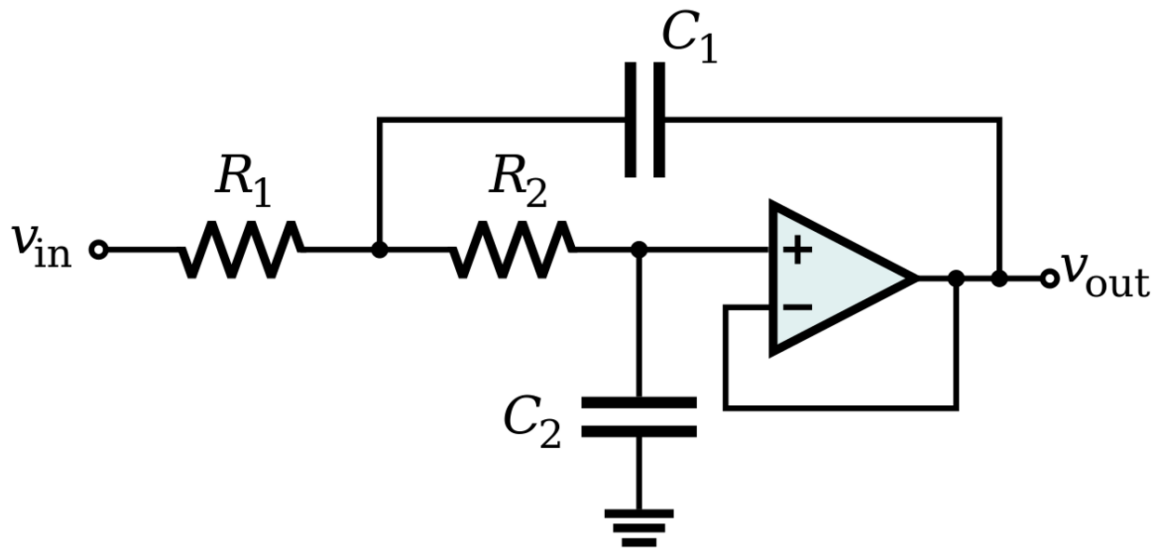

Figure 30 Sallen–Key unity-gain lowpass filter

The image on the side shows the circuit for an all-pole second order function. Writing v_1 the potential between both resistances and v_2 the input of the op-amp follower circuit, gives the following relations:

$$\begin{cases} R_1 I_{R1} = V_{in} - V_1 \\ R_2 I_{R2} = V_1 - V_2 \\ I_{C2} = sC_2 V_2 \\ I_{C1} = sC_1 (V_1 - V_{out}) \\ I_{R1} = I_{R2} + I_{C1} \\ I_{R2} = I_{C2} \\ V_2 = V_{out} \end{cases}$$

Rewriting the current node relations gives:

$$\begin{cases} R_1 R_2 I_{R1} = R_1 R_2 I_{R2} + R_1 R_2 I_{C1} \\ R_2 I_{R2} = R_2 I_{C2} \end{cases}$$

$$\begin{cases} R_2 (V_{in} - V_1) = R_1 (V_1 - V_{out}) + R_1 R_2 s C_1 (V_1 - V_{out}) \\ V_1 - V_{out} = R_2 s C_2 V_{out} \end{cases}$$

$$\begin{cases} R_2 V_{in} = (R_1 + R_2 + R_1 R_2 s C_1) V_1 - (R_1 + R_1 R_2 s C_1) V_{out} \\ V_1 = (1 + s R_2 C_2) V_{out} \end{cases}$$

$$R_2 V_{in} = \left[(1 + s R_2 C_2) (R_1 + R_2 + R_1 R_2 s C_1) - R_1 - R_1 R_2 s C_1 \right] V_{out}$$

⁶ http://en.wikipedia.org/wiki/Sallen_Key_filter

$$V_{in} = \left[(1 + sR_2C_2)(R_1/R_2 + 1 + sR_1C_1 - R_1/R_2 - sR_1C_1) \right] V_{out}$$

$$\frac{V_{in}}{V_{out}} = R_1/R_2 + 1 + sR_1C_1 + sR_1C_2 + sR_2C_2 + s^2R_1R_2C_1C_2 - R_1/R_2 - sR_1C_1$$

and finally:

$$\frac{V_{out}}{V_{in}} = \frac{1}{1 + s(R_1 + R_2)C_2 + s^2R_1R_2C_1C_2}$$

Thus, the transfer function is:

$$H(s) = \frac{\frac{1}{R_1R_2C_1C_2}}{s^2 + \frac{R_1 + R_2}{R_1R_2} \frac{1}{C_2} s + \frac{1}{R_1R_2C_1C_2}}$$

7 Random Signals

Signals and Systems¹

7.1 Probability

This book requires that you first read **Probability**².

This section of the Signals and Systems³ book will be talking about probability, random signals, and noise. This book will not, however, attempt to teach the basics of probability, because there are dozens of resources (both on the internet at large, and on Wikipedia mathematics bookshelf) for probability and statistics. This book will assume a basic knowledge of probability, and will work to explain random phenomena in the context of an Electrical Engineering book on signals.

7.2 Random Variable

A random variable is a quantity whose value is not fixed but depends somehow on chance. Typically the value of a random variable may consist of a fixed part and a random component due to uncertainty or disturbance. Other types of random variables takes their values as a result of the outcome of a random experiment. Random variables are usually denoted with a capital letter. For instance, a generic random variable that we will use often is X . The capital letter represents the random variable itself and the corresponding lower-case letter (in this case " x ") will be used to denote the observed value of X . x is one particular value of the process X .

7.3 Mean

The mean or more precise the expected value of a random variable is the central value of the random value, or the average of the observed values in the long run. We denote the mean of a signal x as μ_x . We will discuss the precise definition of the mean in the next chapter.

1 http://en.wikibooks.org/wiki/Signals_and_Systems

2 <http://en.wikibooks.org/wiki/Probability>

3 http://en.wikibooks.org/wiki/Signals_and_Systems

7.4 Standard Deviation

The standard deviation of a signal x , denoted by the symbol σ_x serves as a measure of how much deviation from the mean the signal demonstrates. For instance, if the standard deviation is small, most values of x are close to the mean. If the standard deviation is large, the values are more spread out. The standard deviation is an easy concept to understand, but in practice it's not a quantity that is easy to compute directly, nor is it useful in calculations. However, the standard deviation is related to a more useful quantity, the **variance**.

7.5 Variance

The variance is the square of the standard deviation and is more of theoretical importance. We denote the variance of a signal x as σ_x^2 . We will discuss the variance and how it is calculated in the next chapter.

7.6 Probability Function

The probability function P is the probability that a certain event will occur. It is calculated based on the **probability density function** and **cumulative distribution function**, described below. We can use the P operator in a variety of ways:

$$P[\text{A coin is heads}] = \frac{1}{2}$$

$$P[\text{A dice shows a 3}] = \frac{1}{6}$$

7.7 Probability Density Function

The Probability Density Function (PDF) of a random variable is a description of the distribution of the values of the random variable. By integrating this function over a particular range, we can find the probability that the random variable takes on a value in that interval. The integral of this function over all possible values is 1. We denote the density function of a signal x as f_x . The probability of an event x_i will occur is given as:

$$P[x_i] = f_x(x_i)$$

7.8 Cumulative Distribution Function

The Cumulative Distribution Function (CDF) of a random variable describes the probability of observing a value at or below a certain threshold. A CDF function will be nondecreasing with the properties that the value of the CDF at negative infinity is zero, and the value of the CDF at positive infinity is 1. We denote the CDF of a function with a capital F. The CDF of a signal x will have the subscript F_x . We can say that the probability of an event occurring less than or equal to x_i is defined in terms of the CDF as:

$$P[x \leq x_i] = F_x(x_i)$$

Likewise, we can define the probability that an event occurs that is greater than x_i as:

$$P[x > x_i] = 1 - F_x(x_i)$$

Or, the probability that an event occurs that is greater than or equal to x_i :

$$P[x \geq x_i] = 1 - F_x(x_i) + f_x(x_i)$$

7.8.1 Relation with PDF

The CDF and PDF are related to one another by a simple integral relation:

$$F_x(x) = \int_{-\infty}^x f_x(\tau) d\tau$$

$$f_x(x) = \frac{d}{dx} F_x(x)$$

7.8.2 Terminology

Several book sources refer to the CDF as the "Probability Distribution Function", with the acronym PDF. To avoid the ambiguity of having both the distribution function and the density function with the same acronym (PDF), some books will refer to the density function as "pdf" (lower case) and the distribution function as "PDF" upper case. To avoid this ambiguity, this book will refer to the distribution function as the CDF, and the density function as the PDF.

Signals and Systems⁴

7.9 Expected Value Operator

The Expected value operator is a linear operator that provides a mathematical way to determine a number of different parameters of a random distribution. The downside of course is that the expected value operator is in the form of an integral, which can be difficult to calculate. The expected value operator will be denoted by the symbol:

$$\mathbb{E}[\cdot]$$

For a random variable X with probability density f_x , the expected value is defined as:

$$\mathbb{E}[X] = \int_{-\infty}^{\infty} x f_X(x) dx.$$

provided the integral exists. The **Expectation** of a signal is the result of applying the expected value operator to that signal. The expectation is another word for the mean of a signal:

$$\mu_x = \mathbb{E}[X]$$

⁴ http://en.wikibooks.org/wiki/Signals_and_Systems

7.10 Moments

The expected value of the N -th power of X is called the N -th moment of X or of its distribution:

$$\mathbb{E}[X^N] = \int_{-\infty}^{\infty} x^N f_X(x) dx.$$

Some moments have special names, and each one describes a certain aspect of the distribution.

7.11 Central Moments

Once we know the expected value of a distribution, we know its location. We may consider all other moments relative to this location and calculate the N^{th} moment of the random variable $X - \mathbb{E}[X]$; the result is called the N^{th} **central moment** of the distribution. Each central moment has a different meaning, and describes a different facet of the random distribution. The N -th central moment of X is:

$$\mathbb{E}[(X - \mathbb{E}[X])^N] = \int_{-\infty}^{\infty} (x - \mathbb{E}[X])^N f_X(x) dx.$$

For sake of simplicity in the notation, the first moment, the expected value is named:

$$\mathbb{E}[X] = \mu_X,$$

The formula for the N -th central moment of X becomes then:

$$\mathbb{E}[(X - \mu_X)^N] = \int_{-\infty}^{\infty} (x - \mu_X)^N f_X(x) dx.$$

It is obvious that the first central moment is zero:

$$\mathbb{E}[(X - \mu_X)] = 0$$

The second central moment is the variance,

$$\mathbb{E}[(X - \mu_X)^2] = \sigma^2$$

7.11.1 Variance

The variance, the second central moment, is denoted using the symbol σ_x^2 , and is defined as:

$$\sigma_x^2 = \text{var}(X) = \mathbb{E}[X - \mathbb{E}[X]]^2 = \mathbb{E}[X^2] - \mathbb{E}[X]^2$$

7.11.2 Standard Deviation

The standard deviation of a random distribution is the square root of the variance, and is given as such:

$$\sigma_x = \sqrt{\sigma_x^2}$$

7.12 Moment Generating Functions

7.13 Time-Average Operator

The time-average operator provides a mathematical way to determine the average value of a function over a given time range. The time average operator can provide the mean value of a given signal, but most importantly it can be used to find the average value of a small sample of a given signal. The operator also allows us a useful shorthand way for taking the average, which is used in many equations. The time average operator is denoted by angle brackets (\langle and \rangle) and is defined as such:

$$\langle f(t) \rangle = \frac{1}{T} \int_0^T f(t) dt$$

Signals and Systems⁵

There are a number of different random distributions in existence, many of which have been studied quite extensively, and many of which map very well to natural phenomena. This book will attempt to cover some of the most basic and most common distributions. This chapter will also introduce the idea of a distribution transformation, which can be used to turn a simple distribution into a more exotic distribution.

7.14 Uniform Distribution

One of the most simple distributions is a Uniform Distribution. Uniform Distributions are also very easy to model on a computer, and then they can be converted to other distribution types by a series of transforms. A uniform distribution has a PDF that is a rectangle. This rectangle is centered about the mean, $\langle \mu_x \rangle$, has a width of A , and a height of $1/A$. This definition ensures that the total area under the PDF is 1.

7.15 Gaussian Distribution

This operation can be performed using this MATLAB⁶ command:

randn

The Gaussian (or normal) distribution is simultaneously one of the most common distributions, and also one of the most difficult distributions to work with. The problem with the Gaussian distribution is that its pdf equation is *non-integratable*, and therefore there is no way to find a general equation for the cdf (although some approximations are available), and there is little or no way to directly calculate certain probabilities. However, there are ways to approximate these probabilities from the Gaussian pdf, and many of the common results have been tabulated in table-format. The function that finds the area under a part

⁵ http://en.wikibooks.org/wiki/Signals_and_Systems

⁶ http://en.wikibooks.org/wiki/MATLAB_Programming

of the Gaussian curve (and therefore the probability of an event under that portion of the curve) is known as the Q function, and the results are tabulated in a Q table.

7.15.1 PDF and CDF

The PDF of a Gaussian random variable is defined as such:

$$f(x) = \frac{1}{\sqrt{2\pi\sigma^2}} e^{-\frac{(x-\mu)^2}{2\sigma^2}}$$

The CDF of the Gaussian function is the integral of this, which any mathematician will tell you is impossible to express in terms of regular functions.

7.15.2 The Functions Φ and Q

The normal distribution with parameters $\mu = 0$ and $\sigma = 1$, the so-called standard normal distribution, plays an important role, because all other normal distributions may be derived from it. The CDF of the standard normal distribution is often indicated by Φ :

$$\Phi(x) = \frac{1}{\sqrt{2\pi}} \int_{-\infty}^x e^{-\frac{t^2}{2}} dt.$$

It gives the probability for a standard normal distributed random variable to attain values less than x. The Q function is the area under the right tail of the Gaussian curve and hence nothing more than $1 - \Phi$. The Q function is hence defined as:

$$Q(x) = 1 - \Phi(x) = \frac{1}{\sqrt{2\pi}} \int_x^{\infty} e^{-\frac{t^2}{2}} dt$$

Mathematical texts might prefer to use the erf(x) and erfc(x) functions, which are similar. However this book (and engineering texts in general) will utilize the Q and Phi functions.

7.16 Poisson Distribution

The Poisson Distribution is different from the Gaussian and uniform distributions in that the Poisson Distribution only describes discrete data sets. For instance, if we wanted to model the number of telephone calls that are traveling through a given switch at one time, we cannot possibly count fractions of a phone call; phone calls come only in integer numbers. Also, you can't have a negative number of phone calls. It turns out that such situations can be easily modeled by a Poisson Distribution. Some general examples of Poisson Distribution random events are:

1. The telephone calls arriving at a switch
2. The internet data packets traveling through a given network
3. The number of cars traveling through a given intersection

7.17 Transformations

If we have a random variable that follows a particular distribution, we would frequently like to transform that random process to use a different distribution. For instance, if we write a computer program that generates a uniform distribution of random numbers, and we would like to write one that generates a Gaussian distribution instead, we can feed the uniform numbers into a transform, and the output will be random numbers following a Gaussian distribution. Conversely, if we have a random variable in a strange, exotic distribution, and we would like to examine it using some of the easy, tabulated Gaussian distribution tools, we can transform it.

7.18 Further Reading

- [Statistics/Distributions](#)⁷
- [Probability/Important Distributions](#)⁸
- [Engineering Analysis/Distributions](#)⁹

[Signals and Systems](#)¹⁰

7.19 Frequency Analysis

Noise, like any other signal, can be analyzed using the Fourier Transform and frequency-domain techniques. Some of the basic techniques used on noise (some of which are particular to random signals) are discussed in this section. Gaussian white noise, one of the most common types of noise used in analysis, has a "flat spectrum". That is, the amplitude of the noise is the same at all frequencies.

7.20 Stationary vs Ergodic Functions

7.21 Power Spectral Density (PSD) of Gaussian White Noise

White noise has a level magnitude spectrum, and if we square it, it will also have a level Power Spectral Density¹¹ (PSD) function. The value of this power magnitude is known by the variable N_0 . We will use this quantity later.

7 <http://en.wikibooks.org/wiki/Statistics/Distributions>

8 http://en.wikibooks.org/wiki/Probability/Important_Distributions

9 http://en.wikibooks.org/wiki/Engineering_Analysis/Distributions

10 http://en.wikibooks.org/wiki/Signals_and_Systems

11 http://en.wikipedia.org/wiki/Power_spectrum

7.22 Wiener Khintchine Einstein Theorem

Using the duality property of the Fourier Transform, the Wiener-Khintchine-Einstein Theorem gives us an easy way to find the PSD for a given signal. If we have a signal $f(t)$, with autocorrelation R_{ff} , then we can find the PSD, S_{xx} by the following function:

$$S_{xx} = \mathcal{F}(R_{ff})$$

Where the previous method for obtaining the PSD was to take the Fourier transform of the signal $f(t)$, and then squaring it.

7.23 Bandwidth

The bandwidth of a random function.

7.23.1 Noise-Equivalent Bandwidth

7.23.2 Band limited Systems

7.23.3 Narrow band Systems

7.24 Windowing

Many random signals are infinite signals, in that they don't have a beginning or an end. To this effect, the only way to really analyze the random signal is take a small chunk of the random signal, called a **sample**. Let us say that we have a long random signal, and we only want to analyze a sample. So we take the part that we want, and destroy the part that we don't want. Effectively, what we have done is to multiply the signal with a rectangular pulse. Therefore, the frequency spectrum of our sampled signal will contain frequency components of the noise *and the rectangular pulse*. It turns out that multiplying a signal by a rectangular pulse is rarely the best way to sample a random signal. It also turns out that there are a number of other **windows** that can be used instead, to get a good sample of noise, while at the same time introducing very few extraneous frequency components. Remember duality? multiplication in the time domain (multiplying by your windowing function) becomes *convolution in the frequency domain*. Effectively, we've taken a very simple problem (getting a sample of information), and created a very difficult problem, the deconvolution of the resultant frequency spectrum. There are a number of different windows that we can use.

7.24.1 Rectangular Window

7.24.2 Triangular Window

7.24.3 Hamming Window

8 Introduction to Filters

Signals and Systems¹

8.1 Frequency Response

Systems respond differently to inputs of different frequencies. Some systems may amplify components of certain frequencies, and attenuate components of other frequencies. The way that the system output is related to the system input for different frequencies is called the *frequency response* of the system. The frequency response is the relationship between the system input and output in the Fourier Domain.

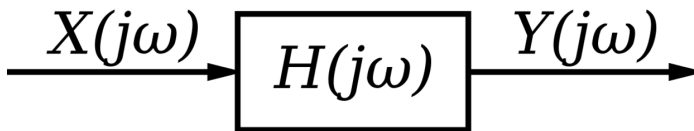

Figure 31

In this system, $X(j\omega)$ is the system input, $Y(j\omega)$ is the system output, and $H(j\omega)$ is the frequency response. We can define the relationship between these functions as:

$$Y(j\omega) = H(j\omega)X(j\omega)$$

$$\frac{Y(j\omega)}{X(j\omega)} = H(j\omega)$$

8.2 The Frequency Response Functions

Since the frequency response is a complex function, we can convert it to polar notation in the complex plane. This will give us a magnitude and an angle. We call the angle the *phase*.

8.2.1 Amplitude Response

For each frequency, the magnitude represents the system's tendency to amplify or attenuate the input signal.

¹ http://en.wikibooks.org/wiki/Signals_and_Systems

$$A(\omega) = |H(j\omega)|$$

8.2.2 Phase Response

The phase represents the system's tendency to modify the phase of the input sinusoids.

$$\phi(\omega) = \angle H(j\omega).$$

The phase response, or its derivative the group delay, tells us how the system delays the input signal as a function of frequency.

8.3 Examples

8.3.1 Example: Electric Circuit

Consider the following general circuit with phasor input and output voltages:

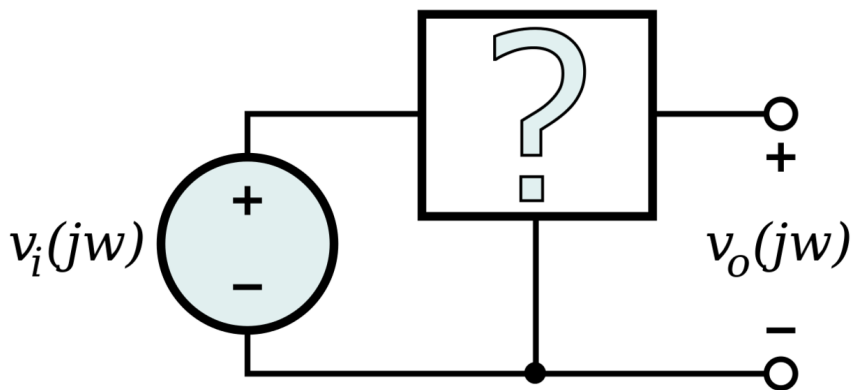

Figure 32

Where

$$V_o(j\omega) = V_{om} \cos(\omega t + \theta_o) = V_{om} \angle \theta_o$$

$$V_i(j\omega) = V_{im} \cos(\omega t + \theta_i) = V_{im} \angle \theta_i$$

As before, we can define the system function, $H(j\omega)$ of this circuit as:

$$H(j\omega) = \frac{V_o(j\omega)}{V_i(j\omega)}$$

$$A(\omega) = |H(j\omega)| = \frac{|V_o(j\omega)|}{|V_i(j\omega)|} = \frac{V_{om}}{V_{im}}$$

$$\phi(\omega) = \angle H(j\omega) = \angle \left(\frac{V_o(j\omega)}{V_i(j\omega)} \right) = \angle V_o(j\omega) - \angle V_i(j\omega) = \theta_o - \theta_i$$

Rearranging gives us the following transformations:

$$V_{om} = A(\omega) V_{im}$$

$$\theta_o = \theta_i + \phi(\omega)$$

8.3.2 Example: Low-Pass Filter

We will illustrate this method using a simple low-pass filter with general values as an example. This kind of circuit allows low frequencies to pass, but blocks higher ones. Find the frequency response function, and hence the amplitude and phase response functions, of the following RC circuit (it is already in phasor form):

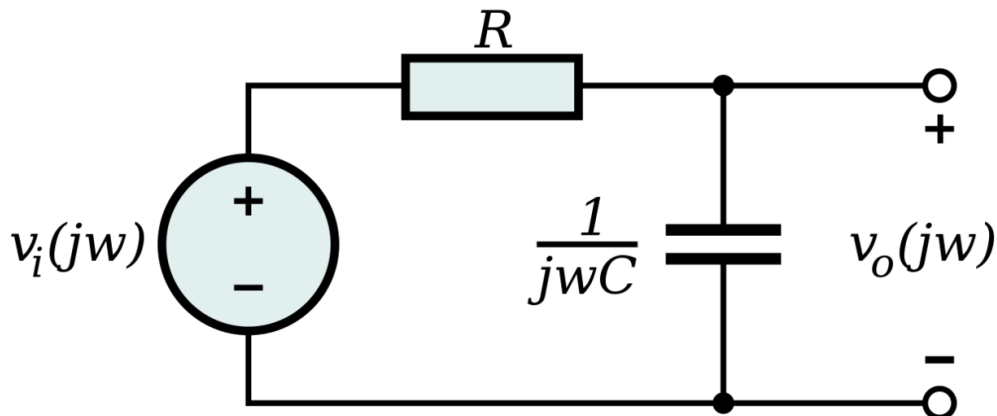

Figure 33

Firstly, we use the voltage divider rule to get the output phasor in terms on the input phasor:

$$V_o(j\omega) = V_i(j\omega) \cdot \frac{\frac{1}{j\omega C}}{R + \frac{1}{j\omega C}}$$

Now we can easily determine the frequency response:

$$H(j\omega) = \frac{V_o(j\omega)}{V_i(j\omega)} = \frac{\frac{1}{j\omega C}}{R + \frac{1}{j\omega C}}$$

This simplifies down to:

$$H(j\omega) = \frac{1}{1 + j\omega RC}$$

From here we can find the amplitude and phase responses:

$$A(\omega) = |H(j\omega)| = \frac{1}{\sqrt{1+(\omega CR)^2}}$$

$$\phi(\omega) = \angle H(j\omega) = \tan^{-1}\left(\frac{0}{1}\right) - \tan^{-1}\left(\frac{\omega RC}{1}\right) = -\tan^{-1}(\omega RC)$$

The frequency response is pictured by the plots of the amplitude and phase responses:

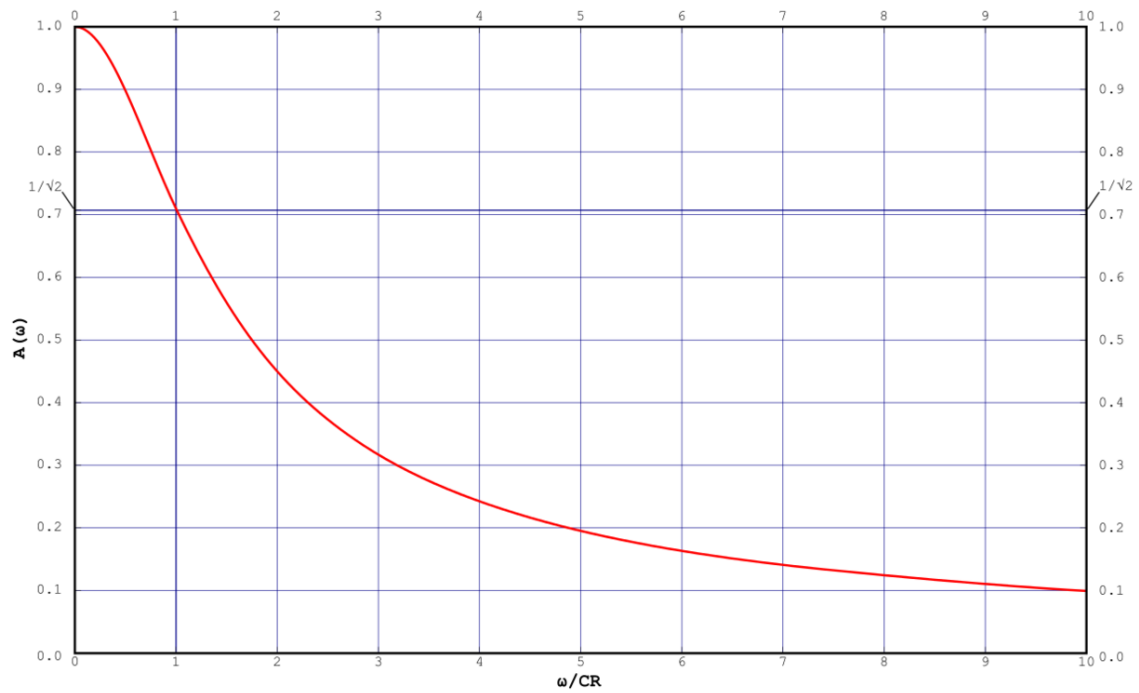

Figure 34

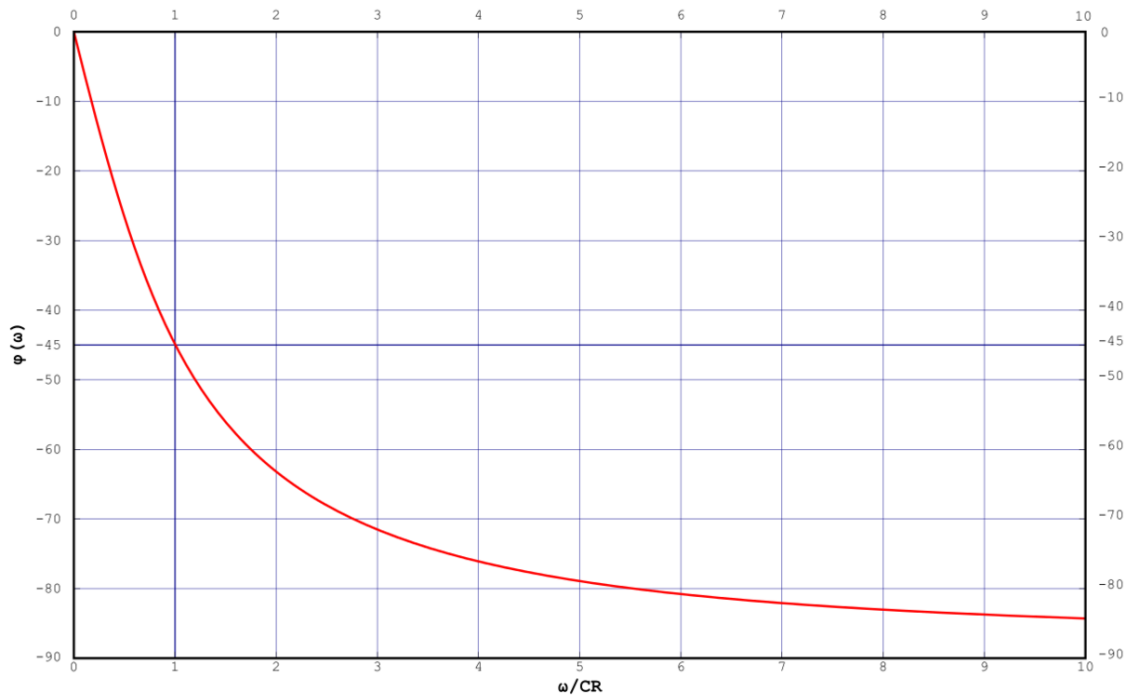

Figure 35

It is often easier to interpret the graphs when they are plotted on suitable logarithmic scales:

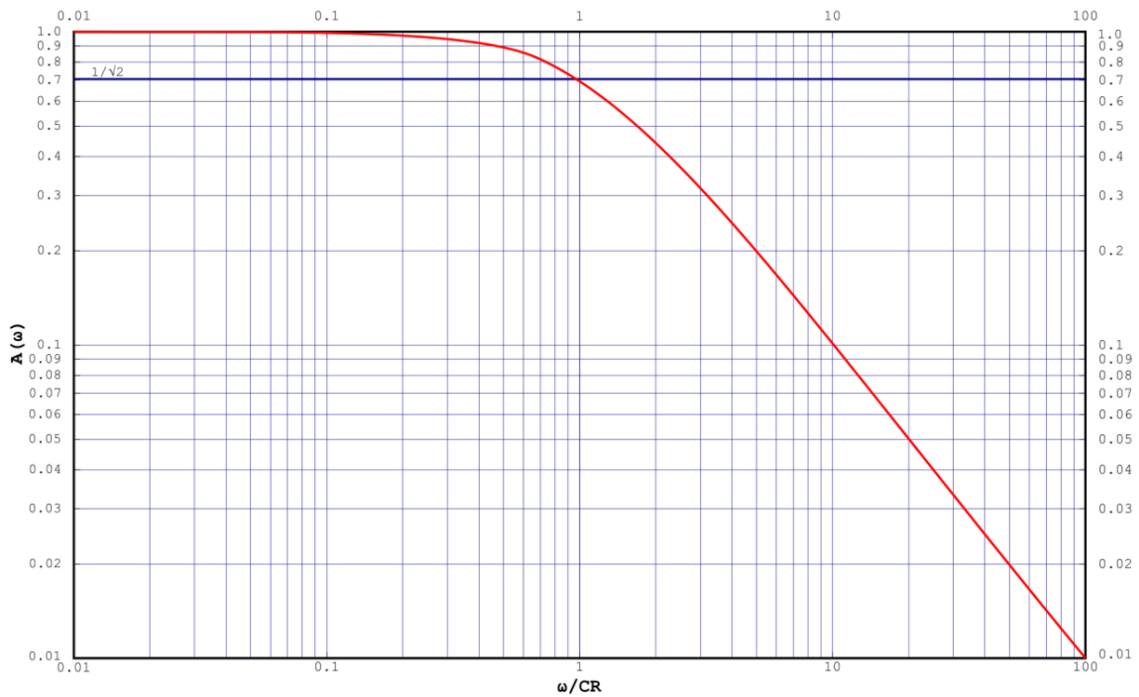

Figure 36

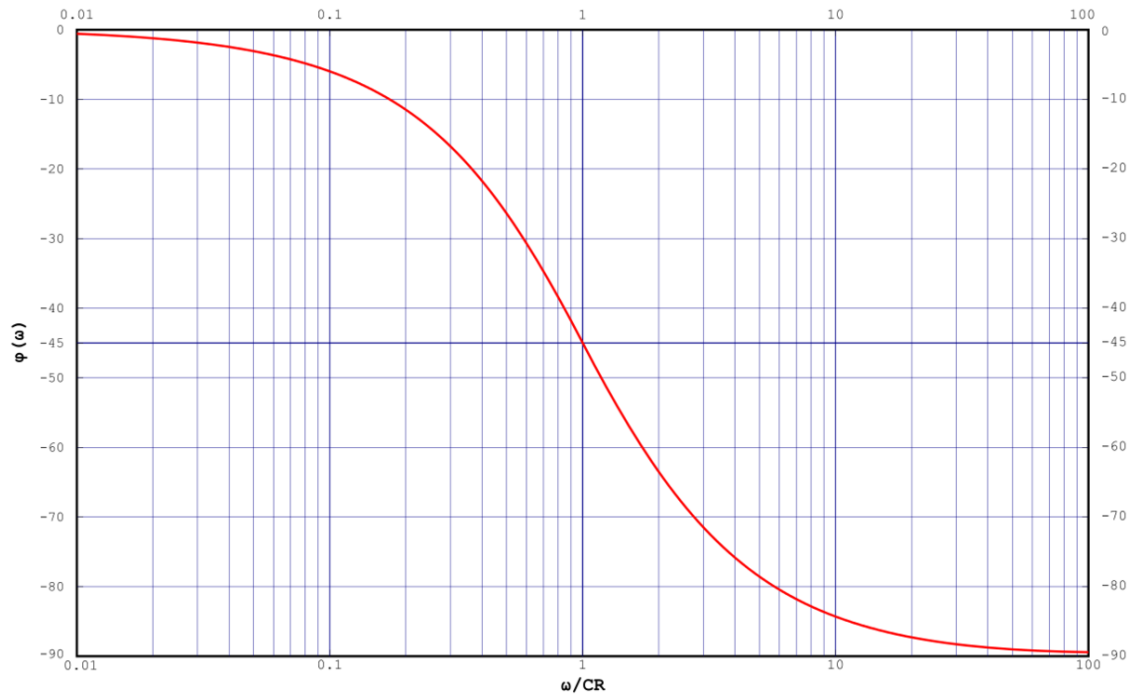

Figure 37

This shows that the circuit is indeed a filter that removes higher frequencies. Such a filter is called a *lowpass filter*. The amplitude and phase responses of an arbitrary circuit can be plotted using an instrument called a **spectrum analyser** or **gain and phase test set**. See Practical Electronics² for more details on using these instruments.

8.4 Filters

An important concept to take away from these examples is that by designing a proper system called a **filter**, we can selectively attenuate or amplify certain frequency ranges. This means that we can minimize certain unwanted frequency components (such as noise or competing data signals), and maximize our own data signal. We can define a "received signal" r as a combination of a data signal d and unwanted components v :

$$r(t) = d(t) + v(t)$$

We can take the energy spectral density of r to determine the frequency ranges of our data signal d . We can design a filter that will attempt to amplify these frequency ranges, and attenuate the frequency ranges of v . We will discuss this problem and filters in general in the next few chapters. More advanced discussions of this topic will be in the book on Signal Processing³.

² http://en.wikibooks.org/wiki/Practical_Electronics

³ http://en.wikibooks.org/wiki/Signal_Processing

Signals and Systems⁴

8.5 Terminology

When it comes to filters, there is a large amount of terminology that we need to discuss first, so the rest of the chapters in this section will make sense.

Order (Filter Order)

The order of a filter is an integer number, that defines how complex the filter is. In common filters, the order of the filter is the number of "stages" of the filter. Higher order filters perform better, but they have a higher delay, and they cost more.

Pass Band

In a general sense, the passband is the frequency range of the filter that allows information to pass. The passband is usually defined in the specifications of the filter. For instance, we could define that we want our passband to extend from 0 to 1000 Hz, and we want the amplitude in the entire passband to be higher than -1 db.

Transition Band

The transition band is the area of the filter between the passband and the stopband. Higher-order filters have a thinner transition band

Stop Band

The stop band of a filter is the frequency range where the signal is attenuated. Stop band performance is often defined in the specification for the filter. For instance, we might say that we want to attenuate all frequencies above 5000 Hz, and we want to attenuate them all by -40 db or more

Cut-off Frequency

The cut-off frequency of a filter is the frequency at which the filter "breaks", and changes (between pass band and transition band, or transition band and passband, for instance). The cut-off of a filter *always has an attenuation of -3db*. The -3 db point is the frequency that is cut in power by exactly 1/2.

8.6 Lowpass

Lowpass filters allow low frequency components to pass through, while attenuating high frequency components. Lowpass filters are some of the most important and most common filters, and much of our analysis is going to be focused on them. Also, transformations exist that can be used to convert the mathematical model of a lowpass filter into a model of a highpass, bandpass, or bandstop filter. This means that we typically design lowpass filters and then transform them into the appropriate type.

⁴ http://en.wikibooks.org/wiki/Signals_and_Systems

8.6.1 Example: Telephone System

As an example of a lowpass filter, consider a typical telephone line. Telephone signals are **bandlimited**, which means that a filter is used to prevent certain frequency components from passing through the telephone network. Typically, the range for a phone conversation is 10Hz to 3'000Hz. This means that the phone line will typically incorporate a lowpass filter that attenuates all frequency components above 3'000Hz. This range has been chosen because it includes all the information humans need for clearly understanding one another, so the effects of this filtering are not damaging to a conversation. Comparatively, CD recordings comprise most of the human hearing and their frequency components range up to 20'000Hz or 20kHz.

8.7 Highpass

Highpass filters allow high frequency components to pass through, while attenuating low frequency components.

8.7.1 Example: DSL Modems

Consider DSL modems, which are high-speed data communication devices that transmit over the existing telephone network. DSL signals operate in the high frequency ranges, above the 3000Hz limit for voice conversations. In order to separate the DSL data signal from the regular voice signal, the signal must be sent into two different filters: a lowpass filter to amplify the voice for the telephone signal, and a highpass filter to amplify the DSL data signal.

8.8 Bandpass

A bandpass filter allows a single band of frequency information to pass the filter, but will attenuate all frequencies above the band and below the band. A good example of a bandpass filter is an FM radio tuner. In order to focus on one radio station, a filter must be used to attenuate the stations at both higher and lower frequencies.

8.9 Bandstop

A bandstop filter will allow high frequencies and low frequencies to pass through the filter, but will attenuate all frequencies that lay within a certain band.

8.10 Gain/Delay equalizers

Filters that cannot be classified into one of the above categories, are called gain or delay equalizers. They are mainly used to equalize the gain/phase in certain parts of the frequency

spectrum as needed. More discussion on these kinds of advanced topics will be in Signal Processing⁵.

Signals and Systems⁶

Filter design mostly bases on a limited set of widely used transfer functions. Optimization methods allow to design other types of filters, but the functions listed here have been studied extensively, and designs for these filters (including circuit designs to implement them) are readily available. The filter functions presented here⁷ are of lowpass type, and transformation methods⁸ allow to obtain other common filter types such as highpass, bandpass or bandstop.

8.11 Butterworth Filters

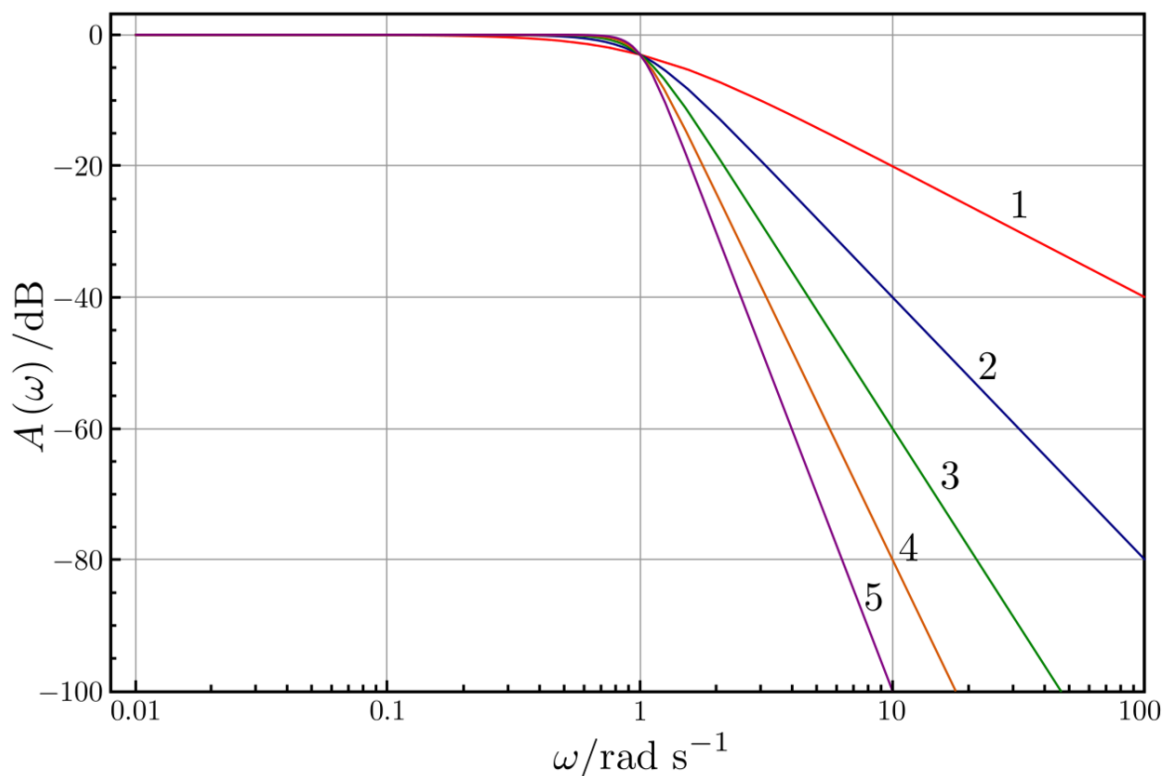

Figure 38 Plot of the amplitude response of the normalized Butterworth lowpass transfer function, for orders 1 to 5

⁵ http://en.wikibooks.org/wiki/Signal_Processing

⁶ http://en.wikibooks.org/wiki/Signals_and_Systems

⁷ #Comparison

⁸ http://en.wikibooks.org/wiki/Signals_and_Systems/Filter_Transforms

The Butterworth filter function⁹ has been designed to provide a maximally flat amplitude response. This is obtained by the fact that all the derivatives up to the filter order minus one are zero at DC. The amplitude response has no ripple in the passband. It is given by:

$$A(j\omega) = |H(j\omega)| = \sqrt{\frac{1}{1+\omega^{2n}}}$$

It should be noted that whilst the amplitude response is very smooth, the step response shows noticeable overshoots. They are due to the phase response which is not linear or, in other words, to the group delay which is not constant. The amplitude response plot shows that the slope is $20n$ dB/decade, where n is the filter order. This is the general case for all-pole lowpass filters. Zeros in the transfer function can accentuate the slope close to their frequency, thus masking this general rule for zero-pole lowpass filters. The plot also shows that whatever the order of the filter, all the amplitudes cross the same point at $A(\omega = 1) = \frac{1}{\sqrt{2}}$, which corresponds to approximately -3 db. This -3 db reference is often used to specify the cutoff frequency of other kinds of filters. Butterworth filters don't have a particularly steep drop-off but, together with Chebyshev type I¹⁰ filters, they are of all-pole kind. This particularity results in reduced hardware (or software, depending on the implementation method), which means that for a similar complexity, higher order Butterworth filters can be implemented, compared to functions with a steeper drop-off such as elliptic filters¹¹.

9 http://en.wikipedia.org/wiki/Butterworth_filter

10 http://en.wikibooks.org/wiki/Signals_and_Systems/Filter_Implementations#Chebyshev_Type_I

11 [#Elliptic_Filters](#)

8.11.1 Zeroes of the Butterworth function

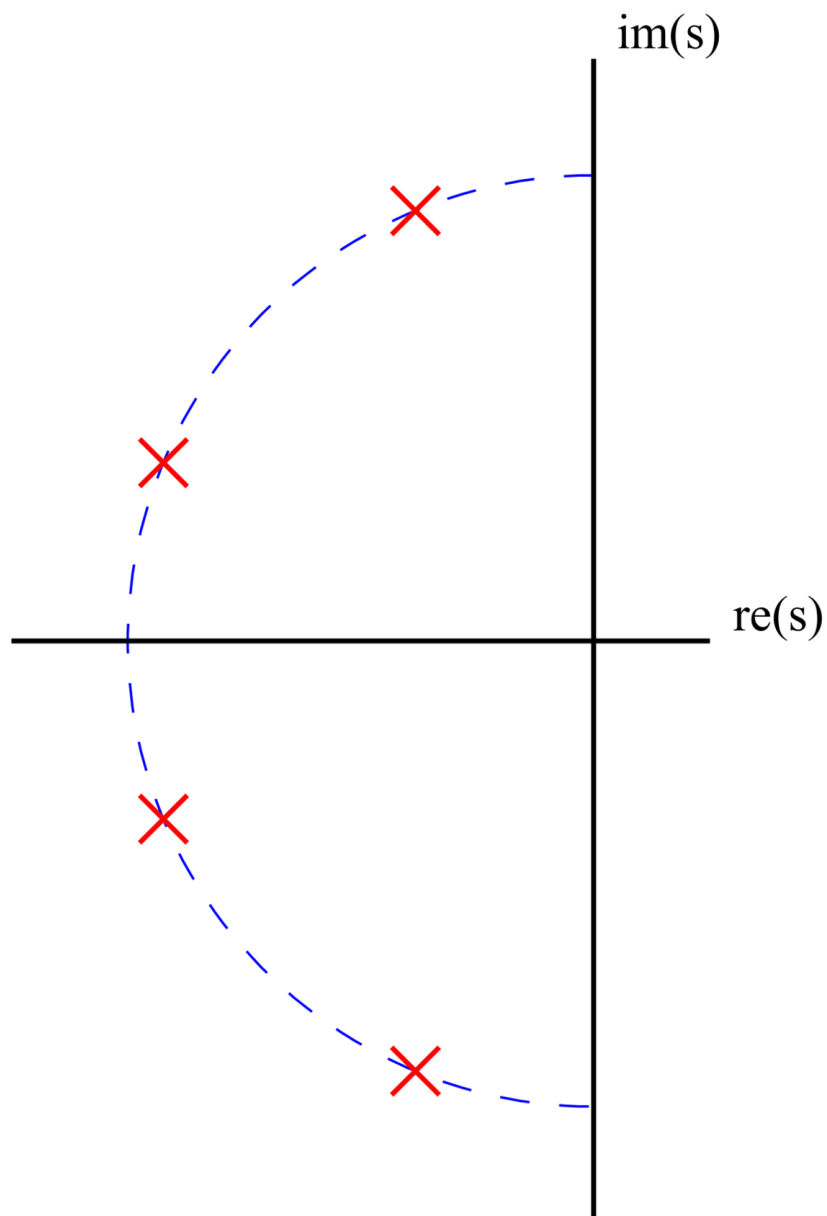

Figure 39 Poles of a 4th order Butterworth filter

The normalized Butterworth function is indirectly defined by:

$$H(s) \cdot H(-s) = \frac{1}{1+\omega^{2n}}$$

This function has zeroes regularly placed on the unit circle. Knowing that a stable filter has all of its poles on the left half s-plane, it is clear that the left half poles on the unit circle belong to $H(s)$, whilst the right half poles on the right belong to $H(-s)$. The normalized

Butterworth function has a cutoff frequency at $f_c = \omega_c/(2\pi) = 1/(2\pi)[Hz]$. A different cutoff frequency is achieved by scaling¹² the circle radius to $\omega_c = 2\pi f_c$.

8.11.2 Butterworth Transfer Function

The transfer function of a Butterworth filter is of the form:

$$H(s) = \frac{1}{den(s)}$$

It can also be written as a function of the poles:

$$H(s) = \frac{k}{\prod_{i=1}^N (s-p_i)}$$

With this, the denominator ploynom is found from the values of the poles.

8.12 Chebyshev Filters

In comparison to Butterworth filters, Chebyshev filters¹³ have a supplemental parameter: a ripple in amplitude. This ripple, wich could be considered as non ideal, has the tremendous advantage to allow a steeper roll-off between passband and stopband. The ripple can happen in the passband, which is the case for Type I Chebyshev filters, or in the stopband for Type II filters.

¹² http://en.wikibooks.org/wiki/Signals_and_Systems/Filter_Transforms#Lowpass_to_Lowpass

¹³ http://en.wikipedia.org/wiki/Chebyshev_filter

8.12.1 Chebyshev Polynomials

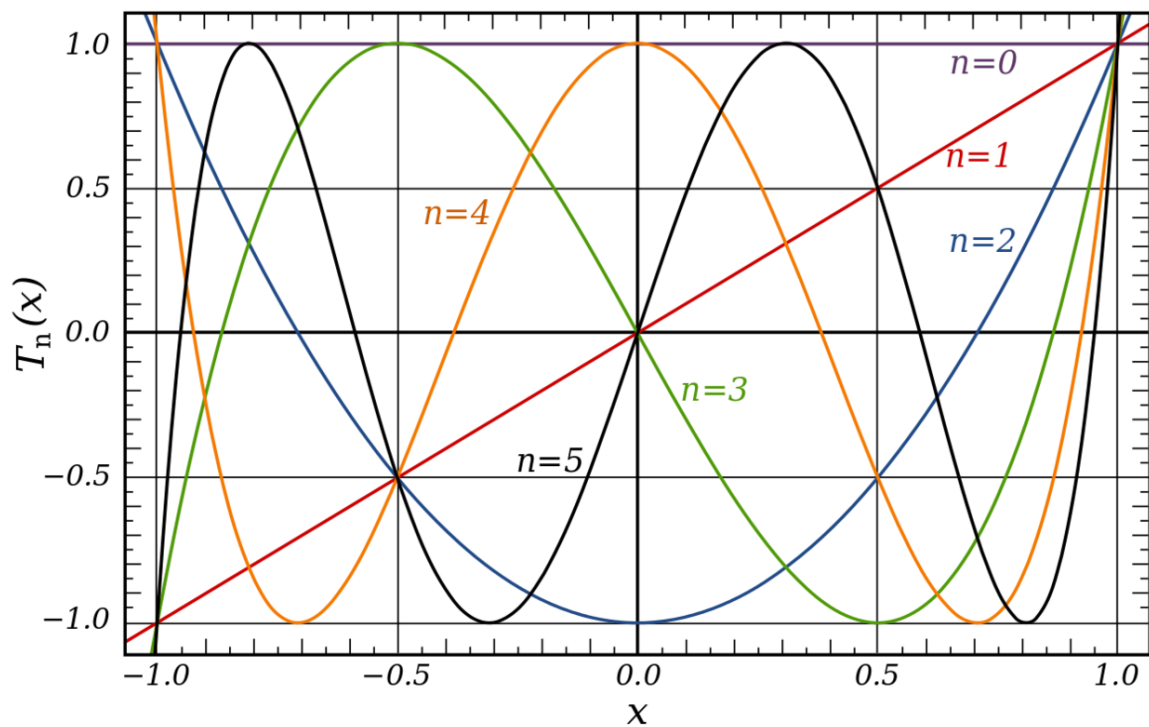

Figure 40 Chebyshev polynomials in the domain $-1 < x < 1$

Chebyshev Polynomials¹⁴ have the property to remain in the range $-1 < T_n(x) < 1$ for an input in the range $-1 < x < 1$ and then rapidly grow outside this range. This characteristic is a good prerequisite for devising transfer functions with limited oscillations in a given frequency range and steep roll-offs at its borders. The Chebyshev polynomials of the first kind are defined by the recurrence relation:

$$T_0(x) = 1$$

$$T_1(x) = x$$

$$T_{n+1}(x) = 2x \cdot T_n(x) - T_{n-1}(x).$$

The first Chebyshev polynomials of the first kind are:

$$T_0(x) = 1$$

$$T_1(x) = x$$

$$T_2(x) = 2x^2 - 1$$

$$T_3(x) = 4x^3 - 3x$$

$$T_4(x) = 8x^4 - 8x^2 + 1$$

14 http://en.wikipedia.org/wiki/Chebyshev_polynomials

8.12.2 Chebyshev Type I

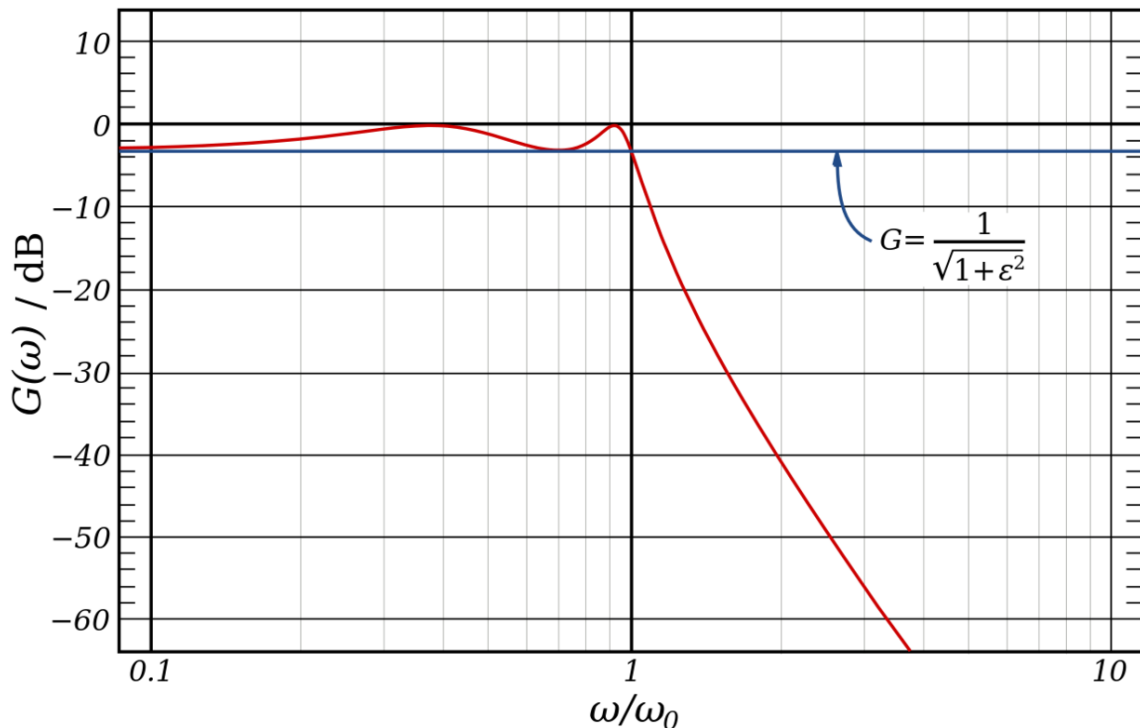

Figure 41 Frequency response of a fourth-order type I Chebyshev filter

Chebyshev type I filters show a ripple in the passband. The amplitude response¹⁵ as a function of angular frequency ω of the n th-order low-pass filter is:

$$G_n(\omega) = |H_n(j\omega)| = \frac{1}{\sqrt{1 + \varepsilon^2 T_n^2\left(\frac{\omega}{\omega_0}\right)}}$$

where ε is the ripple factor, ω_0 is the cutoff frequency¹⁶ and $T_n()$ is a Chebyshev polynomial¹⁷ of order n . The passband exhibits equiripple behavior, with the ripple determined by the ripple factor ε . In the passband, the Chebyshev polynomial alternates between 0 and 1 so the filter gain will alternate between maxima at $G = 1$ and minima at $G = 1/\sqrt{1 + \varepsilon^2}$. At the cutoff frequency ω_0 the gain again has the value $1/\sqrt{1 + \varepsilon^2}$ but continues to drop into the stop band as the frequency increases. This behavior is shown in the diagram on the right. The common practice of defining the cutoff frequency at -3 dB¹⁸ is usually not applied to Chebyshev filters; instead the cutoff is taken as the point at which the gain falls to the value of the ripple for the final time.

15 http://en.wikibooks.org/wiki/Signals_and_Systems/Frequency_Response#Amplitude_Response

16 http://en.wikibooks.org/w/index.php?title=Cutoff_frequency&action=edit&redlink=1

17 http://en.wikibooks.org/wiki/Signals_and_Systems/Filter_Implementations#Chebyshev_Polynomials

18 <http://en.wikibooks.org/w/index.php?title=Decibel&action=edit&redlink=1>

8.12.3 Chebyshev Type II

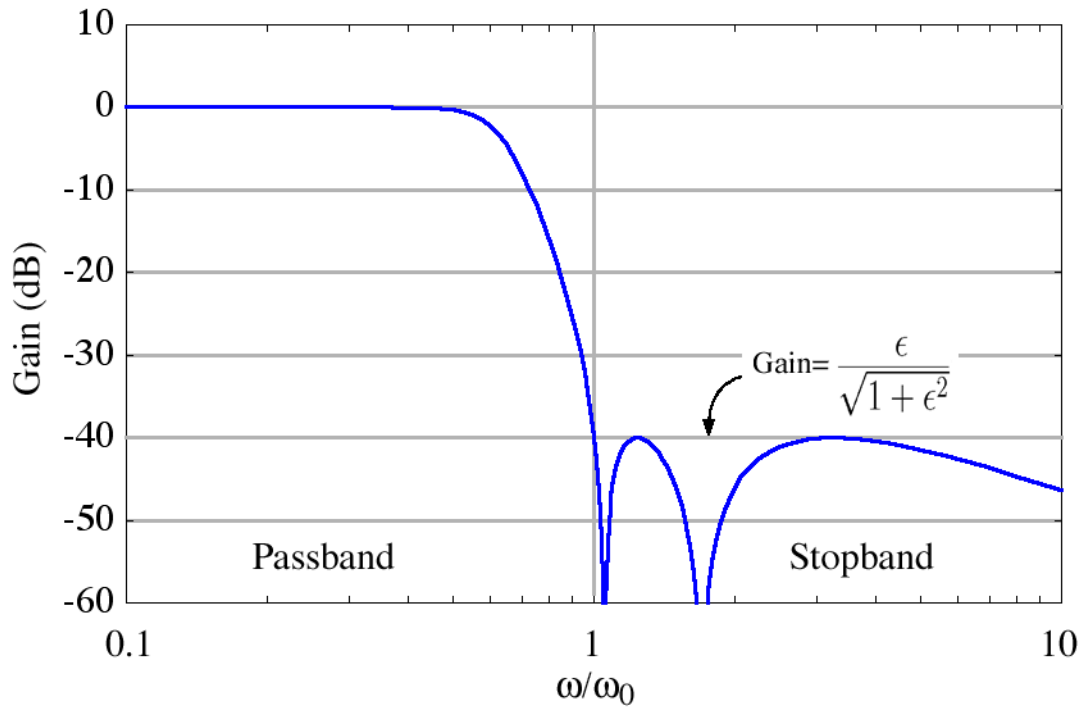

Figure 42 Frequency response of a fifth-order type II Chebyshev filter

Chebyshev Type II filters have ripples in the stopband. The amplitude response is:

$$G_n(\omega, \omega_0) = \frac{1}{\sqrt{1 + \frac{1}{\epsilon^2 T_n^2(\omega_0/\omega)}}}$$

In the stopband, the gain will always be smaller than

$$\frac{1}{\sqrt{1 + \frac{1}{\epsilon^2}}}$$

Also known as inverse Chebyshev, this filter function is less common because it does not roll-off as fast as type I, and requires more components. Indeed, the transfer function exhibits not only poles but also zeroes.

8.13 Elliptic Filters

Elliptic filters¹⁹, also called Cauer filters, suffer from a ripple effect like Chebyshev filters. However, unlike the type 1 and Type 2 Chebyshev filters, Elliptic filters have ripples in both the passband and the stopband. To counteract this limitation, Elliptic filters have a very aggressive rolloff, which often more than makes up for the ripples.

¹⁹ http://en.wikipedia.org/wiki/Cauer_filter

8.14 Comparison

The following image shows a comparison between 5th order Butterworth, Chebyshev and elliptic filter amplitude responses.

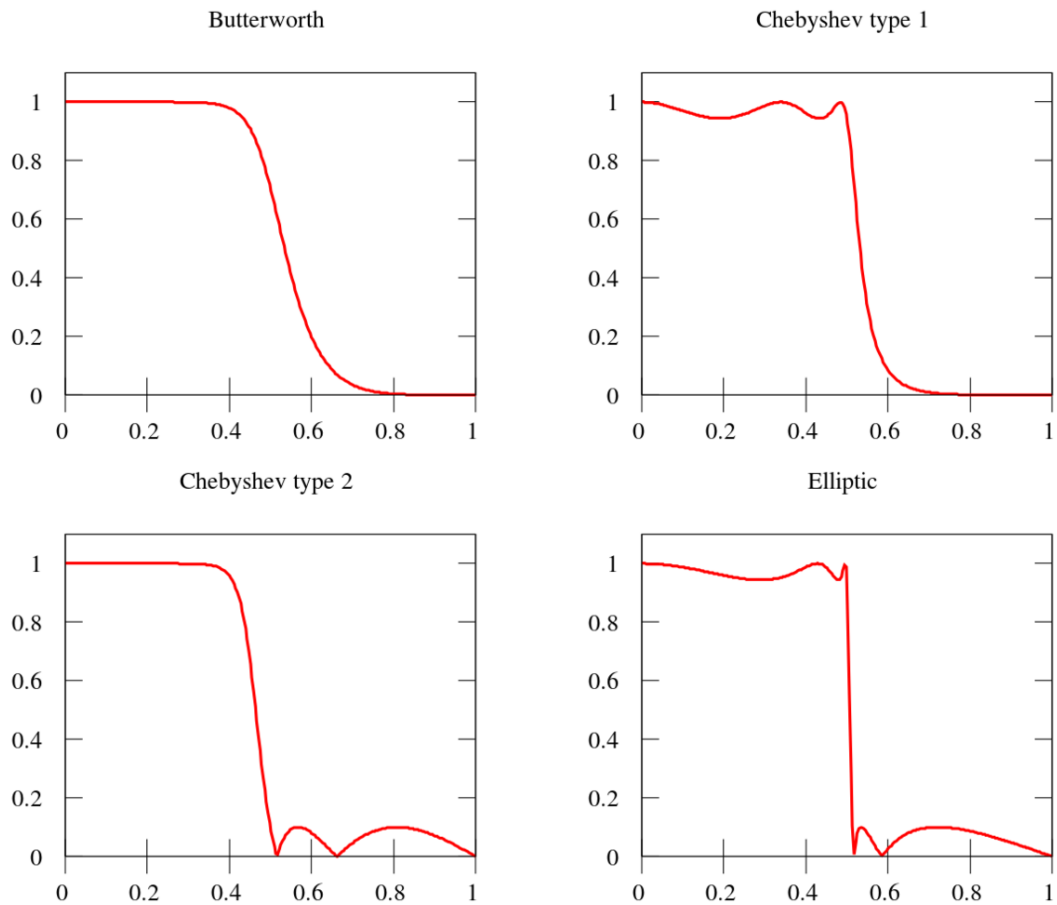

Figure 43

8.15 Bessel Filters

8.16 Filter Design

Using what we've learned so far about filters, this chapter will discuss filter design, and will show how to make decisions as to the type of filter (Butterworth, Chebyshev, Elliptic), and will help to show how to set parameters to achieve a set of specifications.

Signals and Systems²⁰

²⁰ http://en.wikibooks.org/wiki/Signals_and_Systems

8.17 Normalized Lowpass Filter

When designing a filter, it is common practice to first design a normalized low-pass filter, and then use a spectral transform to transform that low-pass filter into a different type of filter (high-pass, band-pass, band-stop). The reason for this is because the necessary values for designing lowpass filters are extensively described and tabulated. From this, filter design can be reduced to the task of looking up the appropriate values in a table, and then transforming the filter to meet the specific needs.

8.18 Lowpass to Lowpass Transformation

Converting a normalized lowpass filter to another lowpass filter allows to set the cutoff frequency of the resulting filter. This is also called frequency scaling²¹.

8.18.1 Transformation

Having a normalized transfer function, with cutoff frequency of 1 Hz, one can modify it in order to move the cutoff frequency to a specified value f_c . This is done with the help of the following replacement:

$$s \rightarrow f_c \cdot s$$

8.18.2 Transfer Function

As an example, the biquadratic transfer function²²

$$H(s) = \frac{Y(s)}{X(s)} = \frac{b_2 s^2 + b_1 s + b_0}{a_2 s^2 + a_1 s + a_0}$$

will be transformed into:

$$H(s) = \frac{Y(s)}{X(s)} = \frac{b_2 f_c^2 s^2 + b_1 f_c s + b_0}{a_2 f_c^2 s^2 + a_1 f_c s + a_0}$$

In the transfer function, all coefficients are multiplied by the corresponding power of f_c .

8.18.3 Analog Element Values

If the filter is given by a circuit and its R, L and C element values found in a table, the transfer function is scaled by changing the element values. The resistance values will stay as they are (a further impedance scaling can be done). The capacitance values are changed according to:

$$\frac{1}{sC} \rightarrow \frac{1}{s f_c \frac{C}{f_c}}$$

²¹ http://en.wikipedia.org/wiki/Prototype_filter#Frequency_scaling

²² http://en.wikibooks.org/wiki/Signals_and_Systems/Second_Order_Transfer_Function#Biquadratic_Second_Order_Transfer_Function

The inductance values are changed according to:

$$sL \rightarrow s f_c \frac{L}{f_c}$$

In the circuit, all capacitances and inductances values are divided by f_c .

8.19 Lowpass to Highpass

This operation can be performed using this MATLAB²³ command:

lp2hp

Converting a lowpass filter to a highpass filter is one of the easiest transformations available. To transform to a highpass, we will replace all S in our equation with the following: $S = \frac{\Omega_p \Omega_p}{\hat{S}}$

8.20 Lowpass to Bandpass

This operation can be performed using this MATLAB²⁴ command:

lp2bp

To Convert from a low-pass filter to a bandpass filter requires that we replace S with the following: $S =$

8.21 Lowpass to Bandstop

This operation can be performed using this MATLAB²⁵ command:

lp2bs

To convert a lowpass filter to a bandstop filter, we replace every reference to S with: $S =$

Signals and Systems²⁶

The Laplace transform²⁷ has shown to allow to analyse the frequency response²⁸ of circuits based on the differential equations of their capacitive and inductive components. Filter design starts with finding the proper transfer function in order to amplify selected parts of a signal and to damp other ones as a function of their frequency. Choosing the proper filter

23 http://en.wikibooks.org/wiki/MATLAB_Programming

24 http://en.wikibooks.org/wiki/MATLAB_Programming

25 http://en.wikibooks.org/wiki/MATLAB_Programming

26 http://en.wikibooks.org/wiki/Signals_and_Systems

27 http://en.wikibooks.org/wiki/Signals_and_Systems/LaPlace_Transform

28 http://en.wikibooks.org/wiki/Signals_and_Systems/Frequency_Response

structure and deriving the coefficient values is a further topic presented in the wikibook *Signal Processing*²⁹ which deals with the application of signal and systems.

8.22 Brick-wall filters

Separating signal from noise or different signals in the same transmission channel basing on their frequency content is best done with a brick-wall filter³⁰ which shows full transmission in the passband and complete attenuation in the nearby stopbands, with abrupt transitions. This can be done with the help of the Fourier transform³¹ which provides complete information of the frequency content of a given signal. Having calculated a Fourier transform, one can zero out unwanted frequency contents and calculate the inverse Fourier Transform³², in order to provide the signal filtered with a brick-wall gauge. The Fourier transform³³ being given by:

$$\mathcal{F}(f(t)) = F(j\omega) = \int_{-\infty}^{\infty} f(t)e^{-j\omega t} dt$$

one finds out that the Fourier transform integral, with its infinite bounds, would have to be calculated from the day of the creation of our universe and all the way up to the day of its decay before the integral could have been fully calculated. And only then can the ideal brick-wall filtered signal be delivered. In more technical terms, the ideal brick-wall filter suffers from an infinite latency.

8.23 Analog filters

The analysis of analog circuits shows that their outputs are related to their input by a set of differential equations. The Laplace transform³⁴ rewrites these differential equations as a set of linear equations of the complex variable s . With this, a polynomial function multiplying the Laplace transform of the input signal can be equated to another polynomial function multiplying the Laplace transform of the output signal:

$$(b_m s^m + b_{m-1} s^{m-1} + \dots + b_1 s + b_0) \cdot X(s) = (a_n s^n + a_{n-1} s^{n-1} + \dots + a_1 s + a_0) \cdot Y(s)$$

Thus, the transfer function of a realizable analog filter can be written as the ratio of two polynomial functions of s :

$$H(s) = \frac{Y(s)}{X(s)} = \frac{b_m s^m + b_{m-1} s^{m-1} + \dots + b_1 s + b_0}{a_n s^n + a_{n-1} s^{n-1} + \dots + a_1 s + a_0}$$

Hence, the problem of analog filter design is to find a pair of polynomial functions which, put together, best approximate the ideal but not realizable brick-wall transfer function. In the early days of electric signal processing, scientists have come up with filter functions³⁵

29 http://en.wikibooks.org/wiki/Signal_Processing/Filter_Design

30 http://en.wikipedia.org/wiki/Sinc_filter#Brick-wall_filters

31 http://en.wikibooks.org/wiki/Signals_and_Systems/Aperiodic_Signals

32 http://en.wikibooks.org/wiki/Signals_and_Systems/Aperiodic_Signals#Inverse_Fourier_Transform

33 http://en.wikibooks.org/wiki/Signals_and_Systems/Aperiodic_Signals#Fourier_Transform

34 http://en.wikibooks.org/wiki/Signals_and_Systems/LaPlace_Transform

35 http://en.wikibooks.org/wiki/Signals_and_Systems/Filter_Implementations

which are still largely used today. The functions they have devised are all of lowpass type. Frequency transformation³⁶ techniques allow to find polynomials for other filter types³⁷ such as highpass and bandpass.

8.24 The Complex Plane

The transfer function of an analog filter is the ratio of two polynomial functions of s :

$$H(s) = \frac{Y(s)}{X(s)} = \frac{num(s)}{den(s)}$$

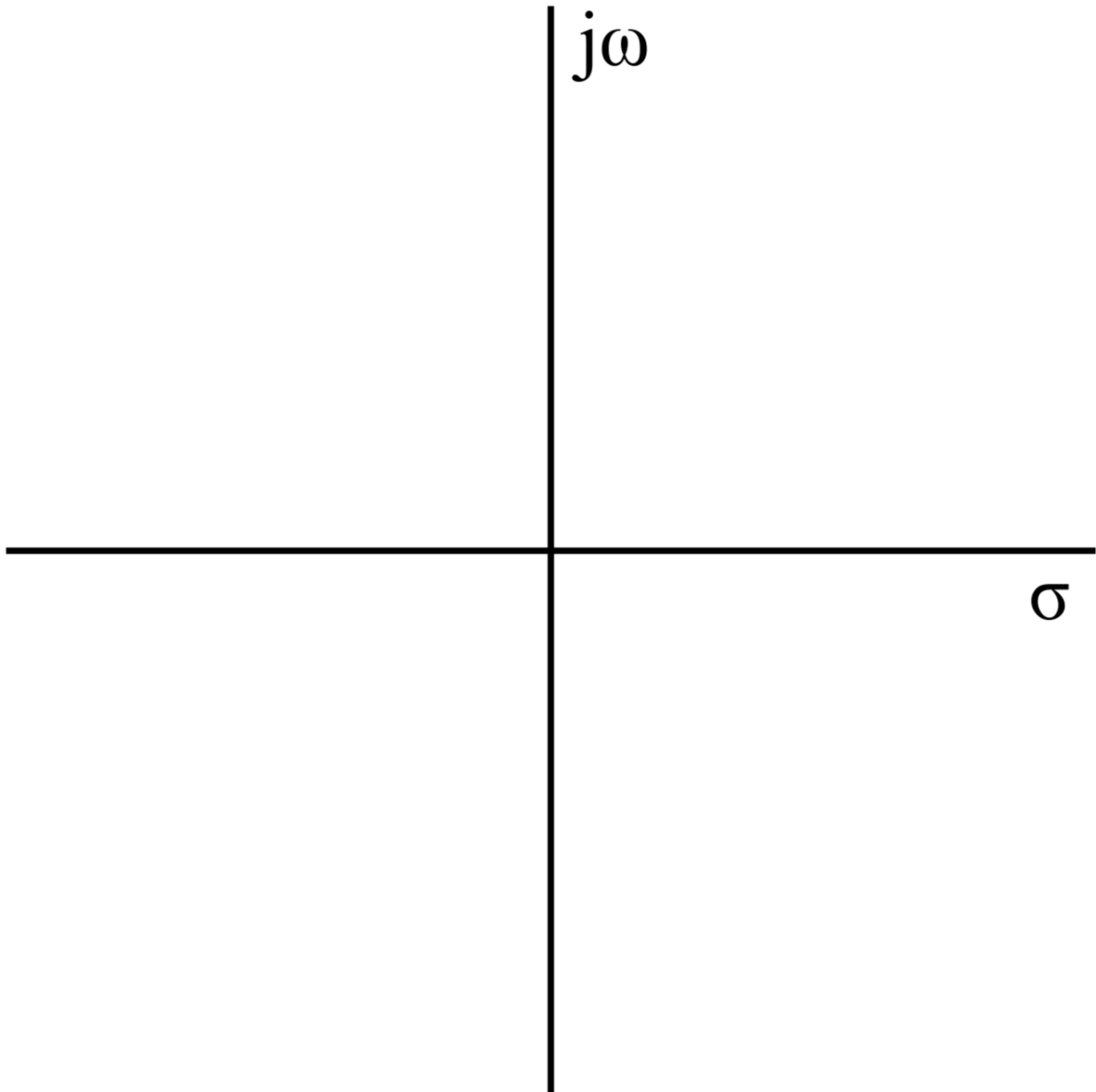

Figure 44 The complex plane of

36 http://en.wikibooks.org/wiki/Signals_and_Systems/Filter_Transforms

37 http://en.wikibooks.org/wiki/Signals_and_Systems/Filter_Terminology

The variable s is a complex number which can be written as $s = \sigma + i \cdot \omega$. The complex plane is a plane with the imaginary axis vertical and the horizontal axis as the real part. The roots of the transfer function numerator polynomial are called the transfer function *zeroes*. The roots of the transfer function denominator polynomial are called the transfer function *poles*. The transfer function can be written as a function of its zeroes z_i , its poles p_i and an additional gain factor k in the form:

$$H(s) = k \cdot \frac{\prod_{i=1}^M (s - z_i)}{\prod_{i=1}^N (s - p_i)}$$

The poles and the zeroes of a transfer function can be drawn in the complex plane. Their position provide information about the frequency response³⁸ of the system. Indeed, the frequency response is equal to the transfer function taken for $s = i\omega$, which is along the imaginary axis.

$$\frac{Y(i\omega)}{X(i\omega)} = H(s = i\omega)$$

8.24.1 Effect of Poles

A stable LTI system³⁹ has all its poles on the left side half plane of s . If a pole would be located on the imaginary axis, at $p = i\omega_p$, then the factor $1/(s - p)$ of the transfer function would be infinite at the point $s = i\omega_p$ and so would the global frequency response $H(s = i\omega_p)$. For poles close to the imaginary axis, the frequency response takes a large amplitude for frequencies close to them. In other words, poles close to the imaginary axis indicate the passband.

8.24.2 Effect of Zeros

If a zero is located on the imaginary axis, at $z = i\omega_z$, then the factor $(s - z)$ of the transfer function is zero at the point $s = i\omega_z$ and so is the global frequency response $H(s = i\omega_z)$. Zeroes on, or close to the imaginary axis indicate the stopband.

8.25 Designing Filters

Devising the proper transfer function for a given filter function goes through the following steps:

- selecting a normalized filter function⁴⁰
- transforming and scaling⁴¹ the function for the particular needs

The coefficients of the numerator and denominator coefficients are finally used to calculate the element values of a selected filter circuit⁴².

38 http://en.wikibooks.org/wiki/Signals_and_Systems/Frequency_Response

39 http://en.wikibooks.org/wiki/Signal_Processing/Fourier_Analysis#LTI_Systems

40 http://en.wikibooks.org/wiki/Signals_and_Systems/Filter_Implementations

41 http://en.wikibooks.org/wiki/Signals_and_Systems/Filter_Transforms

42 http://en.wikibooks.org/wiki/Signal_Processing/Analog_Filters

8.25.1 Example: Lowpass Filter

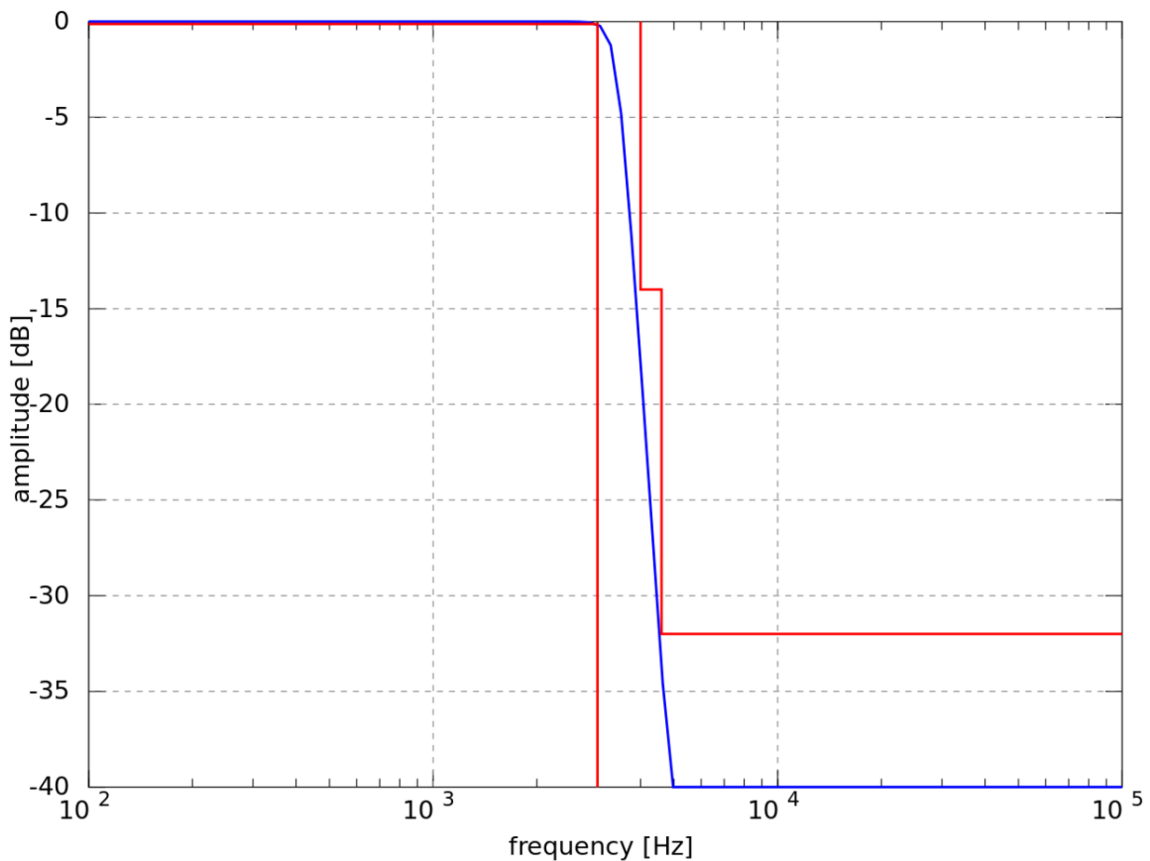

Figure 45 CCITT G712 input lowpass filter specification

A reduced version of CCITT G712 input filter specification, giving only the lowpass part, is shown in the plot on the side. The passband goes up to 3kHz and allows a maximal ripple of 0.125dB . The stopband requires an attenuation of 14dB at 4kHz and an attenuation of 32dB above 4.6kHz .

Filter Function

As a first step, we have to choose a filter function⁴³. Programs such as Octave⁴⁴ or Matlab provide functions which allow to determine the minimal filter order required to fulfill a given specification. This is a good help when choosing from the possible functions. Let's however here arbitrarily choose a Butterworth transfer function⁴⁵.

⁴³ http://en.wikibooks.org/wiki/Signals_and_Systems/Filter_Implementations

⁴⁴ http://en.wikibooks.org/wiki/Octave_Programming_Tutorial

⁴⁵ http://en.wikibooks.org/wiki/Signals_and_Systems/Filter_Implementations#Butterworth_Filters

Normalized Filter Function

The following Octave⁴⁶ script allows to plot the amplitudes of normalized Butterworth transfer functions from order 8 to 16.

```
#-----
-----
# Specifications
#
fs = 40E3;
fPass = 3000;
rPass = 0.125;
fStop1 = 4000;
rStop1 = 14;
fStop2 = 4600;
rStop2 = 32;

pointNb = 1000;
AdbMin = 40;

makeGraphics = 1;
figureIndex = 0;

#=====
=====
# Normalized filter function
#
wLog = 2*pi*logspace(-1, 1, pointNb);
fc = 0.87;
Adb = [];
for order = 8:16
    [num, den] = butter(order, 2*pi, 's');
    while ( length(num) < length(den) )
        num = [0, num];
    endwhile;
    Adb = [Adb; 20*log10(abs(freqls(num, den, wLog)))]';
endfor
Adb(Adb < -AdbMin) = -AdbMin;

figureIndex = figureIndex+1;
figure(figureIndex);

semilogx(wLog/(2*pi), Adb);
hold on;
semilogx([wLog(1)/(2*pi), fc, fc], -[rPass, rPass, AdbMin], 'r');
semilogx([fStop1*fc/fPass, fStop1*fc/fPass, fStop2*fc/fPass,
    fStop2*fc/fPass, wLog(length(wLog))/(2*pi)], ...
    -[0, rStop1, rStop1, rStop2, rStop2], 'r');
hold off;
axis([wLog(1)/(2*pi), wLog(length(wLog))/(2*pi), -AdbMin, 0]);
grid;
xlabel('frequency [Hz]');
ylabel('amplitude [dB]');

if (makeGraphics != 0)
    print -dsvg g712_butterworth_normalized.svg
endif
```

The following figure shows the result: one needs at least a 13th order Butterworth filter to meet the specifications.

⁴⁶ http://en.wikibooks.org/wiki/Octave_Programming_Tutorial

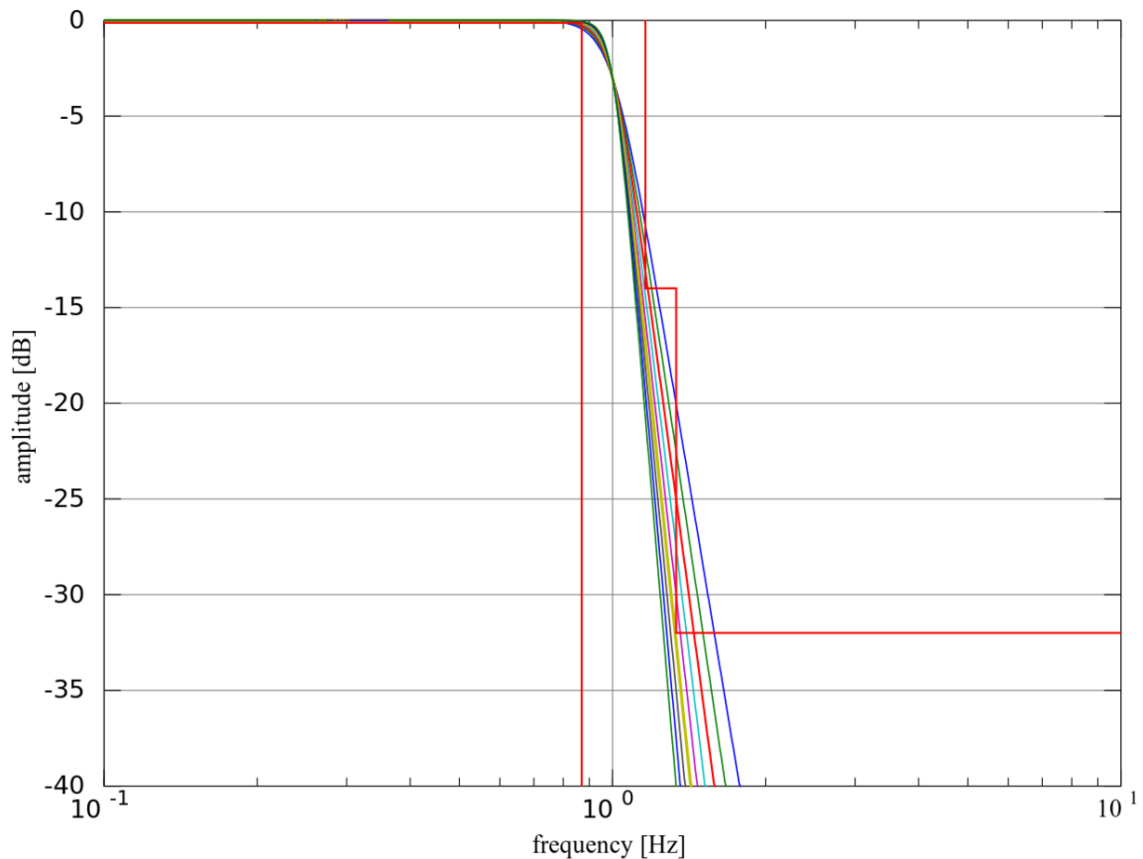

Figure 46 G712 butterworth normalized

On the graph, one can note that all the amplitude responses go through the same point at -3 dB. The specification frequencies have been scaled down to fit to the normalized cutoff frequency of 1 Hz. In the script, one might have noted an additional scaling factor of $f_c = 0.87$: this is due to the fact that the corner cutoff amplitude is -0.125 dB and not -3 dB. That value has been adjusted by hand for this example. Again, Octave or Matlab scripts automate this task.

Denormalized Filter Function

The frequency scaling⁴⁷ of the normalized transfer function is done by replacing $s \rightarrow f_c \cdot s$. The following Octave script does this by multiplying the numerator and denominator coefficients by the appropriate power of f_c .

```
#-----
# Denormalized filter function
#
order = 13;
wLog = 2*pi*logspace(2, 5, pointNb);
fc = 0.87;
```

⁴⁷ http://en.wikibooks.org/wiki/Signals_and_Systems/Filter_Transforms#Lowpass_to_Lowpass

```

[num, den] = butter(order, 2*pi, 's');
while ( length(num) < length(den) )
    num = [0, num];
endwhile;
for index = 1:order+1
    num(index) = num(index) * (fPass/fc)^(index-1);
    den(index) = den(index) * (fPass/fc)^(index-1);
endfor
Adb = 20*log10(abs(freqls(num, den, wLog)));
Adb(Adb < -AdbMin) = -AdbMin;

figureIndex = figureIndex+1;
figure(figureIndex);

semilogx(wLog/(2*pi), Adb);
hold on;
semilogx([wLog(1)/(2*pi), fPass, fPass], -[rPass, rPass, AdbMin],
    'r');
semilogx([fStop1, fStop1, fStop2, fStop2, wLog(length(wLog))/(2*pi)],
    ...
    -[0, rStop1, rStop1, rStop2, rStop2], 'r');
hold off;
axis([wLog(1)/(2*pi), wLog(length(wLog))/(2*pi), -AdbMin, 0]);
grid;
xlabel('frequency [Hz]');
ylabel('amplitude [dB]');

if (makeGraphics != 0)
    print -dsvg g712_butterworth.svg
endif

```

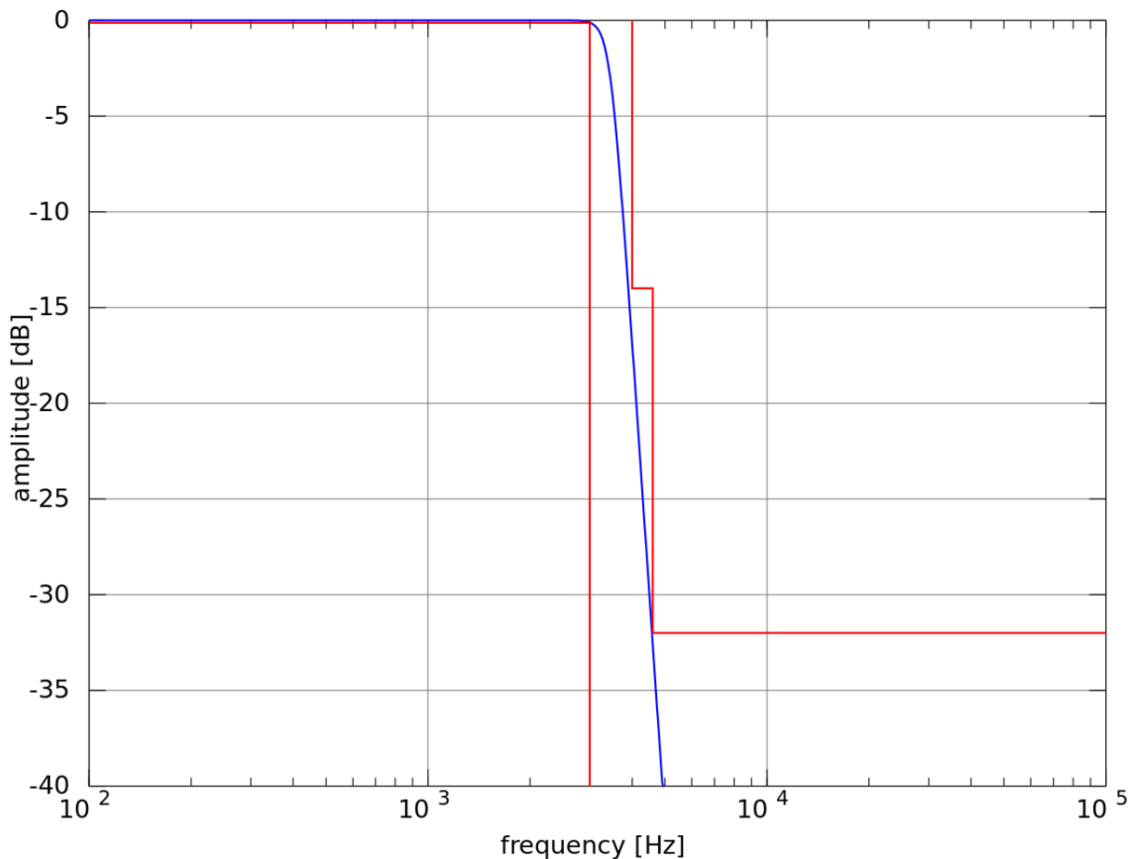

Figure 47 G712 butterworth

The coefficients of the numerator and denominator coefficients are now ready to be used to calculate the element values of a selected filter circuit⁴⁸.

48 http://en.wikibooks.org/wiki/Signal_Processing/Analog_Filters

9 Introduction to Digital Signals

9.1 Sampled Systems

Digital signals are by essence sampled signals. In a circuit node, the numbers change at a given rate: the *sampling rate* or *sampling frequency*. The time between two changes of the signal is the inverse of the sampling frequency: it is the *sampling period*. In processor systems, samples are stored in memory. In logic circuits, they correspond to register outputs. The sampling period is used to compute the next value of all signals in the system. Digital circuits are not the only sampled systems: analog circuits such as switched capacitor filters also rely on switches and are sampled too.

9.2 Sampling a signal

9.2.1 The Nyquist Rate

Sampling a signal raises a major question: does one lose information during this process?



Example: Checking (= sampling) the traffic lights once an hour certainly makes one erratically react to their signalling (= loose information). On the other side, sampling the traffic lights once per microsecond doesn't bring much more information than sampling it every millisecond. Obviously, the traffic lights, as any other signals, have to be sampled at a faster rate than they change, but sampling them very much faster doesn't bring more information.

The Nyquist rate¹ is the minimum sampling rate required to avoid loss of information.

$$f_N \stackrel{\text{def}}{=} 2f_b$$

where f_b is the highest frequency of the signal to be sampled, also called *bandwidth*. To avoid losing information, the sampling rate must be higher than the Nyquist rate:

$$f_s > f_N$$

In practice, the sampling rate is taken with some margin, in order to more easily reconstruct the original signal.

¹ http://en.wikipedia.org/wiki/Nyquist_rate



Example: audio content sampling rates² The full range of human hearing is between 20 Hz and 20 kHz. Thus, audio content has to be sampled at more than 40 kHz. And indeed:

- CD audio samples the signals at 44.1 kHz.
- Professional digital video equipment samples them at 48 kHz.
- DVD audio samples them at 96 kHz.
- High end DVD audio doubles this frequency to 192 kHz.

9.2.2 Aliasing

Sampling a signal with a rate lower than the Nyquist Rate produces aliasing³ or *folding*.

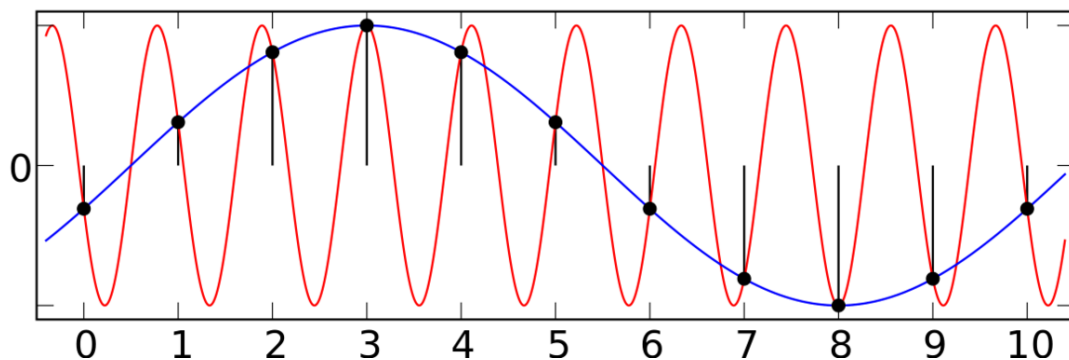

Figure 50 Effect of aliasing.

The picture on the right shows a red sinewave of frequency 0.9 (and thus of a period close to 1.1). This signal should be sampled with a frequency larger than 1.8. However, the signal has been sampled with a rate of 1 (vertical lines and black dots). If one tries to draw a line between the samples, the result will look like the blue curve which is a sinewave of period 10, or of frequency 0.1. If the signal would have been sampled at a rate of 0.9, the sampling points would always fall on the same point in the sine function and the resulting signal would seem to be a constant. Sampling a signal of frequency 0.9 with a rate of 1 creates an alias with the frequency of $1 - 0.9 = 0.1$. Sampling a signal of frequency 0.9 with a rate of 0.9 creates an alias at DC, and so with the frequency of $0.9 - 0.9 = 0$. Sampling a signal of frequency 0.9 with a rate of 0.8 also creates an alias with the frequency of $0.9 - 0.8 = 0.1$, but with a different phase.



² http://en.wikipedia.org/wiki/Sampling_rate

³ <http://en.wikipedia.org/wiki/Aliasing>

Example: A well known example of aliasing is the stroboscope. Illuminating a motor turning at a frequency of 90 Hz with a stroboscope switching at 100 Hz gives us the impression that it is turning at $100 \text{ Hz} - 90 \text{ Hz} = 10 \text{ Hz}$. Illuminating a motor turning at a frequency of 90 Hz with a stroboscope switching at 90 Hz gives us the impression that it is standing still. Illuminating a motor turning at a frequency of 90 Hz with a stroboscope switching at 80 Hz gives us the impression that it is turning at $90 \text{ Hz} - 80 \text{ Hz} = 10 \text{ Hz}$, but in the opposite direction.

It is as if the spectrum of the signal has been folded back down at a point equal to half the sampling frequency.

9.2.3 Undersampling

Sampling a a frequency lower than the Nyquist rate, also called *undersampling*, creates sinewave aliases at a lower frequency. If the original signal also has content at these lower frequencies, then they will be mixed and there is a loss of information. However, if the signal has only high-frequency content, then the undersampling process modulates the signal at a lower frequency. This is a cheap alternative to modulating by the multiplication with a modulation sinewave.

9.2.4 Oversampling

Oversampling corresponds to sampling with a frequency much higher (typically 100 to 1000) than the Nyquist rate. The interest of oversampling is to be able to represent the signal with a smaller amount of bits. This can be explained by the mechanism used to gain the additional bits back: a signal sampled at 10 kHz can be downsampled at 5 kHz as long as the new sampling frequency remains greater than the Nyquist frequency. The downsampling implies having two times fewer samples. Rather than throwing every second sample away, one can calculate the mean value of two consecutive samples and use this result to build one sample of the new signal. Calculating the mean value corresponds to add the values and divide them by two. Rather than dividing the result by two and throwing away the bit after the decimal point, one can only add the consecutive samples two by two. With this, the amplitude of the 5 kHz signal is twice the one of the original 10 kHz signal. In other words, it has to be represented by 1 more bits. A largely used application of oversampling is Pulse Width Modulation⁴ (PWM). The modulated signal is represented with a single bit switching at a frequency equal to $2^n \cdot f_N$, where f_N is the Nyquist frequency of the original signal and n the number of bits with which it is represented. This one bit signal is ideal to drive high-current loads with a single power switch. PWM is typically used for driving electric motors. A more complex coding scheme for a result on a single bit is found in every CD player: sigma-delta⁵ modulation. There is more theory required for understanding its working. Let us state that it is able to represent a signal on a single bit at a lower sampling frequency than the PWM. On the other hand, the one bit signal switches back and forth more frequently at its sampling frequency and is thus less indicated for driving

⁴ http://en.wikipedia.org/wiki/Pulse_width_modulation

⁵ http://en.wikipedia.org/wiki/Delta-sigma_modulation

slower high-current switches. Sigma-delta modulation is used for driving lighter loads such as the cable between the CD player and the audio amplifier.



Example: Super Audio CD⁶ (SACD) The SACD codes the audio in the form of a Direct Stream Digital⁷ signal coded on a single bit at 64 times the CD sampling rate of 44.1 kHz.

9.3 Z Transform

The *Z Transform* is used to represent sampled signals and Linear, Time Invariant⁸ (LTI) systems, such as filters, in a way similar to the Laplace transform representing continuous-time signals.

9.3.1 Signal representation

The *Z Transform* is used to represent sampled signals in a way similar to the Laplace transform representing continuous-time signals. A sampled signal is given by the sum of its samples, each one delayed by a different multiple of the sampling period. The Laplace transform represents a delay of one sampling period T_s by:

$$z^{-1} \stackrel{\text{def}}{=} e^{-sT_s}$$

With this, the Z-transform can be represented as

$$X(z) = \mathcal{Z}\{x[n]\} = \sum_{n=0}^{\infty} x[n]z^{-n}$$

where the $x[n]$ are the consecutive values of the sampled signal.

9.3.2 Linear time invariant systems

Continuous-time Linear Time Invariant (LTI) systems can be represented by a transfer function which is a fraction of two polynomials of the complex variable s .

$$H(s) = \frac{\text{num}(s)}{\text{den}(s)}$$

Their frequency response is estimated by taking $s = j\omega$, this is by estimating the transfer function along the imaginary axis. In order to ensure stability, the poles of the transfer function (the roots of the denominator polynomial) must be on the left half plane of s .

6 http://en.wikipedia.org/wiki/Super_Audio_CD

7 http://en.wikipedia.org/wiki/Direct_Stream_Digital

8 http://en.wikibooks.org/wiki/Signals_and_Systems/Time_Domain_Analysis#Linear_Time_Invariant_.28LTI.29_Systems

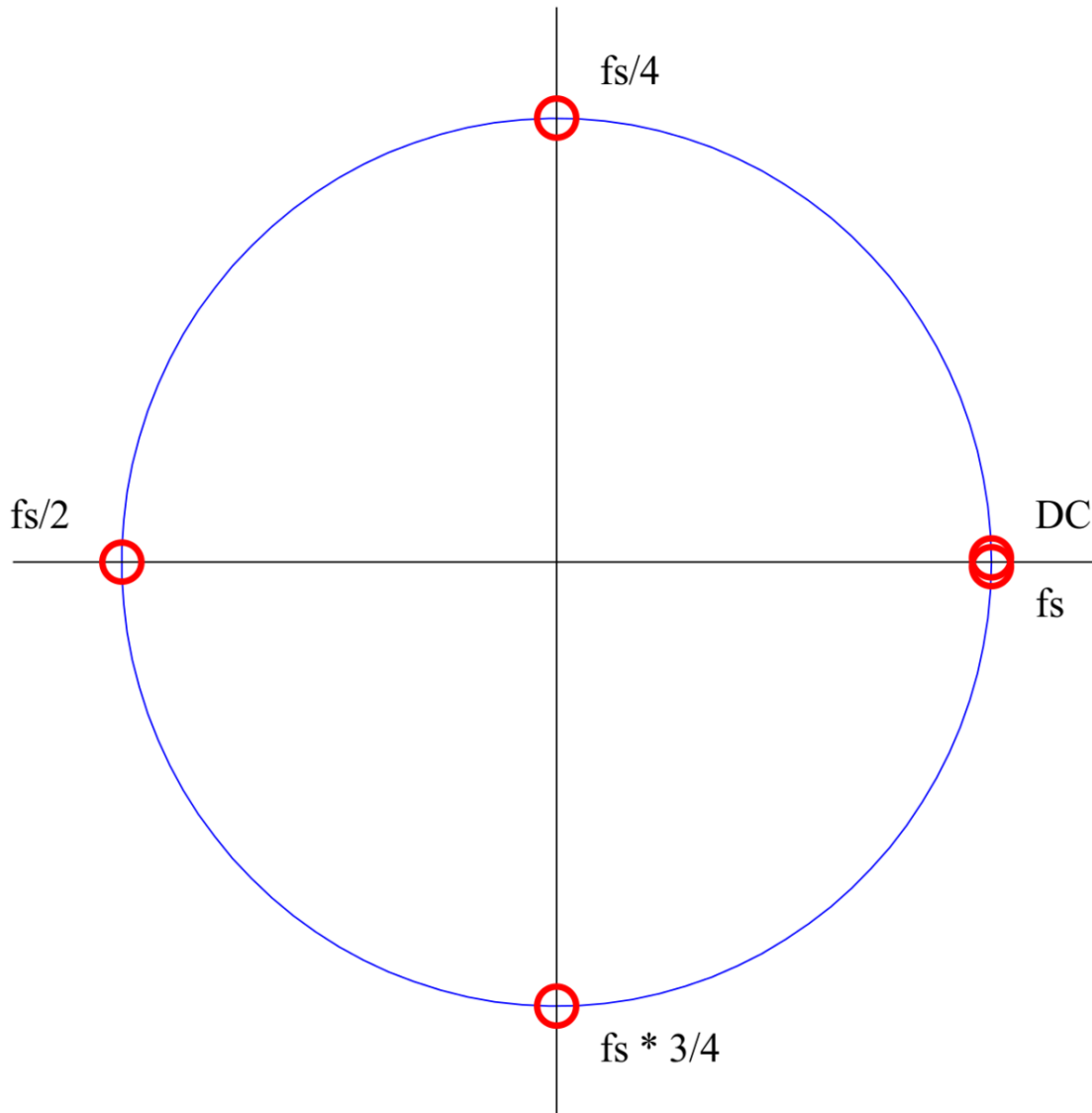

Figure 53 Z-plane unit circle

Discrete-time LTI systems can be represented by the fraction of two polynomials of the complex variable z :

$$H(z) = \frac{\text{num}(z)}{\text{den}(z)}$$

From the definition:

$$z \stackrel{\text{def}}{=} e^{sT_s}$$

we find that their frequency response can be estimated by taking $z = e^{j\omega T_s}$, this is by estimating the transfer function around the unit circle. In order to ensure stability, the poles of the transfer function (the roots of the denominator polynomial) must be inside the unit circle.

9.3.3 Transfer function periodicity

The transfer function is estimated around the unit circle:

- The point at coordinate $z = 1 + j0$ corresponds to frequency $f = 0$, which is DC.
- The point at coordinate $z = 0 + j1$ corresponds to frequency $f = f_s/4$, the quarter of the sampling frequency.
- The point at coordinate $z = -1 + j0$ corresponds to frequency $f = f_s/2$, half the sampling frequency.
- The point at coordinate $z = 0 - j1$ corresponds to frequency $f = 3/4f_s$.
- The point at coordinate $z = 1 + j0$ corresponds to frequency $f = f_s$ which is the sampling frequency.

So having turned once around the unit circle, one falls back to the starting point $z = 1 + j0$. From there, one can make another turn from f_s to $2f_s$, and one more from $2f_s$ to $3f_s$ and so on... On each of these turns, the frequency response will be the same. In other words, the transfer function of a sampled system is periodic of period equal to the sampling frequency. With real (as opposed to complex) signals, the transfer function is symmetric around half the sampling frequency: $f = f_s/2$. So the transfer function of a sampled system is usually only considered between $f = 0$ and $f = f_s/2$.

10 Appendices

Signals and Systems¹

10.1 Fourier Transform

$$F(j\omega) = \mathcal{F}\{f(t)\} = \int_{-\infty}^{\infty} f(t)e^{-j\omega t} dt$$

10.2 Inverse Fourier Transform

$$\mathcal{F}^{-1}\{F(j\omega)\} = f(t) = \frac{1}{2\pi} \int_{-\infty}^{\infty} F(j\omega)e^{j\omega t} d\omega$$

10.3 Table of Fourier Transforms

This table contains some of the most commonly encountered Fourier transforms.

	Time Domain	Frequency Domain
$x(t) = \mathcal{F}^{-1}\{X(\omega)\}$	$X(\omega) = \mathcal{F}\{x(t)\}$	
1	$X(j\omega) = \int_{-\infty}^{\infty} x(t)e^{-j\omega t} dt$	$x(t) = \frac{1}{2\pi} \int_{-\infty}^{\infty} X(j\omega)e^{j\omega t} d\omega$
2	1	$2\pi\delta(\omega)$
3	$-0.5 + u(t)$	$\frac{1}{j\omega}$
4	$\delta(t)$	1
5	$\delta(t - c)$	$e^{-j\omega c}$
6	$u(t)$	$\pi\delta(\omega) + \frac{1}{j\omega}$
7	$e^{-bt}u(t) (b \> 0)$	$\frac{1}{j\omega + b}$
8	$\cos\omega_0 t$	$\pi [\delta(\omega + \omega_0) + \delta(\omega - \omega_0)]$
9	$\cos(\omega_0 t + \theta)$	$\pi [e^{-j\theta}\delta(\omega + \omega_0) + e^{j\theta}\delta(\omega - \omega_0)]$
10	$\sin\omega_0 t$	$j\pi [\delta(\omega + \omega_0) - \delta(\omega - \omega_0)]$
11	$\sin(\omega_0 t + \theta)$	$j\pi [e^{-j\theta}\delta(\omega + \omega_0) - e^{j\theta}\delta(\omega - \omega_0)]$
12	$\text{rect}\left(\frac{t}{\tau}\right)$	$\tau \text{sinc}\left(\frac{\tau\omega}{2\pi}\right)$
13	$\tau \text{sinc}\left(\frac{\tau t}{2\pi}\right)$	$2\pi p_{\tau}(\omega)$
14	$\left(1 - \frac{2 t }{\tau}\right) p_{\tau}(t)$	$\frac{\tau}{2} \text{sinc}^2\left(\frac{\tau\omega}{4\pi}\right)$

¹ http://en.wikibooks.org/wiki/Signals_and_Systems

	Time Domain	Frequency Domain
$x(t) = \mathcal{F}^{-1}\{X(\omega)\}$	$X(\omega) = \mathcal{F}\{x(t)\}$	
15	$\frac{\tau}{2} \text{sinc}^2\left(\frac{\tau t}{4\pi}\right)$	$2\pi \left(1 - \frac{2 \omega }{\tau}\right) p_\tau(\omega)$
16	$e^{-a t }, \Re\{a\} > 0$	$\frac{2a}{a^2 + \omega^2}$
Notes:	<ol style="list-style-type: none"> 1. $\text{sinc}(x) = \sin(x)/x$ 2. $p_\tau(t)$ is the rectangular pulse function of width τ 3. $u(t)$ is the Heavyside step function 4. $\delta(t)$ is the Dirac delta function 	
This box: view ² • talk ³ • edit ⁴		

Signals and Systems⁵

10.4 Laplace Transform

$$F(s) = \mathcal{L}\{f(t)\} = \int_{0^-}^{\infty} e^{-st} f(t) dt.$$

10.5 Inverse Laplace Transform

$$\mathcal{L}^{-1}\{F(s)\} = \frac{1}{2\pi i} \int_{c-i\infty}^{c+i\infty} e^{ft} F(s) ds = f(t)$$

10.6 Laplace Transform Properties

Property	Definition
Linearity	$\mathcal{L}\{af(t) + bg(t)\} = aF(s) + bG(s)$
Differentiation	$\mathcal{L}\{f'\} = s\mathcal{L}\{f\} - f(0^-)$ $\mathcal{L}\{f''\} = s^2\mathcal{L}\{f\} - sf(0^-) - f'(0^-)$ $\mathcal{L}\{f^{(n)}\} = s^n\mathcal{L}\{f\} - s^{n-1}f(0^-) - \dots - f^{(n-1)}(0^-)$

2 http://en.wikibooks.org/wiki/Engineering_Tables/Fourier_Transform_Table
3 http://en.wikibooks.org/w/index.php?title=Talk:Engineering_Tables/Fourier_Transform_Table&action=edit&redlink=1
4 http://en.wikibooks.org/en.wikibooks.org/w/index.php?title=Engineering_Tables/Fourier_Transform_Table&action=edit
5 http://en.wikibooks.org/wiki/Signals_and_Systems

Property	Definition
Frequency Division	$\mathcal{L}\{tf(t)\} = -F'(s)$ $\mathcal{L}\{t^n f(t)\} = (-1)^n F^{(n)}(s)$
Frequency Integration	$\mathcal{L}\left\{\frac{f(t)}{t}\right\} = \int_s^\infty F(\sigma) d\sigma$
Time Integration	$\mathcal{L}\left\{\int_0^t f(\tau) d\tau\right\} = \mathcal{L}\{u(t) * f(t)\} = \frac{1}{s}F(s)$
Scaling	$\mathcal{L}\{f(at)\} = \frac{1}{a}F\left(\frac{s}{a}\right)$
Initial value theorem	$f(0^+) = \lim_{s \rightarrow \infty} sF(s)$
Final value theorem	$f(\infty) = \lim_{s \rightarrow 0} sF(s)$
Frequency Shifts	$\mathcal{L}\{e^{at}f(t)\} = F(s-a)$ $\mathcal{L}^{-1}\{F(s-a)\} = e^{at}f(t)$
Time Shifts	$\mathcal{L}\{f(t-a)u(t-a)\} = e^{-as}F(s)$ $\mathcal{L}^{-1}\{e^{-as}F(s)\} = f(t-a)u(t-a)$
Convolution Theorem	$\mathcal{L}\{f(t) * g(t)\} = F(s)G(s)$

Where:

$$f(t) = \mathcal{L}^{-1}\{F(s)\}$$

$$g(t) = \mathcal{L}^{-1}\{G(s)\}$$

$$s = \sigma + j\omega$$

10.7 Table of Laplace Transforms

	Time Domain	Laplace Domain
$x(t) = \mathcal{L}^{-1}\{X(s)\}$	$X(s) = \mathcal{L}\{x(t)\}$	
1	$\frac{1}{2\pi j} \int_{\sigma-j\infty}^{\sigma+j\infty} X(s)e^{st} ds$	$\int_{-\infty}^{\infty} x(t)e^{-st} dt$
2	$\delta(t)$	1
3	$\delta(t-a)$	e^{-as}
4	$u(t)$	$\frac{1}{s}$
5	$u(t-a)$	$\frac{e^{-as}}{s}$
6	$tu(t)$	$\frac{1}{s^2}$
7	$t^n u(t)$	$\frac{n!}{s^{n+1}}$
8	$\frac{1}{\sqrt{\pi t}}u(t)$	$\frac{1}{\sqrt{s}}$
9	$e^{at}u(t)$	$\frac{1}{s-a}$
10	$t^n e^{at}u(t)$	$\frac{n!}{(s-a)^{n+1}}$
11	$\cos(\omega t)u(t)$	$\frac{s}{s^2+\omega^2}$
12	$\sin(\omega t)u(t)$	$\frac{\omega}{s^2+\omega^2}$
13	$\cosh(\omega t)u(t)$	$\frac{s}{s^2-\omega^2}$
14	$\sinh(\omega t)u(t)$	$\frac{\omega}{s^2-\omega^2}$
15	$e^{at} \cos(\omega t)u(t)$	$\frac{s-a}{(s-a)^2+\omega^2}$
16	$e^{at} \sin(\omega t)u(t)$	$\frac{\omega}{(s-a)^2+\omega^2}$

	Time Domain	Laplace Domain
$x(t) = \mathcal{L}^{-1}\{X(s)\}$	$X(s) = \mathcal{L}\{x(t)\}$	
17	$\frac{1}{2\omega^3}(\sin \omega t - \omega t \cos \omega t)$	$\frac{1}{(s^2 + \omega^2)^2}$
18	$\frac{t}{2\omega} \sin \omega t$	$\frac{s}{(s^2 + \omega^2)^2}$
19	$\frac{1}{2\omega}(\sin \omega t + \omega t \cos \omega t)$	$\frac{s^2}{(s^2 + \omega^2)^2}$

Signals and Systems⁶

10.8 Useful Mathematical Identities

$\sin^2 \theta + \cos^2 \theta = 1$	$1 + \tan^2 \theta = \sec^2 \theta$
$\sin(\frac{\pi}{2} - \theta) = \cos \theta$	$\cos(\frac{\pi}{2} - \theta) = \sin \theta$
$\sec(\frac{\pi}{2} - \theta) = \csc \theta$	$\csc(\frac{\pi}{2} - \theta) = \sec \theta$
$\sin(-\theta) = -\sin \theta$	$\cos(-\theta) = \cos \theta$
$\sin 2\theta = 2 \sin \theta \cos \theta$	$\cos 2\theta = \cos^2 \theta - \sin^2 \theta = 2 \cos^2 \theta - 1 = 1 - 2 \sin^2 \theta$
$\sin^2 \theta = \frac{1 - \cos 2\theta}{2}$	$\cos^2 \theta = \frac{1 + \cos 2\theta}{2}$
$\sin \alpha + \sin \beta = 2 \sin(\frac{\alpha + \beta}{2}) \cos(\frac{\alpha - \beta}{2})$	$\sin \alpha - \sin \beta = 2 \cos(\frac{\alpha + \beta}{2}) \sin(\frac{\alpha - \beta}{2})$
$\cos \alpha + \cos \beta = 2 \cos(\frac{\alpha + \beta}{2}) \cos(\frac{\alpha - \beta}{2})$	$\cos \alpha - \cos \beta = -2 \sin(\frac{\alpha + \beta}{2}) \sin(\frac{\alpha - \beta}{2})$
$\sin \alpha \sin \beta = \frac{1}{2}[\cos(\alpha - \beta) - \cos(\alpha + \beta)]$	$\cos \alpha \cos \beta = \frac{1}{2}[\cos(\alpha - \beta) + \cos(\alpha + \beta)]$
$\sin \alpha \cos \beta = \frac{1}{2}[\sin(\alpha + \beta) + \sin(\alpha - \beta)]$	$1 + \cot^2 \theta = \csc^2 \theta$
$e^{j\theta} = \cos \theta + j \sin \theta$	$\cos \theta = \frac{e^{j\theta} + e^{-j\theta}}{2}$
$e^{-j\theta} = \cos \theta - j \sin \theta$	$\sin \theta = \frac{e^{j\theta} - e^{-j\theta}}{2j}$
$\tan(\frac{\pi}{2} - \theta) = \cot \theta$	$\cot(\frac{\pi}{2} - \theta) = \tan \theta$
$\tan(-\theta) = -\tan \theta$	
$\tan^2 \theta = \frac{1 - \cos 2\theta}{1 + \cos 2\theta}$	$\tan 2\theta = \frac{2 \tan \theta}{1 - \tan^2 \theta}$

Category⁷:

- Signals and Systems⁸

Hidden category:

- Requests for expansion⁹

⁶ http://en.wikibooks.org/wiki/Signals_and_Systems

⁷ <http://en.wikibooks.org/wiki/Special:Categories>

⁸ http://en.wikibooks.org/wiki/Category:Signals_and_Systems

⁹ http://en.wikibooks.org/wiki/Category:Requests_for_expansion

11 Contributors

Edits	User
2	A.toraby ¹
1	Adityapavan ²
8	Adrignola ³
1	Alshabz ⁴
1	Arthurvogel ⁵
1	Az1568 ⁶
1	British ⁷
1	ButterSoda ⁸
1	Courcelles ⁹
1	CyrilB ¹⁰
1	Cyrus Grisham ¹¹
1	Darklama ¹²
8	DavidCary ¹³
4	Dfrankow ¹⁴
1	Entropyslave ¹⁵
1	Fakalaos ¹⁶
65	Fcorthay ¹⁷
12	Feraudyh ¹⁸
5	Fishpi ¹⁹
1	FliesLikeABrick ²⁰
6	Gautamraj ²¹

1	http://en.wikibooks.org/w/index.php?title=User:A.toraby
2	http://en.wikibooks.org/w/index.php?title=User:Adityapavan
3	http://en.wikibooks.org/w/index.php?title=User:Adrignola
4	http://en.wikibooks.org/w/index.php?title=User:Alshabz
5	http://en.wikibooks.org/w/index.php?title=User:Arthurvogel
6	http://en.wikibooks.org/w/index.php?title=User:Az1568
7	http://en.wikibooks.org/w/index.php?title=User:British
8	http://en.wikibooks.org/w/index.php?title=User:ButterSoda
9	http://en.wikibooks.org/w/index.php?title=User:Courcelles
10	http://en.wikibooks.org/w/index.php?title=User:CyrilB
11	http://en.wikibooks.org/w/index.php?title=User:Cyrus_Grisham
12	http://en.wikibooks.org/w/index.php?title=User:Darklama
13	http://en.wikibooks.org/w/index.php?title=User:DavidCary
14	http://en.wikibooks.org/w/index.php?title=User:Dfrankow
15	http://en.wikibooks.org/w/index.php?title=User:Entropyslave
16	http://en.wikibooks.org/w/index.php?title=User:Fakalaos
17	http://en.wikibooks.org/w/index.php?title=User:Fcorthay
18	http://en.wikibooks.org/w/index.php?title=User:Feraudyh
19	http://en.wikibooks.org/w/index.php?title=User:Fishpi
20	http://en.wikibooks.org/w/index.php?title=User:FliesLikeABrick
21	http://en.wikibooks.org/w/index.php?title=User:Gautamraj

- 1 Greenbreen²²
- 1 Hagindaz²³
- 3 Hypergeek14²⁴
- 1 Iarlagab²⁵
- 18 Inductiveload²⁶
- 1 Jdenenberg²⁷
- 1 Jkaltes²⁸
- 8 Jobin RV²⁹
- 12 Jomegat³⁰
- 7 Jpkotta³¹
- 1 Jwillbur³²
- 1 Mattb112885³³
- 1 Mcbphd1³⁴
- 1 Mcleodm³⁵
- 1 Munkeegutz³⁶
- 1 Nijdam³⁷
- 2 Panic2k4³⁸
- 1 Patrick Star³⁹
- 1 Popen⁴⁰
- 8 QuiteUnusual⁴¹
- 18 Recent Runes⁴²
- 1 RedDragonAkai⁴³
- 1 Saptakniyogi⁴⁴
- 1 Savh⁴⁵
- 1 Shlomo Engelberg⁴⁶

-
- 22 <http://en.wikibooks.org/w/index.php?title=User:Greenbreen>
 - 23 <http://en.wikibooks.org/w/index.php?title=User:Hagindaz>
 - 24 <http://en.wikibooks.org/w/index.php?title=User:Hypergeek14>
 - 25 <http://en.wikibooks.org/w/index.php?title=User:Iarlagab>
 - 26 <http://en.wikibooks.org/w/index.php?title=User:Inductiveload>
 - 27 <http://en.wikibooks.org/w/index.php?title=User:Jdenenberg>
 - 28 <http://en.wikibooks.org/w/index.php?title=User:Jkaltes>
 - 29 http://en.wikibooks.org/w/index.php?title=User:Jobin_RV
 - 30 <http://en.wikibooks.org/w/index.php?title=User:Jomegat>
 - 31 <http://en.wikibooks.org/w/index.php?title=User:Jpkotta>
 - 32 <http://en.wikibooks.org/w/index.php?title=User:Jwillbur>
 - 33 <http://en.wikibooks.org/w/index.php?title=User:Mattb112885>
 - 34 <http://en.wikibooks.org/w/index.php?title=User:Mcbphd1>
 - 35 <http://en.wikibooks.org/w/index.php?title=User:Mcleodm>
 - 36 <http://en.wikibooks.org/w/index.php?title=User:Munkeegutz>
 - 37 <http://en.wikibooks.org/w/index.php?title=User:Nijdam>
 - 38 <http://en.wikibooks.org/w/index.php?title=User:Panic2k4>
 - 39 http://en.wikibooks.org/w/index.php?title=User:Patrick_Star
 - 40 <http://en.wikibooks.org/w/index.php?title=User:Popen>
 - 41 <http://en.wikibooks.org/w/index.php?title=User:QuiteUnusual>
 - 42 http://en.wikibooks.org/w/index.php?title=User:Recent_Runes
 - 43 <http://en.wikibooks.org/w/index.php?title=User:RedDragonAkai>
 - 44 <http://en.wikibooks.org/w/index.php?title=User:Saptakniyogi>
 - 45 <http://en.wikibooks.org/w/index.php?title=User:Savh>
 - 46 http://en.wikibooks.org/w/index.php?title=User:Shlomo_Engelberg

- 1 Siddhu8990⁴⁷
- 1 Sigma 7⁴⁸
- 2 Simoneau⁴⁹
- 1 Sknister⁵⁰
- 3 Thenub314⁵¹
- 1 Upul⁵²
- 1 Van der Hoorn⁵³
- 1 Vivek.cd⁵⁴
- 1 WarrenSmith⁵⁵
- 275 Whiteknight⁵⁶
- 1 Wtachi⁵⁷
- 4 Xania⁵⁸
- 4 Xris⁵⁹
- 2 YMS⁶⁰
- 4 Yatharth⁶¹

-
- 47 <http://en.wikibooks.org/w/index.php?title=User:Siddhu8990>
 - 48 http://en.wikibooks.org/w/index.php?title=User:Sigma_7
 - 49 <http://en.wikibooks.org/w/index.php?title=User:Simoneau>
 - 50 <http://en.wikibooks.org/w/index.php?title=User:Sknister>
 - 51 <http://en.wikibooks.org/w/index.php?title=User:Thenub314>
 - 52 <http://en.wikibooks.org/w/index.php?title=User:Upul>
 - 53 http://en.wikibooks.org/w/index.php?title=User:Van_der_Hoorn
 - 54 <http://en.wikibooks.org/w/index.php?title=User:Vivek.cd>
 - 55 <http://en.wikibooks.org/w/index.php?title=User:WarrenSmith>
 - 56 <http://en.wikibooks.org/w/index.php?title=User:Whiteknight>
 - 57 <http://en.wikibooks.org/w/index.php?title=User:Wtachi>
 - 58 <http://en.wikibooks.org/w/index.php?title=User:Xania>
 - 59 <http://en.wikibooks.org/w/index.php?title=User:Xris>
 - 60 <http://en.wikibooks.org/w/index.php?title=User:YMS>
 - 61 <http://en.wikibooks.org/w/index.php?title=User:Yatharth>

List of Figures

- GFDL: Gnu Free Documentation License. <http://www.gnu.org/licenses/fdl.html>
- cc-by-sa-3.0: Creative Commons Attribution ShareAlike 3.0 License. <http://creativecommons.org/licenses/by-sa/3.0/>
- cc-by-sa-2.5: Creative Commons Attribution ShareAlike 2.5 License. <http://creativecommons.org/licenses/by-sa/2.5/>
- cc-by-sa-2.0: Creative Commons Attribution ShareAlike 2.0 License. <http://creativecommons.org/licenses/by-sa/2.0/>
- cc-by-sa-1.0: Creative Commons Attribution ShareAlike 1.0 License. <http://creativecommons.org/licenses/by-sa/1.0/>
- cc-by-2.0: Creative Commons Attribution 2.0 License. <http://creativecommons.org/licenses/by/2.0/>
- cc-by-2.0: Creative Commons Attribution 2.0 License. <http://creativecommons.org/licenses/by/2.0/deed.en>
- cc-by-2.5: Creative Commons Attribution 2.5 License. <http://creativecommons.org/licenses/by/2.5/deed.en>
- cc-by-3.0: Creative Commons Attribution 3.0 License. <http://creativecommons.org/licenses/by/3.0/deed.en>
- GPL: GNU General Public License. <http://www.gnu.org/licenses/gpl-2.0.txt>
- LGPL: GNU Lesser General Public License. <http://www.gnu.org/licenses/lgpl.html>
- PD: This image is in the public domain.
- ATTR: The copyright holder of this file allows anyone to use it for any purpose, provided that the copyright holder is properly attributed. Redistribution, derivative work, commercial use, and all other use is permitted.
- EURO: This is the common (reverse) face of a euro coin. The copyright on the design of the common face of the euro coins belongs to the European Commission. Authorised reproduction in a format without relief (drawings, paintings, films) provided they are not detrimental to the image of the euro.
- LFK: Lizenz Freie Kunst. <http://artlibre.org/licence/lal/de>
- CFR: Copyright free use.

- EPL: Eclipse Public License. <http://www.eclipse.org/org/documents/epl-v10.php>

Copies of the GPL, the LGPL as well as a GFDL are included in chapter Licenses⁶². Please note that images in the public domain do not require attribution. You may click on the image numbers in the following table to open the webpage of the images in your webbrowser.

⁶² Chapter 12 on page 117

1	The people from the Tango! project ⁶³	PD
2		PD
3		PD
4		GFDL
5		GFDL
6		GFDL
7		GFDL
8		GFDL
9	Inductiveload ⁶⁴	PD
10	Inductiveload ⁶⁵	PD
11	Inductiveload ⁶⁶	PD
12	Inductiveload ⁶⁷	PD
13	Inductiveload ⁶⁸	PD
14	Inductiveload ⁶⁹	PD
15	Inductiveload ⁷⁰	PD
16		
17	El T ⁷¹	PD
18	Inductiveload ⁷²	PD
19	Inductiveload ⁷³	PD
20	Inductiveload ⁷⁴	PD
21	Inductiveload ⁷⁵	PD
22	Inductiveload ⁷⁶	PD
23	Inductiveload ⁷⁷	PD
24	Inductiveload ⁷⁸	PD
25	Inductiveload ⁷⁹	PD
26	Inductiveload ⁸⁰	PD
27	Inductiveload ⁸¹	PD
28	Inductiveload ⁸²	PD
29	Artwork by Tuomas Kuosmanen <tigert_at_ximian.com> and Jakub Steiner <jimmac_at_ximian.com>	GPL
30	Inductiveload ⁸³	PD

- 63 http://tango.freedesktop.org/The_People
- 64 <http://en.wikibooks.org/wiki/User%3AInductiveload>
- 65 <http://en.wikibooks.org/wiki/User%3AInductiveload>
- 66 <http://en.wikibooks.org/wiki/User%3AInductiveload>
- 67 <http://en.wikibooks.org/wiki/User%3AInductiveload>
- 68 <http://en.wikibooks.org/wiki/User%3AInductiveload>
- 69 <http://en.wikibooks.org/wiki/User%3AInductiveload>
- 70 <http://en.wikibooks.org/wiki/User%3AInductiveload>
- 71 <http://en.wikibooks.org/wiki/%3Aw%3Aen%3AE1%20T>
- 72 <http://en.wikibooks.org/wiki/User%3AInductiveload>
- 73 <http://en.wikibooks.org/wiki/User%3AInductiveload>
- 74 <http://en.wikibooks.org/wiki/User%3AInductiveload>
- 75 <http://en.wikibooks.org/wiki/User%3AInductiveload>
- 76 <http://en.wikibooks.org/wiki/User%3AInductiveload>
- 77 <http://en.wikibooks.org/wiki/User%3AInductiveload>
- 78 <http://en.wikibooks.org/wiki/User%3AInductiveload>
- 79 <http://en.wikibooks.org/wiki/User%3AInductiveload>
- 80 <http://en.wikibooks.org/wiki/User%3AInductiveload>
- 81 <http://en.wikibooks.org/wiki/User%3AInductiveload>
- 82 <http://en.wikibooks.org/wiki/User%3AInductiveload>
- 83 <http://en.wikibooks.org/wiki/User%3AInductiveload>

31	Inductiveload ⁸⁴	PD
32	Inductiveload ⁸⁵	PD
33	Inductiveload ⁸⁶	PD
34	Inductiveload ⁸⁷	PD
35	Inductiveload ⁸⁸	PD
36	Inductiveload ⁸⁹	PD
37	Inductiveload ⁹⁰	PD
38	Inductiveload ⁹¹	PD
39	Fcorthay ⁹²	cc-by-sa-3.0
40	Inductiveload ⁹³	PD
41	Inductiveload ⁹⁴	PD
42	User:PAR	PD
43	Alessio Damato ⁹⁵	GFDL
44		GFDL
45	Fcorthay ⁹⁶	cc-by-sa-3.0
46	Fcorthay ⁹⁷	GFDL
47	Fcorthay ⁹⁸	GFDL
48	Artwork by Tuomas Kuosmanen <tigert_at_ximian.com> and Jakub Steiner <jimmac_at_ximian.com>	GPL
49	Artwork by Tuomas Kuosmanen <tigert_at_ximian.com> and Jakub Steiner <jimmac_at_ximian.com>	GPL
50	Moxfyre ⁹⁹	GFDL
51	Artwork by Tuomas Kuosmanen <tigert_at_ximian.com> and Jakub Steiner <jimmac_at_ximian.com>	GPL
52	Artwork by Tuomas Kuosmanen <tigert_at_ximian.com> and Jakub Steiner <jimmac_at_ximian.com>	GPL
53	Fcorthay ¹⁰⁰	cc-by-sa-3.0

-
- 84 <http://en.wikibooks.org/wiki/User%3AInductiveload>
85 <http://en.wikibooks.org/wiki/User%3AInductiveload>
86 <http://en.wikibooks.org/wiki/User%3AInductiveload>
87 <http://en.wikibooks.org/wiki/User%3AInductiveload>
88 <http://en.wikibooks.org/wiki/User%3AInductiveload>
89 <http://en.wikibooks.org/wiki/User%3AInductiveload>
90 <http://en.wikibooks.org/wiki/User%3AInductiveload>
91 <http://en.wikibooks.org/wiki/User%3AInductiveload>
92 <http://en.wikibooks.org/wiki/User%3AFcorthay>
93 <http://en.wikibooks.org/wiki/User%3AInductiveload>
94 <http://en.wikibooks.org/wiki/User%3AInductiveload>
95 <http://en.wikibooks.org/wiki/User%3AAlejo2083>
96 <http://en.wikibooks.org/wiki/User%3AFcorthay>
97 <http://en.wikibooks.org/wiki/User%3AFcorthay>
98 <http://en.wikibooks.org/wiki/User%3AFcorthay>
99 <http://en.wikibooks.org/wiki/User%3AMoxfyre>
100 <http://en.wikibooks.org/wiki/User%3AFcorthay>

12 Licenses

12.1 GNU GENERAL PUBLIC LICENSE

Version 3, 29 June 2007

Copyright © 2007 Free Software Foundation, Inc.
<<http://fsf.org/>>

Everyone is permitted to copy and distribute verbatim copies of this license document, but changing it is not allowed. Preamble

The GNU General Public License is a free, copyleft license for software and other kinds of works.

The licenses for most software and other practical works are designed to take away your freedom to share and change the works. By contrast, the GNU General Public License is intended to guarantee your freedom to share and change all versions of a program—to make sure it remains free software for all its users. We, the Free Software Foundation, use the GNU General Public License for most of our software; it applies also to any other work released this way by its authors. You can apply it to your programs, too.

When we speak of free software, we are referring to freedom, not price. Our General Public Licenses are designed to make sure that you have the freedom to distribute copies of free software (and charge for them if you wish), that you receive source code or can get it if you want it, that you can change the software or use pieces of it in new free programs, and that you know you can do these things.

To protect your rights, we need to prevent others from denying you these rights or asking you to surrender the rights. Therefore, you have certain responsibilities if you distribute copies of the software, or if you modify it: responsibilities to respect the freedom of others.

For example, if you distribute copies of such a program, whether gratis or for a fee, you must pass on to the recipients the same freedoms that you received. You must make sure that they, too, receive or can get the source code. And you must show them these terms so they know their rights.

Developers that use the GNU GPL protect your rights with two steps: (1) assert copyright on the software, and (2) offer you this License giving you legal permission to copy, distribute and/or modify it.

For the developers' and authors' protection, the GPL clearly explains that there is no warranty for this free software. For both users' and authors' sake, the GPL requires that modified versions be marked as changed, so that their problems will not be attributed erroneously to authors of previous versions.

Some devices are designed to deny users access to install or run modified versions of the software inside them, although the manufacturer can do so. This is fundamentally incompatible with the aim of protecting users' freedom to change the software. The systematic pattern of such abuse occurs in the area of products for individuals to use, which is precisely where it is most unacceptable. Therefore, we have designed this version of the GPL to prohibit the practice for those products. If such problems arise substantially in other domains, we stand ready to extend this provision to those domains in future versions of the GPL, as needed to protect the freedom of users.

Finally, every program is threatened constantly by software patents. States should not allow patents to restrict development and use of software on general-purpose computers, but in those that do, we wish to avoid the special danger that patents applied to a free program could make it effectively proprietary. To prevent this, the GPL assures that patents cannot be used to render the program non-free.

The precise terms and conditions for copying, distribution and modification follow. TERMS AND CONDITIONS 0. Definitions.

"This License" refers to version 3 of the GNU General Public License.

"Copyright" also means copyright-like laws that apply to other kinds of works, such as semiconductor masks.

"The Program" refers to any copyrightable work licensed under this License. Each licensee is addressed as "you". "Licensees" and "recipients" may be individuals or organizations.

To "modify" a work means to copy from or adapt all or part of the work in a fashion requiring copyright permission, other than the making of an exact copy. The resulting work is called a "modified version" of the earlier work or a work "based on" the earlier work.

A "covered work" means either the unmodified Program or a work based on the Program.

To "propagate" a work means to do anything with it that, without permission, would make you directly or secondarily liable for infringement under applicable copyright law, except executing it on a computer or modifying a private copy. Propagation includes copying, distribution (with or without modification), making available to the public, and in some countries other activities as well.

To "convey" a work means any kind of propagation that enables other parties to make or receive copies. Mere interaction with a user through a computer

network, with no transfer of a copy, is not conveying.

An interactive user interface displays "Appropriate Legal Notices" to the extent that it includes a convenient and prominently visible feature that (1) displays an appropriate copyright notice, and (2) tells the user that there is no warranty for the work (except to the extent that warranties are provided), that licensees may convey the work under this License, and how to view a copy of this License. If the interface presents a list of user commands or options, such as a menu, a prominent item in the list meets this criterion. 1. Source Code.

The "source code" for a work means the preferred form of the work for making modifications to it. "Object code" means any non-source form of a work.

A "Standard Interface" means an interface that either is an official standard defined by a recognized standards body, or, in the case of interfaces specified for a particular programming language, one that is widely used among developers working in that language.

The "System Libraries" of an executable work include anything, other than the work as a whole, that (a) is included in the normal form of packaging a Major Component, but which is not part of that Major Component, and (b) serves only to enable use of the work with that Major Component, or to implement a Standard Interface for which an implementation is available to the public in source code form. A "Major Component", in this context, means a major essential component (kernel, window system, and so on) of the specific operating system (if any) on which the executable work runs, or a compiler used to produce the work, or an object code interpreter used to run it.

The "Corresponding Source" for a work in object code form means all the source code needed to generate, install, and (for an executable work) run the object code and to modify the work, including scripts to control those activities. However, it does not include the work's System Libraries, or general-purpose tools or generally available free programs which are used unmodified in performing those activities but which are not part of the work. For example, Corresponding Source includes interface definition files associated with source files for the work, and the source code for shared libraries and dynamically linked subprograms that the work is specifically designed to require, such as by intimate data communication or control flow between those subprograms and other parts of the work.

The Corresponding Source need not include anything that users can regenerate automatically from other parts of the Corresponding Source.

The Corresponding Source for a work in source code form is that same work. 2. Basic Permissions.

All rights granted under this License are granted for the term of copyright on the Program, and are irrevocable provided the stated conditions are met. This License explicitly affirms your unlimited permission to run the unmodified Program. The output from running a covered work is covered by this License only if the output, given its content, constitutes a covered work. This License acknowledges your rights of fair use or other equivalent, as provided by copyright law.

You may make, run and propagate covered works that you do not convey, without conditions so long as your license otherwise remains in force. You may convey covered works to others for the sole purpose of having them make modifications exclusively for you, or provide you with facilities for running those works, provided that you comply with the terms of this License in conveying all material for which you do not control copyright. Those thus making or running the covered works for you must do so exclusively on your behalf, under your direction and control, on terms that prohibit them from making any copies of your copyrighted material outside their relationship with you.

Conveying under any other circumstances is permitted solely under the conditions stated below. Sublicensing is not allowed; section 10 makes it unnecessary. 3. Protecting Users' Legal Rights From Anti-Circumvention Law.

No covered work shall be deemed part of an effective technological measure under any applicable law fulfilling obligations under article 11 of the WIPO copyright treaty adopted on 20 December 1996, or similar laws prohibiting or restricting circumvention of such measures.

When you convey a covered work, you waive any legal power to forbid circumvention of technological measures to the extent such circumvention is effected by exercising rights under this License with respect to the covered work, and you disclaim any intention to limit operation or modification of the work as a means of enforcing, against the work's users, your or third parties' legal rights to forbid circumvention of technological measures. 4. Conveying Verbatim Copies.

You may convey verbatim copies of the Program's source code as you receive it, in any medium, provided that you conspicuously and appropriately publish on each copy an appropriate copyright notice; keep intact all notices stating that this License and any non-permissive terms added in accord with section 7 apply to the code; keep intact all notices of the absence of any warranty; and give all recipients a copy of this License along with the Program.

You may charge any price or no price for each copy that you convey, and you may offer support or warranty protection for a fee. 5. Conveying Modified Source Versions.

You may convey a work based on the Program, or the modifications to produce it from the Program, in the form of source code under the terms of section 4, provided that you also meet all of these conditions:

- * a) The work must carry prominent notices stating that you modified it, and giving a relevant date. *
- b) The work must carry prominent notices stating that it is released under this License and any conditions added under section 7. This requirement modifies the requirement in section 4 to "keep intact all notices". *
- c) You must license the entire work, as a whole, under this License to anyone who comes into possession of a copy. This License will therefore apply, along with any applicable section 7 additional terms, to the whole of the work, and all its parts, regardless of how they are packaged. This License gives no permission to license the work in any other way, but it does not invalidate such permission if you have separately received it. *
- d) If the work has interactive user interfaces, each must display Appropriate Legal Notices; however, if the Program has interactive interfaces that do not display Appropriate Legal Notices, your work need not make them do so.

A compilation of a covered work with other separate and independent works, which are not by their nature extensions of the covered work, and which are not combined with it such as to form a larger program, in or on a volume of a storage or distribution medium, is called an "aggregate" if the compilation and its resulting copyright are not used to limit the access or legal rights of the compilation's users beyond what the individual works permit. Inclusion of a covered work in an aggregate does not cause this License to apply to the other parts of the aggregate. 6. Conveying Non-Source Forms.

You may convey a covered work in object code form under the terms of sections 4 and 5, provided that you also convey the machine-readable Corresponding Source under the terms of this License, in one of these ways:

- * a) Convey the object code in, or embodied in, a physical product (including a physical distribution medium), accompanied by the Corresponding Source fixed on a durable physical medium customarily used for software interchange. *
- b) Convey the object code in, or embodied in, a physical product (including a physical distribution medium), accompanied by a written offer, valid for at least three years and valid for as long as you offer spare parts or customer support for that product model, to give anyone who possesses the object code either (1) a copy of the Corresponding Source for all the software in the product that is covered by this License, on a durable physical medium customarily used for software interchange, for a price no more than your reasonable cost of physically performing this conveying of source, or (2) access to copy the Corresponding Source from a network server at no charge. *
- c) Convey individual copies of the object code with a copy of the written offer to provide the Corresponding Source. This alternative is allowed only occasionally and noncommercially, and only if you received the object code with such an offer, in accord with subsection 6b. *
- d) Convey the object code by offering access from a designated place (gratis or for a charge), and offer equivalent access to the Corresponding Source in the same way through the same place at no further charge. You need not require recipients to copy the Corresponding Source along with the object code. If the place to copy the object code is a network server, the Corresponding Source may be on a different server (operated by you or a third party) that supports equivalent copying facilities, provided you maintain clear directions next to the object code saying where to find the Corresponding Source. Regardless of what server hosts the Corresponding Source, you remain obligated to ensure that it is available for as long as needed to satisfy these requirements. *
- e) Convey the object code using peer-to-peer transmission, provided you inform other peers where the object code and Corresponding Source of the work are being offered to the general public at no charge under subsection 6d.

A separable portion of the object code, whose source code is excluded from the Corresponding Source as a System Library, need not be included in conveying the object code work.

A "User Product" is either (1) a "consumer product", which means any tangible personal property which is normally used for personal, family, or household purposes, or (2) anything designed or sold for incorporation into a dwelling. In determining whether a product is a consumer product, doubtful cases shall be resolved in favor of coverage. For a particular product received by a particular user, "normally used" refers to a typical or common use of that class of product, regardless of the status of the particular user or of the way in which the particular user actually uses, or expects or is expected to use, the product. A product is a consumer product regardless of whether the product has substantial commercial, industrial or non-consumer uses, unless such uses represent the only significant mode of use of the product.

"Installation Information" for a User Product means any methods, procedures, authorization keys, or other information required to install and execute modified versions of a covered work in that User Product from a modified version of its Corresponding Source. The information must suffice to ensure that the continued functioning of the modified object code is in no case prevented or interfered with solely because modification has been made.

If you convey an object code work under this section in, or with, or specifically for use in, a User Product, and the conveying occurs as part of a transaction in which the right of possession and use of the User Product is transferred to the recipient in perpetuity or for a fixed term (regardless of how the transaction is characterized), the Corresponding Source conveyed under this section must be accompanied by the Installation Information. But this requirement does not apply if neither you nor any third party retains the ability to install modified object code on the User Product (for example, the work has been installed in ROM).

The requirement to provide Installation Information does not include a requirement to continue to provide support service, warranty, or updates for a work that has been modified or installed by the recipient, or for the User Product in which it has been modified or installed. Access to a network may be denied when the modification itself materially and adversely affects the operation of the network or violates the rules and protocols for communication across the network.

Corresponding Source conveyed, and Installation Information provided, in accord with this section must be in a format that is publicly documented (and with an implementation available to the public in source code form), and must require no special password or key for unpacking, reading or copying. 7. Additional Terms.

"Additional permissions" are terms that supplement the terms of this License by making exceptions from one or more of its conditions. Additional permissions that are applicable to the entire Program shall be treated as though they were included in this License, to the extent that they are valid under applicable law. If additional permissions apply only to part of the Program, that part may be used separately under those permissions, but the entire Program remains governed by this License without regard to the additional permissions.

When you convey a copy of a covered work, you may at your option remove any additional permissions from that copy, or from any part of it. (Additional permissions may be written to require their own removal in certain cases when you modify the work.) You may place additional permissions on material, added by you to a covered work, for which you have or can give appropriate copyright permission.

Notwithstanding any other provision of this License, for material you add to a covered work, you may (if authorized by the copyright holders of that material) supplement the terms of this License with terms:

- * a) Disclaiming warranty or limiting liability differently from the terms of sections 15 and 16 of this License; or *
- b) Requiring preservation of specified reasonable legal notices or author attributions in that material or in the Appropriate Legal Notices displayed by works containing it; or *
- c) Prohibiting misrepresentation of the origin of that material, or requiring that modified versions of such material be marked in reasonable ways as different from the original version; or *
- d) Limiting the use for publicity purposes of names of licensors or authors of the material; or *
- e) Declining to grant rights under trademark law for use of some trade names, trademarks, or service marks; or *
- f) Requiring indemnification of licensors and authors of that material by anyone who conveys the material (or modified versions of it) with contractual assumptions of liability to the recipient, for any liability that these contractual assumptions directly impose on those licensors and authors.

All other non-permissive additional terms are considered "further restrictions" within the meaning of section 10. If the Program as you received it, or any part of it, contains a notice stating that it is governed by this License along with a term that is a further restriction, you may remove that term. If a license document contains a further restriction but permits relicensing or conveying under this License, you may add to a covered work material governed by the terms of that license document, provided that the further restriction does not survive such relicensing or conveying.

If you add terms to a covered work in accord with this section, you must place, in the relevant source files, a statement of the additional terms that apply to those files, or a notice indicating where to find the applicable terms.

Additional terms, permissive or non-permissive, may be stated in the form of a separately written license, or stated as exceptions; the above requirements apply either way. 8. Termination.

You may not propagate or modify a covered work except as expressly provided under this License. Any attempt otherwise to propagate or modify it is void, and will automatically terminate your rights under this License (including any patent licenses granted under the third paragraph of section 11).

However, if you cease all violation of this License, then your license from a particular copyright holder is reinstated (a) provisionally, unless and until the copyright holder explicitly and finally terminates your license, and (b) permanently, if the copyright holder fails to notify you of the violation by some reasonable means prior to 60 days after the cessation.

Moreover, your license from a particular copyright holder is reinstated permanently if the copyright holder notifies you of the violation by some reasonable means, this is the first time you have received notice of violation of this License (for any work)

from that copyright holder, and you cure the violation prior to 30 days after your receipt of the notice.

Termination of your rights under this section does not terminate the licenses of parties who have received copies or rights from you under this License. If your rights have been terminated and not permanently reinstated, you do not qualify to receive new licenses for the same material under section 10. 9. Acceptance Not Required for Having Copies.

You are not required to accept this License in order to receive or run a copy of the Program. Ancillary propagation of a covered work occurring solely as a consequence of using peer-to-peer transmission to receive a copy likewise does not require acceptance. However, nothing other than this License grants you permission to propagate or modify any covered work. These actions infringe copyright if you do not accept this License. Therefore, by modifying or propagating a covered work, you indicate your acceptance of this License to do so. 10. Automatic Licensing of Downstream Recipients.

Each time you convey a covered work, the recipient automatically receives a license from the original licensors, to run, modify and propagate that work, subject to this License. You are not responsible for enforcing compliance by third parties with this License.

An "entity transaction" is a transaction transferring control of an organization, or substantially all assets of one, or subdividing an organization, or merging organizations. If propagation of a covered work results from an entity transaction, each party to that transaction who receives a copy of the work also receives whatever licenses to the work the party's predecessor in interest had or could give under the previous paragraph, plus a right to possession of the Corresponding Source of the work from the predecessor in interest had or could give if it or can get it with reasonable efforts.

You may not impose any further restrictions on the exercise of the rights granted or affirmed under this License. For example, you may not impose a license fee, royalty, or other charge for exercise of rights granted under this License, and you may not initiate litigation (including a cross-claim or counterclaim in a lawsuit) alleging that any patent claim is infringed by making, using, selling, offering for sale, or importing the Program or any portion of it. 11. Patents.

A "contributor" is a copyright holder who authorizes use under this License of the Program or a work on which the Program is based. The work thus licensed is called the contributor's "contributor version".

A contributor's "essential patent claims" are all patent claims owned or controlled by the contributor, whether already acquired or hereafter acquired, that would be infringed by some manner, permitted by this License, of making, using, or selling its contributor version, but do not include claims that would be infringed only as a consequence of further modification of the contributor version. For purposes of this definition, "control" includes the right to grant patent sublicenses in a manner consistent with the requirements of this License.

Each contributor grants you a non-exclusive, worldwide, royalty-free patent license under the contributor's essential patent claims, to make, use, sell, offer for sale, import and otherwise run, modify and propagate the contents of its contributor version.

12.2 GNU Free Documentation License

Version 1.3, 3 November 2008

Copyright © 2000, 2001, 2002, 2007, 2008 Free Software Foundation, Inc. <<http://fsf.org/>>

Everyone is permitted to copy and distribute verbatim copies of this license document, but changing it is not allowed. 0. PREAMBLE

The purpose of this License is to make a manual, textbook, or other functional and useful document "free" in the sense of freedom: to assure everyone the effective freedom to copy and redistribute it, with or without modifying it, either commercially or noncommercially. Secondly, this License preserves for the author and publisher a way to get credit for their work, while not being considered responsible for modifications made by others.

This License is a kind of "copyleft", which means that derivative works of the document must themselves be free in the same sense. It complements the GNU General Public License, which is a copyleft license designed for free software.

We have designed this License in order to use it for manuals for free software, because free software needs free documentation: a free program should come with manuals providing the same freedoms that the software does. But this License is not limited to software manuals; it can be used for any textual work, regardless of subject matter or whether it is published as a printed book. We recommend this License principally for works whose purpose is instruction or reference. 1. APPLICABILITY AND DEFINITIONS

This License applies to any manual or other work, in any medium, that contains a notice placed by the copyright holder saying it can be distributed under the terms of this License. Such a notice grants a world-wide, royalty-free license, unlimited in duration, to use that work under the conditions stated herein. The "Document", below, refers to any such manual or work. Any member of the public is a licensee, and is addressed as "you". You accept the license if you copy, modify or distribute the work in a way requiring permission under copyright law.

A "Modified Version" of the Document means any work containing the Document or a portion of it, either copied verbatim, or with modifications and/or translated into another language.

A "Secondary Section" is a named appendix or a front-matter section of the Document that deals exclusively with the relationship of the publishers or

In the following three paragraphs, a "patent license" is any express agreement or commitment, however denominated, not to enforce a patent (such as an express permission to practice a patent or covenant not to sue for patent infringement). To "grant" such a patent license to a party means to make such an agreement or commitment not to enforce a patent against the party.

If you convey a covered work, knowingly relying on a patent license, and the Corresponding Source of the work is not available for anyone to copy, free of charge and under the terms of this License, through a publicly available network server or other readily accessible means, then you must either (1) cause the Corresponding Source to be so available, or (2) arrange to deprive yourself of the benefit of the patent license for this particular work, or (3) arrange, in a manner consistent with the requirements of this License, to extend the patent license to downstream recipients. "Knowingly relying" means you have actual knowledge that, but for the patent license, your conveying the covered work in a country, or your recipient's use of the covered work in a country, would infringe one or more identifiable patents in that country that you have reason to believe are valid.

If, pursuant to or in connection with a single transaction or arrangement, you convey, or propagate by procuring conveyance of, a covered work, and grant a patent license to some of the parties receiving the covered work authorizing them to use, propagate, modify or convey a specific copy of the covered work, then the patent license you grant is automatically extended to all recipients of the covered work and works based on it.

A patent license is "discriminatory" if it does not include within the scope of its coverage, prohibits the exercise of, or is conditioned on, the exercise of, one or more of the rights that are specifically granted under this License. You may not convey a covered work if you are a party to an arrangement with a third party that is in the business of distributing software, under which you make payment to the third party based on the extent of your activity of conveying the work, and under which the third party grants, to any of the parties who would receive the covered work from you, a discriminatory patent license (a) in connection with copies of the covered work conveyed by you (or copies made from those copies), or (b) primarily for and in connection with specific products or compilations that contain the covered work, unless you entered into that arrangement, or that patent license was granted, prior to 28 March 2007.

Nothing in this License shall be construed as excluding or limiting any implied license or other defenses to infringement that may otherwise be available to you under applicable patent law. 12. No Surrender of Others' Freedom.

If conditions are imposed on you (whether by court order, agreement or otherwise) that contradict the conditions of this License, they do not excuse you from the conditions of this License. If you cannot convey a covered work so as to satisfy simultaneously your obligations under this License and any other pertinent obligations, then as a consequence you may not convey it at all. For example, if you agree to terms that obligate you to collect a royalty for further conveying from those to whom you convey the Program, the only way you could satisfy both those terms and this License would be to refrain entirely from conveying the Program. 13. Use with the GNU Affero General Public License.

authors of the Document to the Document's overall subject (or to related matters) and contains nothing that could fall directly within that overall subject (The Document is in part a textbook of mathematics, a Secondary Section may not explain any mathematics.) The relationship could be a matter of historical connection with the subject or with related matters, or of legal, commercial, philosophical, ethical or political position regarding them.

The "Invariant Sections" are certain Secondary Sections whose titles are designated, as being those of Invariant Sections, in the notice that says that the Document is released under this License. If a section does not fit the above definition of Secondary then it is not allowed to be designated as Invariant. The Document may contain zero or more Invariant Sections. If the Document does not identify any Invariant Sections then there are none.

The "Cover Texts" are certain short passages of text that are listed, as Front-Cover Texts or Back-Cover Texts, in the notice that says that the Document is released under this License. A Front-Cover Text may be at most 5 words, and a Back-Cover Text may be at most 25 words.

A "Transparent" copy of the Document means a machine-readable copy, represented in a format whose specification is available to the general public, that is suitable for revising the document straightforwardly with generic text editors or (for images composed of pixels) generic paint programs or (for drawings) some widely available drawing editor, and that is suitable for input to text formatters or for automatic translation to a variety of formats suitable for input to text formatters. A copy made in an otherwise Transparent file format whose markup, or absence of markup, has been arranged to thwart or discourage subsequent modification by readers is not Transparent. An image format is not Transparent if used for any substantial amount of text. A copy that is not "Transparent" is called "Opaque".

Examples of suitable formats for Transparent copies include plain ASCII without markup, Texinfo input format, LaTeX input format, SGML or XML using a publicly available DTD, and standard-conforming simple HTML, PostScript or PDF designed for human modification. Examples of transparent image formats include PNG, XCF and JPG. Opaque formats include proprietary formats that can be read and edited only by proprietary word processors, SGML or XML for which the DTD and/or processing tools are not generally available, and the machine-generated HTML, PostScript or

Notwithstanding any other provision of this License, you have permission to link or combine any covered work with a work licensed under version 3 of the GNU Affero General Public License into a single combined work, and to convey the resulting work. The terms of this License will continue to apply to the part which is the covered work, but the special requirements of the GNU Affero General Public License, section 13, concerning interaction through a network will apply to the combination as such. 14. Revised Versions of this License.

The Free Software Foundation may publish revised and/or new versions of the GNU General Public License from time to time. Such new versions will be similar in spirit to the present version, but may differ in detail to address new problems or concerns.

Each version is given a distinguishing version number. If the Program specifies that a certain numbered version of the GNU General Public License "or any later version" applies to it, you have the option of following the terms and conditions either of that numbered version or of any later version published by the Free Software Foundation. If the Program does not specify a version number of the GNU General Public License, you may choose any version ever published by the Free Software Foundation.

If the Program specifies that a proxy can decide which future versions of the GNU General Public License can be used, that proxy's public statement of acceptance of a version permanently authorizes you to choose that version for the Program.

Later license versions may give you additional or different permissions. However, no additional obligations are imposed on any author or copyright holder as a result of your choosing to follow a later version. 15. Disclaimer of Warranty.

THERE IS NO WARRANTY FOR THE PROGRAM, TO THE EXTENT PERMITTED BY APPLICABLE LAW. EXCEPT WHEN OTHERWISE STATED IN WRITING THE COPYRIGHT HOLDERS AND/OR OTHER PARTIES PROVIDE THE PROGRAM "AS IS" WITHOUT WARRANTY OF ANY KIND, EITHER EXPRESSED OR IMPLIED, INCLUDING, BUT NOT LIMITED TO, THE IMPLIED WARRANTIES OF MERCHANTABILITY AND FITNESS FOR A PARTICULAR PURPOSE. THE ENTIRE RISK AS TO THE QUALITY AND PERFORMANCE OF THE PROGRAM IS WITH YOU. SHOULD THE PROGRAM PROVE DEFECTIVE, YOU ASSUME THE COST OF ALL NECESSARY SERVICING, REPAIR OR CORRECTION. 16. Limitation of Liability.

IN NO EVENT UNLESS REQUIRED BY APPLICABLE LAW OR AGREED TO IN WRITING WILL ANY COPYRIGHT HOLDER, OR ANY OTHER PARTY WHO MODIFIES AND/OR CONVEYS THE PROGRAM AS PERMITTED ABOVE, BE LIABLE TO YOU FOR DAMAGES, INCLUDING ANY GENERAL, SPECIAL, INCIDENTAL OR CONSEQUENTIAL DAMAGES ARISING OUT OF THE USE OR INABILITY TO USE THE PROGRAM (INCLUDING BUT NOT LIMITED TO LOSS OF DATA OR DATA BEING RENDERED INACCURATE OR LOSSES SUSTAINED BY YOU OR THIRD PARTIES OR A FAILURE OF THE PROGRAM TO OPERATE WITH ANY OTHER PROGRAMS), EVEN IF SUCH HOLDER OR OTHER PARTY HAS BEEN ADVISED OF THE POSSIBILITY OF SUCH DAMAGES. 17. Interpretation of Sections 15 and 16.

If the disclaimer of warranty and limitation of liability provided above cannot be given local legal ef-

fect according to their terms, reviewing courts shall apply local law that most closely approximates an absolute waiver of all civil liability in connection with the Program, unless a warranty or assumption of liability accompanies a copy of the Program in return for a fee.

END OF TERMS AND CONDITIONS How to Apply These Terms to Your New Programs

If you develop a new program, and you want it to be of the greatest possible use to the public, the best way to achieve this is to make it free software which everyone can redistribute and change under these terms.

To do so, attach the following notices to the program. It is safest to attach them to the start of each source file to most effectively state the exclusion of warranty; and each file should have at least the "copyright" line and a pointer to where the full notice is found.

```
<one line to give the program's name and a brief idea of what it does.> Copyright (C) <year>
<name of author>
```

This program is free software; you can redistribute it and/or modify it under the terms of the GNU General Public License as published by the Free Software Foundation, either version 3 of the License, or (at your option) any later version.

This program is distributed in the hope that it will be useful, but WITHOUT ANY WARRANTY; without even the implied warranty of MERCHANTABILITY or FITNESS FOR A PARTICULAR PURPOSE. See the GNU General Public License for more details.

You should have received a copy of the GNU General Public License along with this program. If not, see <<http://www.gnu.org/licenses/>>.

Also add information on how to contact you by electronic and paper mail.

If the program does terminal interaction, make it output a short notice like this when it starts in an interactive mode:

```
<program> Copyright (C) <year> <name of author>
This program comes with ABSOLUTELY NO WARRANTY; for details type 'show w'. This is free software, and you are welcome to redistribute it under certain conditions; type 'show c' for details.
```

The hypothetical commands 'show w' and 'show c' should show the appropriate parts of the General Public License. Of course, your program's commands might be different; for a GUI interface, you would use an "about box".

You should also get your employer (if you work as a programmer) or school, if any, to sign a "copyright disclaimer" for the program, if necessary. For more information on this, and how to apply and follow the GNU GPL, see <<http://www.gnu.org/licenses/>>.

The GNU General Public License does not permit incorporating your program into proprietary programs. If your program is a subroutine library, you may consider it more useful to permit linking proprietary applications with the library. If this is what you want to do, use the GNU Lesser General Public License instead of this License. But first, please read <<http://www.gnu.org/philosophy/why-not-lgpl.html>>.

PDF produced by some word processors for output purposes only.

The "Title Page" means, for a printed book, the title page itself, plus such following pages as are needed to hold, legibly, the material this License requires to appear in the title page. For works in formats which do not have any title page as such, "Title Page" means the text near the most prominent appearance of the work's title, preceding the beginning of the body of the text.

The "publisher" means any person or entity that distributes copies of the Document to the public.

A section "Entitled XYZ" means a named subunit of the Document whose title either is precisely XYZ or contains XYZ in parentheses following text that translates XYZ in another language. (Here XYZ stands for a specific section name mentioned below, such as "Acknowledgements", "Dedications", "Endorsements", or "History".) To "Preserve the Title" of such a section when you modify the Document means that it remains a section "Entitled XYZ" according to this definition.

The Document may include Warranty Disclaimers next to the notice which states that this License applies to the Document. These Warranty Disclaimers are considered to be included by reference in this License, but only as regards disclaiming warranties; any other implication that these Warranty Disclaimers may have is void and has no effect on the meaning of this License. 2. VERBATIM COPYING

You may copy and distribute the Document in any medium, either commercially or noncommercially, provided that this License, the copyright notices, and the license notice saying this License applies to the Document are reproduced in all copies, and that you add no other conditions whatsoever to those of this License. You may not use technical measures to obstruct or control the reading or further copying of the copies you make or distribute. However, you may accept compensation in exchange for copies. If you distribute a large enough number of copies you must also follow the conditions in section 3.

You may also lend copies, under the same conditions stated above, and you may publicly display copies. 3. COPYING IN QUANTITY

If you publish printed copies (or copies in media that commonly have printed covers) of the Document, numbering more than 100, and the Document's license notice requires Cover Texts, you

must enclose the copies in covers that carry, clearly and legibly, all these Cover Texts: Front-Cover Texts on the front cover, and Back-Cover Texts on the back cover. Both covers must also clearly and legibly identify you as the publisher of these copies. The front cover must present the full title with all words of the title equally prominent and visible. You may add other material on the covers in addition. Copying with changes limited to the covers, as long as they preserve the title of the Document and satisfy these conditions, can be treated as verbatim copying in other respects.

If the required texts for either cover are too voluminous to fit legibly, you should put the first ones listed (as many as fit reasonably) on the actual cover, and continue the rest onto adjacent pages.

If you publish or distribute Opaque copies of the Document numbering more than 100, you must either include a machine-readable Transparent copy along with each Opaque copy, or state in or with each Opaque copy a computer-network location from which the general network-using public has access to download using public-standard network protocols a complete Transparent copy of the Document, free of added material. If you use the latter option, you must take reasonably prudent steps, when you begin distribution of Opaque copies in quantity, to ensure that this Transparent copy will remain thus accessible at the stated location until at least one year after the last time you distribute an Opaque copy (directly or through your agents or retailers) of that edition of the public.

It is requested, but not required, that you contact the authors of the Document well before redistributing any large number of copies, to give them a chance to provide you with an updated version of the Document. 4. MODIFICATIONS

You may copy and distribute a Modified Version of the Document under the conditions of sections 2 and 3 above, provided that you release the Modified Version under precisely this License, with the Modified Version filling the role of the Document, thus licensing distribution and modification of the Modified Version to whoever possesses a copy of it. In addition, you must do these things in the Modified Version:

* A. Use in the Title Page (and on the covers, if any) a title distinct from that of the Document, and from those of previous versions (which should, if there were any, be listed in the History section of the Document). You may use the same title as a previous version if the original publisher of that version gives permission. * B. List on the Title

Page, as authors, one or more persons or entities responsible for authorship of the modifications in the Modified Version, together with at least five of the principal authors of the Document (all of its principal authors, if it has fewer than five), unless they release you from this requirement. * C. State on the Title page the name of the publisher of the Modified Version, as the publisher. * D. Preserve all the copyright notices of the Document. * E. Add an appropriate copyright notice for your modifications adjacent to the other copyright notices. * F. Include, immediately after the copyright notices, a license notice giving the public permission to use the Modified Version under the terms of this License, in the form shown in the Addendum below. * G. Preserve in that license notice the full lists of Invariant Sections and required Cover Texts given in the Document's license notice. * H. Include an unaltered copy of this License. * I. Preserve the section Entitled "History". Preserve its Title, and add to it an item stating at least the title, year, new authors, and publisher of the Modified Version as given on the Title Page. If there is no section Entitled "History" in the Document, create one stating the title, year, authors, and publisher of the Document as given on its Title Page, then add an item describing the Modified Version as stated in the previous sentence. * J. Preserve the network location, if any, given in the Document for public access to a Transparent copy of the Document, and likewise the network locations given in the Document for previous versions it was based on. These may be placed in the "History" section. You may omit a network location for a work that was published at least four years before the Document itself, or if the original publisher of the version it refers to gives permission. * K. For any section Entitled "Acknowledgements" or "Dedications", Preserve the Title of the section, and preserve in the section all the substance and tone of each of the contributor acknowledgements and/or dedications given therein. * L. Preserve all the Invariant Sections of the Document, unaltered in their text and in their titles. Section numbers or the equivalent are not considered part of the section titles. * M. Delete any section Entitled "Endorsements". Such a section may not be included in the Modified Version. * N. Do not retile any existing section to be Entitled "Endorsements" or to conflict in title with any Invariant Section. * O. Preserve any Warranty Disclaimers.

If the Modified Version includes new front-matter sections or appendices that qualify as Secondary Sections and contain no material copied from the Document, you may at your option designate some or all of these sections as invariant. To do this, add their titles to the list of Invariant Sections in the Modified Version's license notice. These titles must be distinct from any other section titles.

You may add a section Entitled "Endorsements", provided it contains nothing but endorsements of your Modified Version by various parties—for example, statements of peer review or that the text has been approved by an organization as the authoritative definition of a standard.

You may add a passage of up to five words as a Front-Cover Text, and a passage of up to 25 words as a Back-Cover Text, to the end of the list of Cover Texts in the Modified Version. Only one passage of Front-Cover Text and one of Back-Cover Text may be added by (or through arrangements made by) any one entity. If the Document already includes a cover text for the same cover, previously added by you or by arrangement made by the same entity you are acting on behalf of, you may not add an-

other; but you may replace the old one, on explicit permission from the previous publisher that added the old one.

The author(s) and publisher(s) of the Document do not by this License give permission to use their names for publicity for or to assert or imply endorsement of any Modified Version. 5. COMBINING DOCUMENTS

You may combine the Document with other documents released under this License, under the terms defined in section 4 above for modified versions, provided that you include in the combination all of the Invariant Sections of all of the original documents, unmodified, and list them all as Invariant Sections of your combined work in its license notice, and that you preserve all their Warranty Disclaimers.

The combined work need only contain one copy of this License, and multiple identical Invariant Sections may be replaced with a single copy. If there are multiple Invariant Sections with the same name but different contents, make the title of each such section unique by adding at the end of it, in parentheses, the name of the original author or publisher of that section if known, or else a unique number. Make the same adjustment to the section titles in the list of Invariant Sections in the license notice of the combined work.

In the combination, you must combine any sections Entitled "History" in the various original documents, forming one section Entitled "History"; likewise combine any sections Entitled "Acknowledgements", and any sections Entitled "Dedications". You must delete all sections Entitled "Endorsements". 6. COLLECTIONS OF DOCUMENTS

You may make a collection consisting of the Document and other documents released under this License, and replace the individual copies of this License in the various documents with a single copy that is included in the collection, provided that you follow the rules of this License for verbatim copying of each of the documents in all other respects.

You may extract a single document from such a collection, and distribute it individually under this License, provided you insert a copy of this License into the extracted document, and follow this License in all other respects regarding verbatim copying of that document. 7. AGGREGATION WITH INDEPENDENT WORKS

A compilation of the Document or its derivatives with other separate and independent documents or works, in or on a volume of a storage or distribution medium, is called an "aggregate" if the copyright resulting from the compilation is not used to limit the legal rights of the compilation's users beyond what the individual works permit. When the Document is included in an aggregate, this License does not apply to the other works in the aggregate which are not themselves derivative works of the Document.

If the Cover Text requirement of section 3 is applicable to these copies of the Document, then if the Document is less than one half of the entire aggregate, the Document's Cover Texts may be placed on covers that bracket the Document within the aggregate, or the electronic equivalent of covers if the Document is in electronic form. Otherwise they must appear on printed covers that bracket the whole aggregate. 8. TRANSLATION

Translation is considered a kind of modification, so you may distribute translations of the Document under the terms of section 4. Replacing Invariant Sections with translations requires special permission from their copyright holders, but you may include translations of some or all Invariant Sections in addition to the original versions of these Invariant Sections. You may include a translation of this License, and all the license notices in the Document, and any Warranty Disclaimers, provided that you also include the original English version of this License and the original versions of those notices and disclaimers. In case of a disagreement between the translation and the original version of this License or a notice or disclaimer, the original version will prevail.

If a section in the Document is Entitled "Acknowledgements", "Dedications", or "History", the requirement (section 4) to Preserve its Title (section 1) will typically require changing the actual title. 9. TERMINATION

You may not copy, modify, sublicense, or distribute the Document except as expressly provided under this License. Any attempt otherwise to copy, modify, sublicense, or distribute it is void, and will automatically terminate your rights under this License.

However, if you cease all violation of this License, then your license from a particular copyright holder is reinstated (a) provisionally, unless and until the copyright holder explicitly and finally terminates your license, and (b) permanently, if the copyright holder fails to notify you of the violation by some reasonable means prior to 60 days after the cessation.

Moreover, your license from a particular copyright holder is reinstated permanently if the copyright holder notifies you of the violation by some reasonable means, this is the first time you have received notice of violation of this License (for any work) from that copyright holder, and you cure the violation prior to 30 days after your receipt of the notice.

Termination of your rights under this section does not terminate the licenses of parties who have received copies or rights from you under this License. If your rights have been terminated and not permanently reinstated, receipt of a copy of some or all of the same material does not give you any rights to use it. 10. FUTURE REVISIONS OF THIS LICENSE

The Free Software Foundation may publish new, revised versions of the GNU Free Documentation License from time to time. Such new versions will be similar in spirit to the present version, but may differ in detail to address new problems or concerns. See <http://www.gnu.org/copyleft/>.

Each version of the License is given a distinguishing version number. If the Document specifies that a particular numbered version of this License "or any later version" applies to it, you have the option of following the terms and conditions either of that specified version or of any later version that has been published (not as a draft) by the Free Software Foundation. If the Document does not specify a version number of this License, you may choose any version ever published (not as a draft) by the Free Software Foundation. If the Document specifies that a proxy can decide which future versions of

this License can be used, that proxy's public statement of acceptance of a version permanently authorizes you to choose that version for the Document. 11. RELICENSING

"Massive Multiauthor Collaboration Site" (or "MMC Site") means any World Wide Web server that publishes copyrightable works and also provides prominent facilities for anybody to edit those works. A public wiki that anybody can edit is an example of such a server. A "Massive Multiauthor Collaboration" (or "MMC") contained in the site means any set of copyrightable works thus published on the MMC site.

"CC-BY-SA" means the Creative Commons Attribution-Share Alike 3.0 license published by Creative Commons Corporation, a not-for-profit corporation with a principal place of business in San Francisco, California, as well as future copyleft versions of that license published by that same organization.

"Incorporate" means to publish or republish a Document, in whole or in part, as part of another Document.

An MMC is "eligible for relicensing" if it is licensed under this License, and if all works that were first published under this License somewhere other than this MMC, and subsequently incorporated in whole or in part into the MMC, (1) had no cover texts or invariant sections, and (2) were thus incorporated prior to November 1, 2008.

The operator of an MMC Site may republish an MMC contained in the site under CC-BY-SA on the same site at any time before August 1, 2009, provided the MMC is eligible for relicensing. ADDENDUM: How to use this License for your documents

To use this License in a document you have written, include a copy of the License in the document and put the following copyright and license notices just after the title page:

Copyright (C) YEAR YOUR NAME. Permission is granted to copy, distribute and/or modify this document under the terms of the GNU Free Documentation License, Version 1.3 or any later version published by the Free Software Foundation; with no Invariant Sections, no Front-Cover Texts, and no Back-Cover Texts. A copy of the license is included in the section entitled "GNU Free Documentation License".

If you have Invariant Sections, Front-Cover Texts and Back-Cover Texts, replace the "with ... Texts." line with this:

with the Invariant Sections being LIST THEIR TITLES, with the Front-Cover Texts being LIST, and with the Back-Cover Texts being LIST.

If you have Invariant Sections without Cover Texts, or some other combination of the three, merge those two alternatives to suit the situation.

If your document contains nontrivial examples of program code, we recommend releasing these examples in parallel under your choice of free software license, such as the GNU General Public License, to permit their use in free software.

12.3 GNU Lesser General Public License

GNU LESSER GENERAL PUBLIC LICENSE

Version 3, 29 June 2007

Copyright © 2007 Free Software Foundation, Inc. <<http://fsf.org/>>

Everyone is permitted to copy and distribute verbatim copies of this license document, but changing it is not allowed.

This version of the GNU Lesser General Public License incorporates the terms and conditions of version 3 of the GNU General Public License, supplemented by the additional permissions listed below. 0. Additional Definitions.

As used herein, "this License" refers to version 3 of the GNU Lesser General Public License, and the "GNU GPL" refers to version 3 of the GNU General Public License.

"The Library" refers to a covered work governed by this License, other than an Application or a Combined Work as defined below.

An "Application" is any work that makes use of an interface provided by the Library, but which is not otherwise based on the Library. Defining a subclass of a class defined by the Library is deemed a mode of using an interface provided by the Library.

A "Combined Work" is a work produced by combining or linking an Application with the Library. The particular version of the Library with which the Combined Work was made is also called the "Linked Version".

The "Minimal Corresponding Source" for a Combined Work means the Corresponding Source for the Combined Work, excluding any source code for portions of the Combined Work that, considered in isolation, are based on the Application, and not on the Linked Version.

The "Corresponding Application Code" for a Combined Work means the object code and/or source code for the Application, including any data and utility programs needed for reproducing the Combined Work from the Application, but excluding the System Libraries of the Combined Work. 1. Exception to Section 3 of the GNU GPL.

You may convey a covered work under sections 3 and 4 of this License without being bound by section 3 of the GNU GPL. 2. Conveying Modified Versions.

If you modify a copy of the Library, and, in your modifications, a facility refers to a function or data to be supplied by an Application that uses the facility (other than as an argument passed when the facility is invoked), then you may convey a copy of the modified version:

* a) under this License, provided that you make a good faith effort to ensure that, in the event an Application does not supply the function or data, the facility still operates, and performs whatever part of its purpose remains meaningful, or * b) under the GNU GPL, with none of the additional permissions of this License applicable to that copy.

3. Object Code Incorporating Material from Library Header Files.

The object code form of an Application may incorporate material from a header file that is part of the Library. You may convey such object code under terms of your choice, provided that, if the incorporated material is not limited to numerical parameters, data structure layouts and accessors, or small macros, inline functions and templates (ten or fewer lines in length), you do both of the following:

* a) Give prominent notice with each copy of the object code that the Library is used in it and that the Library and its use are covered by this License. * b) Accompany the object code with a copy of the GNU GPL and this license document.

4. Combined Works.

You may convey a Combined Work under terms of your choice that, taken together, effectively do not restrict modification of the portions of the Library contained in the Combined Work and reverse engineering for debugging such modifications, if you also do each of the following:

* a) Give prominent notice with each copy of the Combined Work that the Library is used in it and that the Library and its use are covered by this License. * b) Accompany the Combined Work with a copy of the GNU GPL and this license document. * c) For a Combined Work that displays copyright notices during execution, include the copyright notice for the Library among these notices, as well as a reference directing the user to the copies of the GNU GPL and this license document. * d) Do one of the following: o 0) Convey the Minimal Corresponding Source under the terms of this License, and the Corresponding Application Code in a form suitable for, and under terms that permit, the user to recombine or relink the Application with a modified version of the Linked Version to produce a modified Combined Work, in the manner specified by section 6 of the GNU GPL for conveying Corresponding Source. o 1) Use a suitable shared library mechanism for linking with the Library. A suitable mechanism is one that (a) uses at run time a copy of the Library already present on the user's computer system, and (b) will operate properly with a modified version of the Library that is interface-compatible with the Linked Version. * e) Provide Installation Information, but only if you would otherwise be required to provide such information under section 6 of the GNU GPL, and only to the extent that such information is necessary to install and execute a modified version of the Combined Work produced by recombining or relinking the Application with a modified version of the Linked Version. (If you use option 4d, the Installation Information must accompany the Minimal Corresponding Source and Corresponding Application Code. If you use option 4e, you must provide the Installation Information in the manner specified by section 6 of the GNU GPL for conveying Corresponding Source.)

5. Combined Libraries.

You may place library facilities that are a work based on the Library side by side in a single library together with other library facilities that are not Applications and are not covered by this License, and convey such a combined library under terms of your choice, if you do both of the following:

* a) Accompany the combined library with a copy of the same work based on the Library, uncombined with any other library facilities, conveyed under the terms of this License. * b) Give prominent notice with the combined library that part of it is a work based on the Library, and explaining where to find the accompanying uncombined form of the same work.

6. Revised Versions of the GNU Lesser General Public License.

The Free Software Foundation may publish revised and/or new versions of the GNU Lesser General Public License from time to time. Such new versions will be similar in spirit to the present version, but may differ in detail to address new problems or concerns.

Each version is given a distinguishing version number. If the Library as you received it specifies that a certain numbered version of the GNU Lesser General Public License "or any later version" applies to it, you have the option of following the terms and conditions either of that published version or of any later version published by the Free Software Foundation. If the Library as you received it does not specify a version number of the GNU Lesser General Public License, you may choose any version of the GNU Lesser General Public License ever published by the Free Software Foundation.

If the Library as you received it specifies that a proxy can decide whether future versions of the GNU Lesser General Public License shall apply, that proxy's public statement of acceptance of any version is permanent authorization for you to choose that version for the Library.