



TEST 1

SECTION 1 Questions 1-10

Questions 1-7

Complete the notes below.

Write **ONE WORD AND/OR A NUMBER** for each answer.

Harper Holiday Job Agency

Application for Temporary Work

Personal Details

First Name: Lily

Surname: 1

Date of birth: 2

Temporary Work Requirements

Period when work wanted from June to 3

Where work wanted: 4 or 5

Type of work wanted:

1st priority: 6 work

2nd priority: 7 work

Questions 8-10

Choose **THREE** letters, A-G.

Which of these has Lily got?

- A a good knowledge of a foreign language
- B a driving license
- C the ability to deal with the public
- D a sports coaching qualification
- E good computer skills
- F experience of working with young children
- G the ability to play a musical instrument

SECTION 2 Questions 11-20

Questions 11-15

Choose **FIVE** answers from the box and write the correct letter, A-G, next to questions 11-15.

Community Centre Facilities

Football pitches 11

Library 12

Tennis courts 13

Large hall 14

Computer lab 15

- A deposit is required
- B only available at weekends
- C can be reserved online
- D currently under repair
- E recently extended
- F temporarily not available
- G no booking is necessary

Questions 16-20

Complete the notes below.

Write **NO MORE THAN TWO WORDS AND/OR A NUMBER** for each answer.

Date: Oct. 14th

Event: **16** competition

Entrants: **17**

Type of prize: **18**

Cost of ticket per person: \$1.50

Date: Starts on **19**

Event: Photography exhibition

Entrants: **20**

Type of prize: DVDs

Cost of ticket per person: \$2.00

SECTION 3 Questions 21-30

Questions 21-25

Choose the correct letter, **A, B** or **C**.

21 Martin and Julia agree that the most difficult part about working together is

- A** dividing the reading up equally
- B** finding a mutually convenient time to meet
- C** ensuring all sections of the presentation link together

22 What does Martin think is important to remember when they deliver the presentation?

- A** to provide sufficient detail
- B** to consider the kind of audience they have
- C** to avoid going over the time limit

23 Which aspect of biomechanics is Martin keen to research further?

- A** the analysis of human movement
- B** the influence of the environment
- C** the role of sports equipment

24 According to Julia, sports science is of most benefit to athletes when

- A** it enables them to perform consistently
- B** it identifies an athlete's readiness for competition
- C** it assesses the effectiveness of a training programme

25 What does Julia say about the psychology of athletes?

- A** They are particularly strong-willed
- B** They become over-confident when winning.
- C** They depend too much on professional support



Questions 26-30

Which methods will be used to satisfy the criteria on the following checklist?

Choose **FIVE** answers from the box and write the correct letter, **A-G**, next to questions 26-30.

Checklist

- Are the main points understood? **26**
- Are the technical words clearly explained? **27**
- Is audience interest maintained? **28**
- Is technology used effectively? **29**
- Is the time managed well? **30**

Methods

- A** handout **E** self-monitoring
- B** a preliminary trial **G** illustrations
- C** a short break
- D** discussion tasks
- E** questions

SECTION 4 Questions 31-40

Write **NO MORE THAN TWO WORDS** for each answer

Tropical ecosystems: North Queensland

Focus of lecture

- type of landscape: **31**.....
- Effect of storms on certain wildlife species

Damage to ecosystems

- Most damaged areas lie between **32** and urban development (because unprotected from floods etc)
- Plants are most damaged when located near **33**

Effects of recent cyclone

- Marsupial numbers remained stable
- One **34** species altered its sleeping habits
- All species of fruit eating birds recovered, except the cassowary.
- Cassowaries wandered onto roads in sear of **35**
- Many died as a result of road vehicles and **36**
- When disturbed in their natural habitat cassowaries become more prone to **37**

Cassowary conservation

A group of biologists is

- monitoring typical cassowary movements
- providing so-called **38** for cassowaries to move around safely

Plans for the future

- Funding has been obtained from a **39**
- Need to determine exact numbers of cassowaries
- The first protected areas is on the **40**



TEST 2

SECTION 1 Questions 1-10

Questions 1-3

Choose **THREE** letters **B-H**

Which **THREE** other activities does the customer want to do?

- | | | | |
|---------|--------------------------|--------------------------------|------------------------------|
| Example | A visit family | D study English | G join a walking tour |
| | B save money | E do some winter sports | H meet young people |
| | C study geography | F go sailing | |

Questions 4-7

Complete the form below.

Write **NO MORE THAN THREE WORDS AND/OR A NUMBER** for each answer.

CUSTOMER'S DETAILS

Name	Su Ming Lee
Address	4 Kew
Mobile	5 0402.....
Day and date of departure	6
Length of course	7
Method of payment	credit card

Questions 8-10

Label the map opposite.

Write the correct letter **A-G** next to questions 8-10.

- 8 The language school is at
- 9 The hotel is at
- 10 The bookshop is at

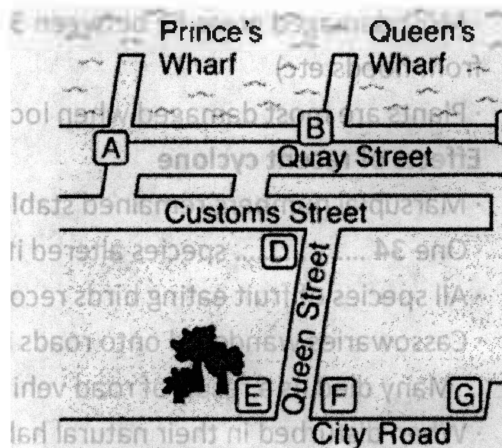

SECTION 2 Questions 11-20

Questions 11-13

Complete the sentences below.

Write **NO MORE THAN THREE WORDS** for each answer.

- 11 are often known by their famous bridges
- 12 The speaker compares a bridge to a cathedral or
- 13 Sydney Harbor Bridge is nicknamed

Question 11-18

Complete the notes below.

Write **NO MORE THAN THREE WORDS AND/OR A NUMBER** for each answer.



Date	Event
1916	14 Agreed to finance bridge
15	Contract signed with engineering firm
1926	Construction involved: <ul style="list-style-type: none"> • knocking down 16 • creation of many jobs
1932	Bridge completed at a cost of 17 £
March 1932	Opening ceremony Ribbon cut by a man riding a 18

Questions 19-20

Answer the questions below.

Write **NO MORE THAN THREE WORDS AND/OR A NUMBER** for each answer.

19 How long is the tunnel?

20 Name ONE thing the tunnel can withstand.

SECTION 3 Questions 21-30

Question 21

Choose the correct letter A, B or C.

21 Which graph shows the distribution of animals painted on the caves?

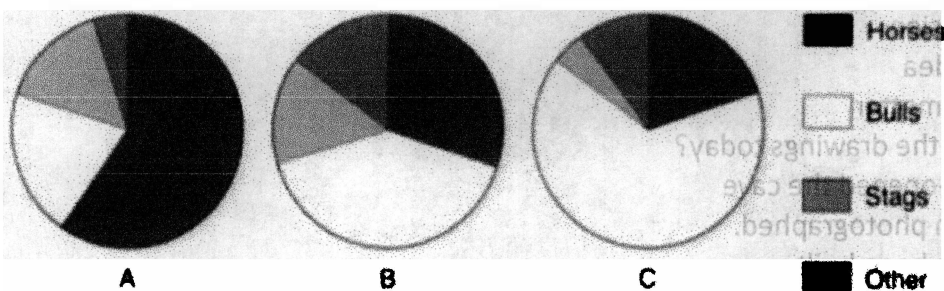

Questions 22-25

How does the woman describe each type of drawing?

Choose your own answers from the box and write the letters A-H next to questions 22-25.

22 bulls

23 humans

24 signs

25 fish

- | | | |
|-------------|----------------------|-------------------|
| A uncommon | B realistic | C two-dimensional |
| D childish | E consisting of dots | F complex |
| G important | H huge | |

Questions 26-27

Label the diagram below.

Write **NO MORE THAN THREE WORDS** for each answer.

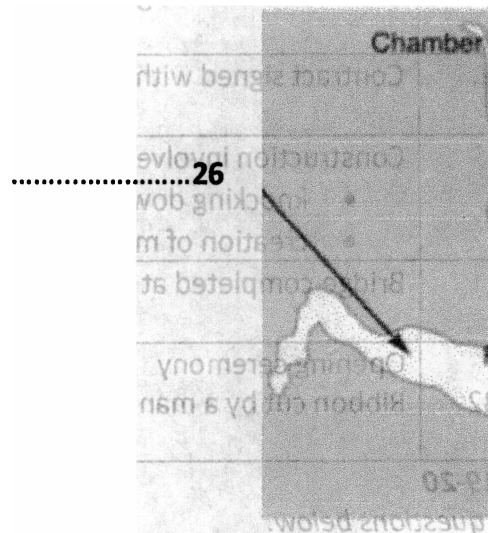
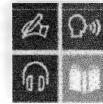

Questions 28-30

Choose the correct letter **A**, **B** or **C**.

28 The cave was closed in 1963 because

- A** the tourists had drawn pictures on the walls
- B** the air was harming the rock art
- C** so few people were visiting the site

29 How does David feel about the closure of the cave?

- A** He agrees with the decision
- B** He thinks it was a bad idea
- C** He has no views on the matter

30 How can people enjoy the drawings today?

- A** The government has re-opened the cave
- B** The drawings have been photographed.
- C** A replica of the cave has been built.

SECTION 4 Questions 31-40

Questions 31-32

Complete the notes below.

Write **NO MORE THAN THREE WORDS** for each answer.

What is marketing?

31 and represent only two aspects of marketing.

Marketing involves:

- finding customers
- ensuring customers satisfaction
- **32**

Questions 33-34

Complete the flow-chart below.

Write **NO MORE THAN TWO WORDS** for each answer.

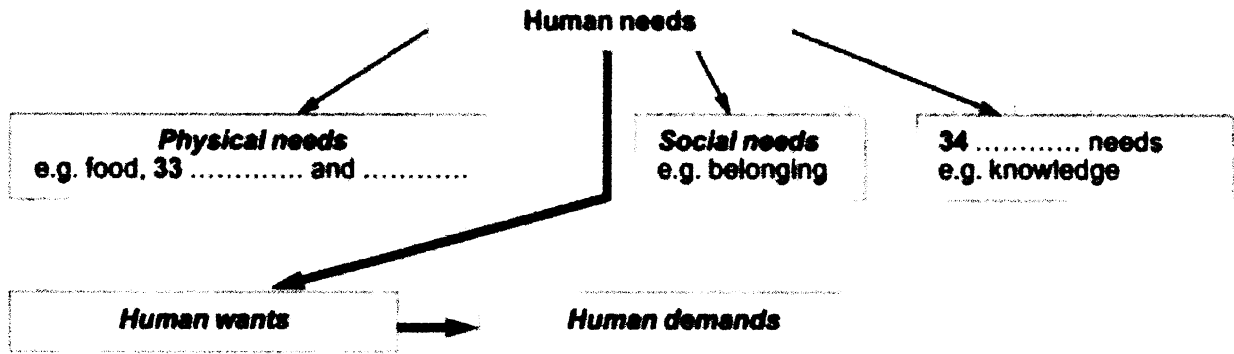

Questions 35-38

Which market research method is used by each of these businesses?

Write the correct letter A-C next to questions 35-38.

- | | | |
|------------------------|------------------------|-------|
| A customer observation | 35 supermarkets | |
| B free offers | 36 department stores | |
| C in-store surveys | 37 fast-food companies | |
| | 38 theme-parks | |

Questions 39-40

Complete the notes below.

Write **NO MORE THAN THREE WORDS** for each answer.

Customer satisfaction

Product Performance	Customers are
Poor	Unhappy
Good	39
40	Delighted

TEST 3

SECTION 1 Questions 1-10

Questions 1 and 2

Choose the correct letter, **A**, **B** or **C**.

Example

Penny's interview took place

- A yesterday.
- B last week.
- C two weeks ago.

1 What kind of shop is it?

- A a ladies' dress shop
- B a department store
- C a children's clothes shop

2 What is the name of the section Penny will be working in?

- A the Youngster
- B the Youngset
- C the Young Set

Questions 3-10

Complete the notes below.

Write **NO MORE THAN TWO WORDS AND/OR A NUMBER** for each answer.

- Pay:** \$6.50 an hour
- Breaks:** one hour for lunch and 3..... coffee breaks
- Holidays:** three weeks a year in the first two years
four weeks a year in the 4.....
- Staff training:** held on the 5..... of every month
- Special staff benefits or "perks":** staff discount of 6..... on everything except sale goods
- Information on pension:** see Personnel Manager, office in 7.....
- Boss's name:** 8.....
- Duties:** serve customers
9.....
check for shoplifters
check the stock
- Expected to wear:** a 10....., a red blouse,
And a name badge

SECTION 2 Questions 11-20

Questions 11-13

Choose the correct letter, A, B or C.

- 11** The Bridge Hotel is located in
A the city centre.
B the country.
C the suburbs.
- 12** The newest sports facility in the hotel is
A a swimming pool.
B a fitness centre.
C a tennis court.
- 13** The hotel restaurant specializes in
A healthy food.
B local food.
C international food.

Questions 14 and 15

Choose TWO letters, A-E.

Which **TWO** business facilities are mentioned?

- A** internet access
- B** mobile phone hire
- C** audio-visual facilities
- D** airport transport
- E** translation services

Questions 16-20

Complete the table below.

Write **NO MORE THAN THREE WORDS AND/OR A NUMBER** for each answer.

SHORT BREAK PACKAGES		
Length of stay	Cost (per person per night)	Special features
2 days	16 £	Full cooked breakfast Entertainment in the 17
3 days	£60	As above, plus: - a 18
5 days	19 £	As above, plus: - 2 days' free beauty therapy - Full-day membership of a 20

SECTION 3 Questions 21-30

Questions 21 and 22

Complete the sentences below.

Write **NO MORE THAN TWO WORDS** for each answer.

Research Project

- Harry and Katy have to concentrate on coastal change for their next project.
- 21 Their work could be delayed by the
- They plan to get help from the Marine Biology Unit.
- 22 Before they go to the beach, they need to visit the

Questions 23-26

Who will do each of the following tasks?

- A Katy
- B Harry
- C Both Katy and Harry

Write the correct letter, A, B or C, next to questions 23-26.

Tasks

- 23 take photographs
- 24 collect samples
- 25 interview people
- 26 analyse data

Questions 27-30

Choose the correct letter, A, B or C.

- 27 Why does Harry want to do the presentation?
 - A to practice skills for his future career
 - B to catch up with his course requirements
 - C to get a better mark than for his last presentation
- 28 What is Katy's attitude to writing up the project?
 - A She is worried about the time available for writing.

- B She thinks it is unfair if she has to do all the writing.
 C She is concerned that some parts will be difficult.
- 29 Why does Harry want to involve the other students at the end of the presentation?
 A to get their opinions about the conclusions
 B to help him and Katy reach firm conclusions
 C to see if they have reached similar conclusions
- 30 Katy agrees to deal with any questions because
 A she feels she will be confident about the material.
 B Harry will be doing the main presentation.
 C she has already told Dr. Smith she will do this.

SECTION 4 Questions 31-40

Questions 31-33

Complete the sentences below.

Write **NO MORE THAN THREE WORDS** for each answer.

Peregrine Falcons

- 31 The Peregrine falcons in are not migratory birds.
 32 There is disagreement about their maximum
 33 When the female is guarding the nest, the male spends most of his time

Questions 34-37

Complete the table below.

Write **NO MORE THAN THREE WORDS** for each answer.

Age of falcons	What occurs
20 days old	The falcons 34.....
28 days old	The falcons are 35.....
2 months old	The falcons 36..... permanently
1-12 months old	More than half of falcons 37.....

Questions 38-40

Complete the notes below.

Write **NO MORE THAN THREE WORDS** for each answer.

Procedures used for field research on Peregrine falcon chicks

- First: catch chicks
 Second: 38..... to legs
 Third: 39..... of chicks
 Fourth: take blood sample to assess level of pesticide
 Fifth: check the 40..... of the birds



TEST 4

SECTION 1 Questions 1-10

Questions 1-10

Complete the form below.

Write ONE WORD AND/OR A NUMBER for each answer.

THEATRE ROYAL PLYMOUTH	
Booking Form	
<i>Example</i>	
Performance:	The <i>Impostor</i>
Date:	Saturday 1.....
Time:	2.....
Tickets:	three adults and one child
Seats in:	the 3.....
Seat row/number(s):	4.....
Method of delivery:	post
Total payment:	£39
Card details:	
Type:	5.....
Number:	6.....
Name:	Mr. J. 7.....
Address:	
	8..... Street, London
	9.....
Additional requests:	
	put on the mailing list
	book 10.....

SECTION 2 Questions 11-20

Questions 11-17

Label the plan of the rock festival site below.

Choose SEVEN answers from the box and write the correct letter, A-I, next to question 11-17.

- | | | |
|------------------|------------------------|--------------|
| A art exhibition | E exhibitors' entrance | I restaurant |
| B band entrance | F fringe stage | |
| C car park | G lock-up garages | |
| D craft fair | H main stage | |

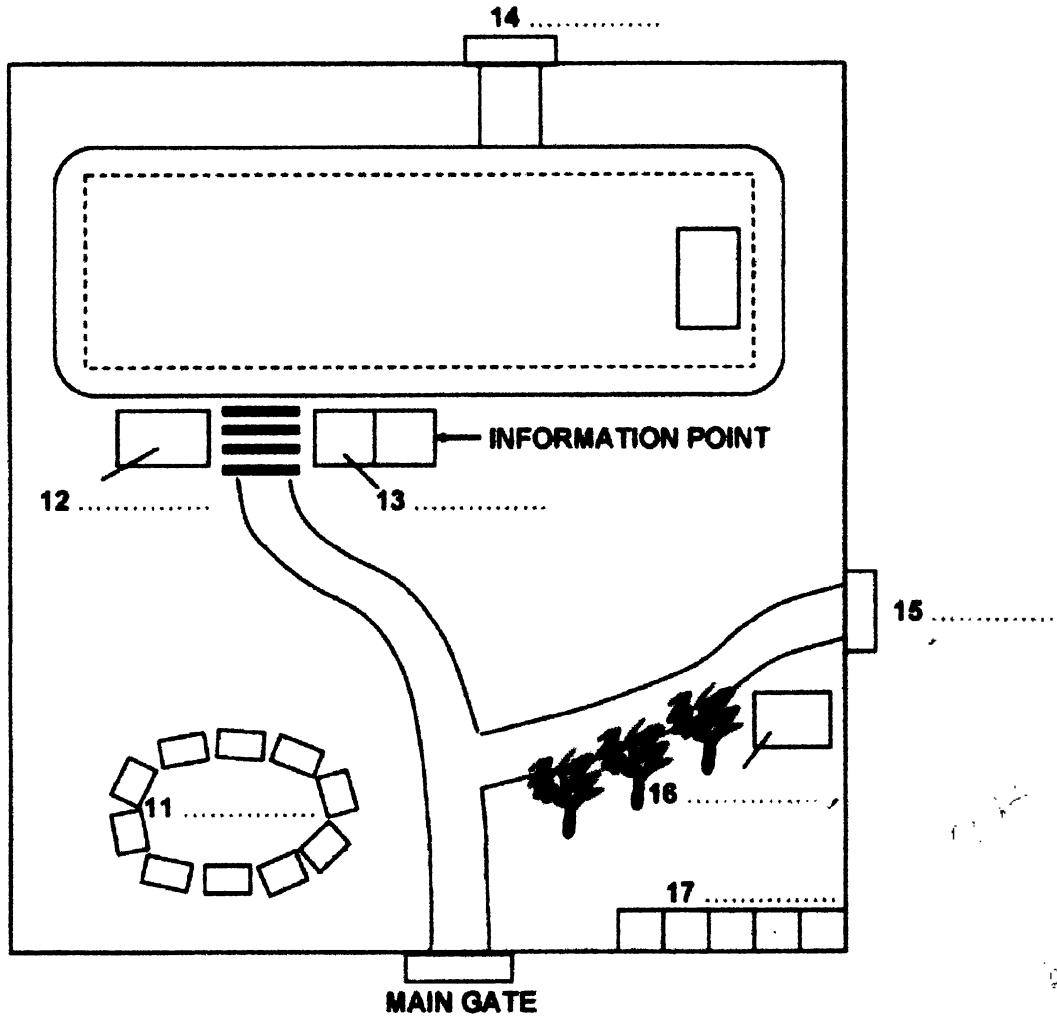

Questions 18-20

Complete the sentences below.

Write **NO MORE THAN TWO WORDS** for each answer.

18 To show you are an official visitor, you have to wear the provided.

19 Cars blocking paths could prevent access by in an emergency.

20 To reclaim item from storage, you must show your
enter to get the storage

SECTION 3 Questions 21-30

Questions 21-23

Choose **THREE** letters, A-G.

Which **THREE** factors does Marco's tutor advise him to consider when selecting a course?

A possibility of specialization

D organization of course

G reputation of lecturer

B relevance to future career

E assessment methods

C personal interest

F range of topics

*band
writing
clothes*

Questions 24-27

Choose the correct letter, A, B or C.

24 Why does Marco's tutor advise him to avoid the Team Management course?

- A It will repeat work that Marco has already done.
- B It is intended for students at a lower level than Marco.
- C It may take too much time to do well.

25 Why does Marco want to do a dissertation?

- A He thinks it will help his future career.
- B He would like to do a detailed study.
- C He has already done some work for it.

26 What does Marco's tutor think about the dissertation outline?

- A The topic is too narrow to be useful.
- B The available data may be unsuitable.
- C The research plan is too complicated.

27 What does Marco decide to do about his dissertation?

- A contact potential interviewees
- B change to another topic
- C discuss it with Professor Briggs

Questions 28-30

Complete the sentences below.

Write **NO MORE THAN TWO WORDS** for each answer.

Practical details

28 A first draft of the dissertation should be completed by the end of

29 The dissertation should be registered with the of the department.

30 Marco should get a copy of the statistics software from the

SECTION 4 Questions 31-40

Questions 31-33

Write **ONE WORD ONLY** for each answer.

The Tiger Shark

- Origin of name: its dark bands
- Size: 6.5 meters (maximum)
- Preferred habitat: near to the **31**.....
- Typical food: other sea creatures but also **32**..... produced by humans
- Raine Island area: studies show tiger sharks are mainly found here during the **33**..... (when turtles are nesting)

Questions 34-38

Complete the flow-chart below

Write **ONE WORD ONLY** for each answer.

Shark Tagging Process

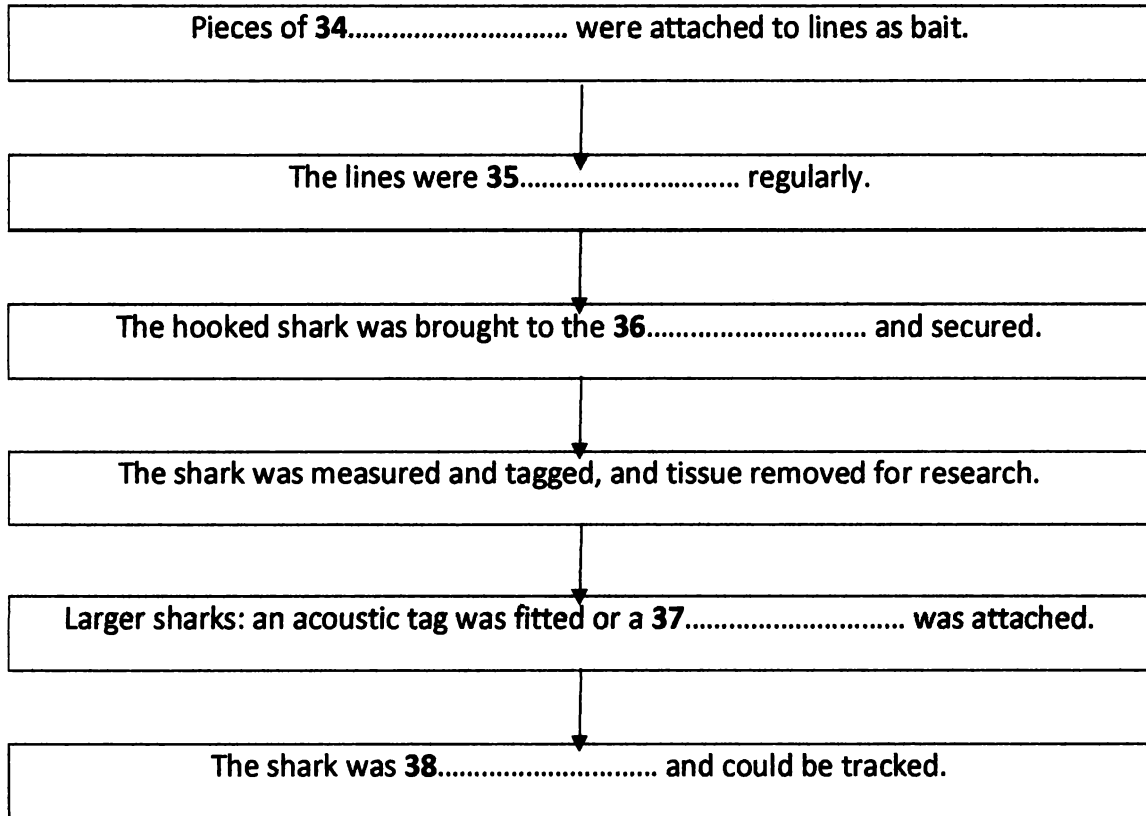

Questions 39 and 40

Choose the correct letter, **A**, **B** or **C**.

39 The purpose of the research was to understand the tiger sharks'

- A** reproductive patterns.
- B** migration patterns.
- C** feeding patterns.

40 Observations showed that, in general, tiger sharks

- A** change depths frequently.
- B** usually avoid the surface of the water.
- C** often spend long periods on the ocean floor.

TEST 5

SECTION 1 Questions 1-10

Questions 1-4

Complete the table below.

Write **NO MORE THAN TWO WORDS AND/OR A NUMBER** for each answer.

City Bank Customer Service Log

<i>Example</i>	<i>Answer</i>
Type of query:	<u>Term deposits</u>



Customer name: David 1.....
 Phone: 023 – 561 – 055
 D.O.B.: 18/02/1968

Customer's Term Deposit details:

Amount: \$18,000
 Term: 2.....
 Interest rate: 3.45%per annum

Current Term Deposit interest rates:

1 year 3.65% per annum
 2 years 3..... % per annum

4..... Term Deposits

Minimum deposit: \$20,000

Questions 5-10

Complete the table below.

Write **NO MORE THAN TWO WORDS AND/OR A NUMBER** for each answer.

5..... tax rate:	28%	
Investment returns	Depend on 6.....	
Term	Effective rate of return	
2 years	Salary \$48,001 - \$70,000 3.76% per annum	Salary \$70,001 – 7 \$..... 3.92% per annum
Minimum investment amount:	\$10,000	
Hidden charges/fees:	8.....	
Interest payment options:	monthly, 9..... 6-monthly, annually.	
Application options:	online 10..... in person	

SECTION 2 Questions 11-20

Questions 11-15

Choose the correct letter, **A, B or C.**

- 11** The September Celebration day is held . . .
 A five times a year to honour the city
 B on the park's important birthday
 C to remember the history of the park
- 12** The park was first built in . . .
 A 1955
 B 1979
 C the 1990s
- 13** The park still uses . . .
 A a children's play area
 B a petting zoo
 C two of the early rides



- 14** The Hurricane roller-coaster is . . .
- A tall and made of wood
 - B designed for smaller children
 - C very fast and exciting
- 15** The rides with a height limit are coded . . .
- A yellow
 - B blue
 - C black

Questions 16-20

Complete the notes below.

Write **NO MORE THAN TWO WORDS** for each answer.

Food options:

- Italian, Chinese, etc. at the Food Court
- Hamburgers, sandwiches, etc. at 16.....

Special Events:

Parade

- Starts at noon
- On the 17..... Run by final year high school students
- Concert
- At the amphitheater
- Theme: 18.....
- Starts at 7:00

Safety and Security

- Ten 19..... centres in the park
- Children ask any staff member for help
- Ask security team at the 20.....

SECTION 3 Questions 21-30

Questions 21-24

Complete the flowchart below.

Write **NO MORE THAN TWO WORDS** for each answer.

Session outline:

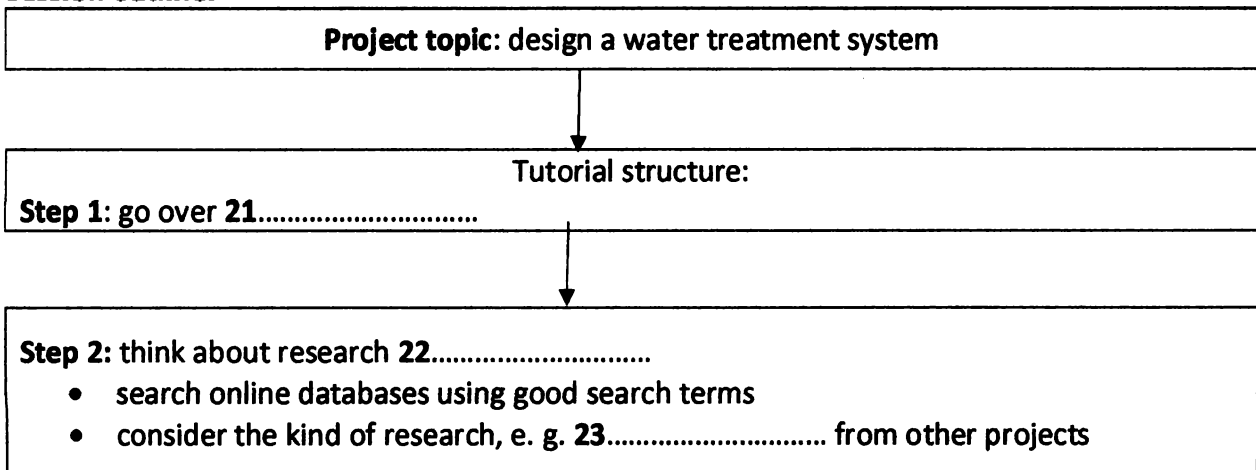



Step 3: develop an 24.....

Questions 25-27

Complete the summary below.

Write **NO MORE THAN ONE WORD** for each answer.

Project description:

You need to design a grey-water treatment system to reduce the pressure on the water

25..... in a Cameroon village. Grey-water is wastewater from household

26..... The system needs to treat this water to remove bacteria, and recycle it to use for purposes such as watering plants, flushing toilets and doing 27.....

Questions 28-30

Complete the notes below.

Write **NO MORE THAN TWO WORDS** for each answer.

Research tips

General internet searches:

Avoid websites where 28..... try to sell their products.

Engineering library:

Use key words when searching the catalogue

e.g. grey-water treatment systems 29..... use

EWB website:

Check examples from the 30..... last year.

SECTION 4 Questions 31-40

Questions 31-34

Complete the summary below.

Write **NO MORE THAN TWO WORDS** for each answer.

Origins of the Caveman Diet

There are many popular fad diets nowadays. They all promise good health if you stick to the

31..... The Caveman diet is a popular example. This diet includes foods such as

lean meat and fish that our forebears ate before web developed 32..... We need

to find out what our ancestors did eat, so researchers are studying some existing hunter-

gatherer tribes. These tribes typically like to eat meat but they can't always get it, even though

they are skilled with their weapons, e. g. 33..... and So, instead,

they eat foods that their wives gather. They get only about a 34..... of their energy from meat.

Questions 35-36

Choose the correct letter, **A**, **B** or **C**.

35 Research evidence suggests that ...

A the tribesmen's traditional diet is unhealthy.

B our bodies can digest only certain foods.

C we can adapt to a range of diets.

36 Thai people have difficulty digesting milk because ...

A they have too much lactase in their bodies.

B in the past they didn't farm cows.

C their saliva lacks certain enzymes.



Questions 37-40

Complete the notes below.

Write **NO MORE THAN TWO WORDS** for each answer.

Variation in global diets:

- Inuit – most calories from **37**..... foods, e. g. seal meat
- Jains – vegetarian, but milk is permitted
- Others – fish, insects.

Implications for the caveman diet:

- Cavemen did not all eat the same diet
- Diets come from complicated cultural **38**.....

Problems with Caveman diet:

- Costs a lot of money for lean meat and **39**.....
- Too much red meat may be unhealthy
- Reliance on meat is bad for the **40**.....

TEST 6

SECTION 1 Questions 1-10

Question 1-3

Choose the correct letter, **A, B or C**.

Example What time is it in Australia when the woman telephones?

- A** 9.00 am
- B** 9.30 am
- C** 10.00 am

1 How many people can climb the bridge in one group?

- A** 6
- B** 12
- C** 18

2 How much does it cost for an adult to climb during the week?

- A** \$100
- B** \$169
- C** \$189

3 How long does it take to climb to the top of the bridge?

- A** one hour
- B** two hours
- C** three hours

Questions 4-7

Answer the questions below.

Write **NO MORE THAN THREE WORDS** for each answer.

4. What are the climbers not allowed to take with them?

5 What do the climbers receive after the climb?

Which **TWO** things must the climbers bring to wear?

- 6
- 7

Question 8-10

Complete the form below.

Write **NO MORE THAN TWO WORDS AND/OR A NUMBER** for each answer.

CUSTOMER ENQUIRIES

Caller's name Julia 8

Calling from Seattle, USA

Email address 9@com

Date of climb 10

SECTION 2 Questions 11-20

Questions 11 and 12

Choose **TWO** letters, **A-E**.

Which **TWO** things does the speaker mention about public clocks?

The fact that they are

- A old D beautiful
- B accurate E free
- C useful F noisy

Questions 13-20

Complete the table below.

Write **NO MORE THAN THREE WORDS AND/OR A NUMBER** for each answer.

PUBLIC CLOCKS

City	Name	First year of service	Special feature	Favorite aspect for speaker
London	Big Ben refers to the 13	1859	Biggest bell in England	It is very 14
Vancouver	15	16	Whistle sounds on the quarter hour	It is charming
Strasbourg	Strasbourg Cathedral clock	1842	The clock tells the story of the 17	It is a 18
Tehran	19	2005	Run by a 20	It is an unusual design

SECTION 3 Questions 21-30

Complete the table below.

Write **NO MORE THAN TWO WORDS** for each answer.

RESEARCH METHODS

	Strengths	Weaknesses
IN THE LABORATORY e.g. medical research	The environment is 22 It is easier to isolate key variables. The researcher can use 23	Constraints affect the ecological validity. Subjects must agree to participate, so there may be a possible distorting effect on 24



IN THE FIELD or 21 setting, e.g. family research	Good ecological validity	There may be unwanted effects e.g. 25 in a sleep experiment. 26 the research can be difficult
---	--------------------------	---

Question 27

Answer the question below.

Write **NO MORE THAN THREE WORDS** for the answer.

27 The students' research will take place on a

Questions 28-30

Choose **THREE** letters, **A-G**

Which **THREE** practical aspects of the research does the tutor highlight?

- | | |
|-----------------------------------|----------------------------|
| A conducting street interviews | E helping subjects respond |
| B selecting subjects | F deciding on a timescale |
| C deciding delivery methods | G interviewing neighbours |
| D recording addresses of subjects | |

SECTION 4 Questions 31-40

Questions 31-36

Complete the notes below.

Write **NO MORE THAN TWO WORDS** for each answer.

An electronic trail allows authorities to track

- First, where your car went
- Second, **31** you travelled

Tracking systems:	
reduce traffic accidents	and promote 32
manage the traffic	and reduce 33
discourage 34	and help police locate vehicles

Electronic plates (E-plates)

- Fitted with ID Tag
- Sent out a **35**
- Cars identified from distance of 100 metres
- Ten-year **36**

Questions 37-40

How do countries feel about E-plate trials?

Choose the correct letter, **A, B or C.**

Countries

- 37** United Kingdom
- 38** United States
- 39** Malaysia
- 40** Australia

<p>A in favor of trialling</p> <p>B no plans to trial</p> <p>C undecided on trialling</p>
--



TEST 7

SECTION 1 Questions 1-10

Questions 1-6

Complete the form below.

Write **NO MORE THAN THREE WORDS AND/OR A NUMBER** for each answer.

PATENT CARD

Time of appointment	Example: 10.00 am
Given names	Simon 1
Family name	Lee
Date of birth	2 1989
Address	3, Adams Terrace, Wellington
Phone no.	0211 558809
Name of insurance company	4
Date of last eye test	5
Patient's observations	6 Problems seeing

Questions 7-10

Answer the questions below.

Write **NO MORE THAN THREE WORDS** for each answer.

- 7 When must Simon wear his glasses?
- 8 What type of glasses are the least expensive?
- 9 What is good about the glasses Simon chooses?
- 10 How does Simon decide to pay?

SECTION 2 Questions 11-20

Choose the correct letter, **A, B** or **C**.

11 Who is buried in the tomb of the Taj Mahal?

- A the emperor Shahjahan
- B the wife of Shahjahan
- C the emperor and his wife

12 Where did the white marble come from?

- A India
- B China
- C Persia

16

Questions 13-16

Label the plan below.

Write **NO MORE THAN THREE WORDS** for each answer.

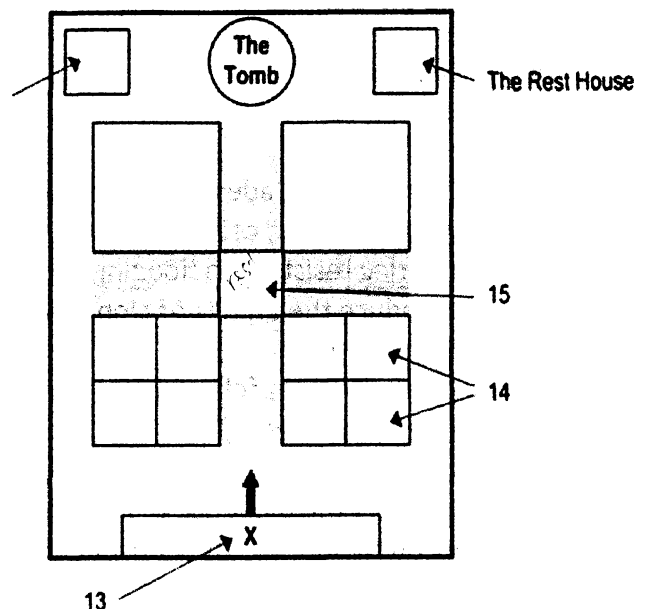



Question 17

Choose the correct letter, A, B or C.

17 What is the purpose of the Rest House?

A a place for the poor to stay

B a meeting place for pilgrims

C an architectural feature

Questions 18-20

Complete the flow chart below.

*Write **NO MORE THAN TWO WORDS** for each answer.*

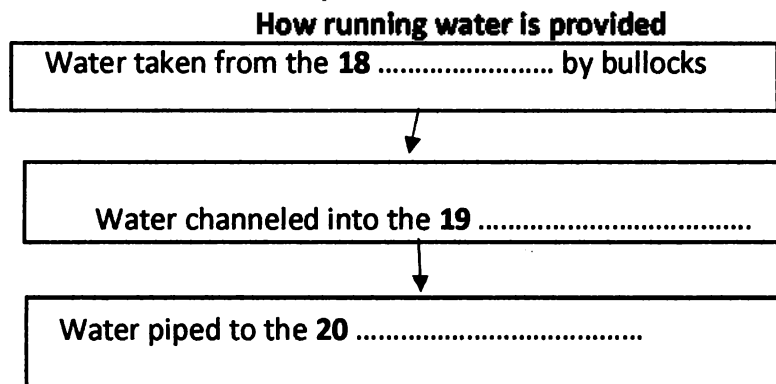

SECTION 3 Questions 21-30

Questions 21-24

Choose the correct letter, A, B or C.

21 What background information does Daisy give about rice?

A Wild rice is grown throughout Asia

B Some types of rice need less water than others

C All rice varieties have a lovely name

22 Erik says that a priority for rice farmers is to be able to

A grow rice without fertilizers

B predict the weather patterns

C manage water resources

23 Where is the International Rice Research Institute?

A The Philippines

B China

C Japan

24 Scientists in Bangladesh want to find a

A more effective type of fertilizer

B strain of rice resistant to flooding

C way to reduce the effects of global warming

Questions 25-30

Which country do the following statements apply to?

Choose the correct letter, A, B or C.

25 They grow the most rice in the world

26 They export the most rice in the world

27 They aim to increase the nutritional value of rice

28 Less rice is eaten than in the past

A Japan

B China

C Thailand



- 29 An annual rice festival takes place
30 A new type of rice is now popular locally.

SECTION 4 Questions 31-40

Complete the sentences below.

Write **NO MORE THAN ONE WORD** for each answer.

RADIO WRITING

- 31 You may have to ignore some of the ordinary of writing.
32 Written words do not indicate things like emphasis, the of reading or where to pause.
33 A script needs to sound like a

Questions 34-40

Complete the notes below.

Write **NO MORE THAN THREE WORDS** for each answer.

Know who you are talking to

Imagine a typical listener:

e.g. imagine telling your 34 about a film

Create an informal tone:

e.g. use words like 35 and

Work out what you are going to say

Remember: listeners cannot ask questions

You cannot 36 ideas

Make your script logical:

- 37 the information
- 38 Use concrete images e.g. compare the size of a field to a 38
- Use the 39 to get attention
- Check the script by 40

TEST 8

SECTION 1 Questions 1-10

Questions 1-5

Complete the form below.

Write **NO MORE THAN TWO WORDS AND/OR A NUMBER** for each answer.

HOTEL

Booking Form

Example	Answer
Arrival date:	23 rd August
Length of stay:	1
Type of accommodation	2
Name:	Mr and Mrs 3 and children
Address:	29 Tower Heights, Dunbar 4
Postcode:	EH41 2GK
Contact telephone:	5
Purpose of trip:	holiday

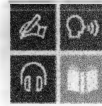

Questions 6-10

Complete the form below.

Write **NO MORE THAN TWO WORDS AND/OR A NUMBER** for each answer.

Tourist Board

Questions for holidaymakers

Favorite activity: 6

Beaches: busy but 7

Shop staff: are sometimes 8

Waiters: 9 and quick

Suggestions: need some 10 for hire

SECTION 2 Questions 11-20

Questions 11-15

Complete the notes below.

Write **NO MORE THAN TWO WORDS AND/OR A NUMBER** for each answer.

ORANA WILDLIFE PARK

Facts about Orana

- Orana means "11"
- The park has animals from a total of 12
- The animals come from many parts of the world.

Things to do at Orana

- 13 the giraffes at 12 or 3pm
- Touch the animals in the 14 (good for children)
- Watch the cheetahs doing their 15 at 3.40

Questions 16-20

Label the plan below.

Write the correct letter, A-I, next to questions 16-20.

16 New Zealand birds 19 Afternoon walkabout meeting place

17 African village 20 Jomo's café

18 Picnic area

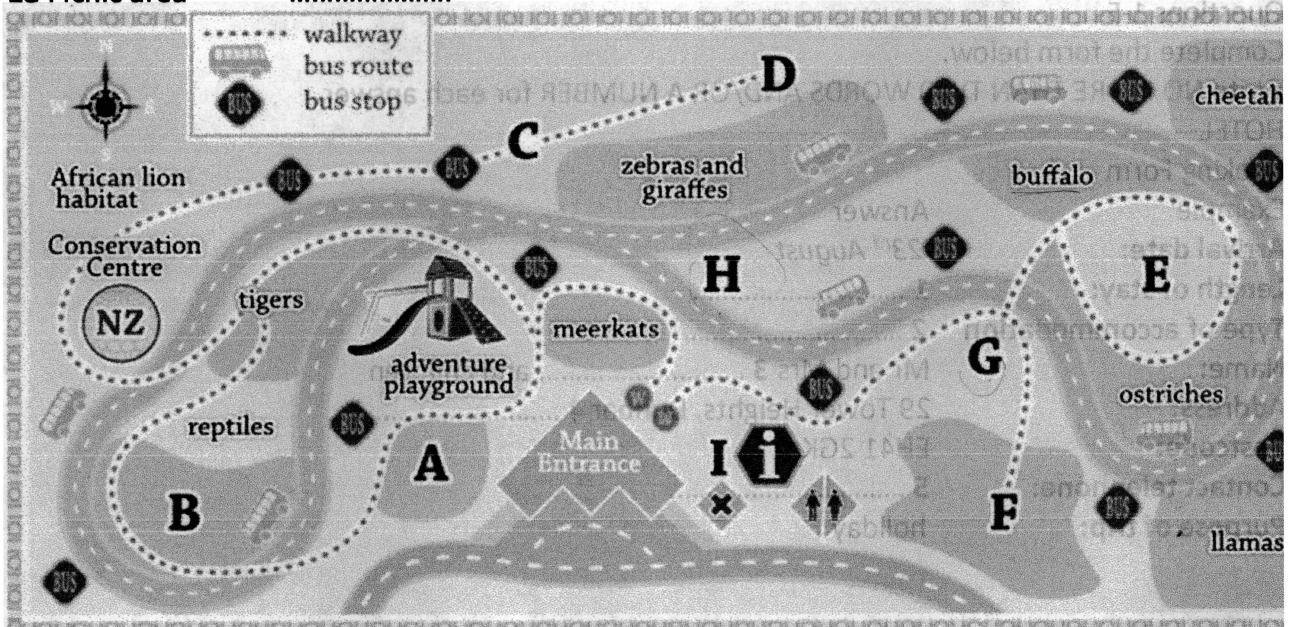



SECTION 3 Questions 21-30

Questions 21-27

Choose the correct letter, **A**, **B** or **C**.

21 The students did the study skills course because

- A** it was part of their syllabus
- B** they needed it to prepare for an exam
- C** their tutor recommended it

22 Why did Sylvie and Daniel use a questionnaire?

- A** Other students preferred the method
- B** It reduced the preparation time
- C** More information could be obtained

23 How often did the students meet in class for the course?

- A** once a week
- B** twice a week
- C** every weekday

24 Why did Daniel like the course?

- A** It improved his confidence
- B** It focused on economics articles
- C** It encouraged him to read more books

25 What did the students like about Jenny?

- A** her homework assignments
- B** her choice of study material
- C** her style of teaching

26 Which chart below shows how useful students found the course in general?

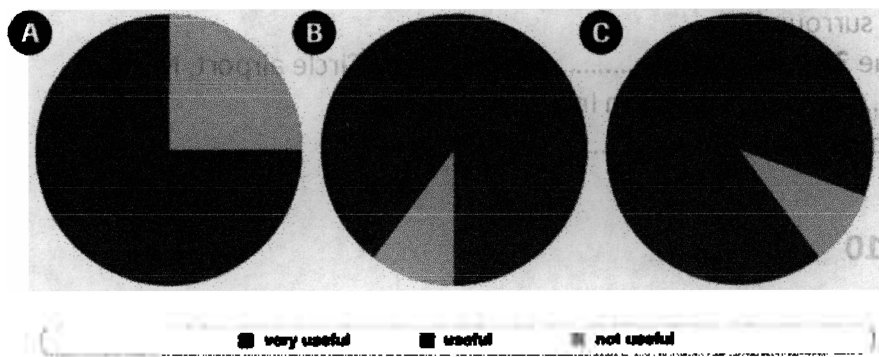

27 Which graph below shows how useful students found the different parts of the course?

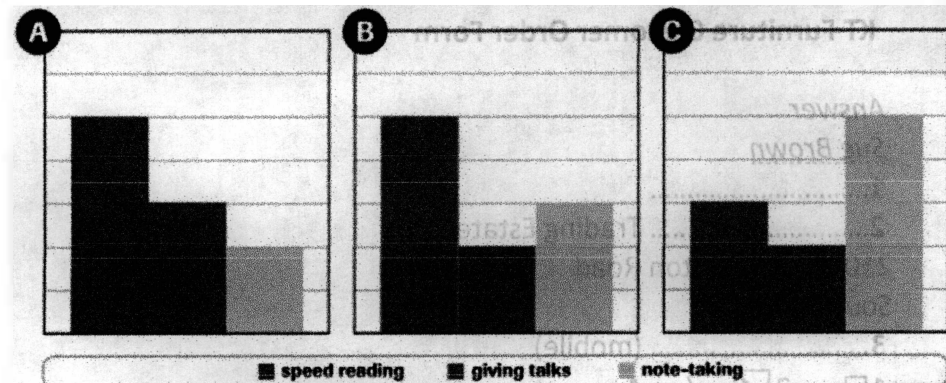

Questions 28-30

Complete the sentences.

Use **NO MORE THAN TWO WORDS** for each answer.

- 28 Good note-taking improves concentration during
- 29 Making notes with the help of a is useful.
- 30 Having a on note paper makes notes easier to read.

SECTION 4 Questions 31-40

Questions 31-40

Complete the notes below.

Write **NO MORE THAN TWO WORDS** for each answer.

AIRPORT DESIGN

Can compare a past airport to a 31.....
Now, can compare an airport to a small 32

Reasons for changes

- Greater passenger numbers because of
 - 33 (e.g. package deals)
 - 34 (e.g. meetings)
- Need to create a good 35 of a country
 - airports called 'gateways'

Types of changes

Inside the building

- many big 36 provide space and light (e.g. Beijing airport)
- calm atmosphere with easy movement reduces 37 for passengers

The exterior of the building

- designed to match the surroundings
 - e.g. the shape of the 38 on the Arctic Circle airport, Norway
 - the 39 outside airports in India and Thailand
- structural design reduces 40 and costs

TEST 9

SECTION 1 Questions 1-10

Questions 1-5

Complete the form below.

3

Write **NO MORE THAN THREE WORDS AND/OR A NUMBER** for each answer.

KT Furniture Customer Order Form

Customer details

Example

Answer

Caller's name

Sue Brown

Company name:

1.....

Address:

2..... Trading Estate
210 New Hampton Road
South Down

Contact number:

3..... (mobile)

Delivery option:

1 2 (no 4.....)

Method of payment: credit card **Type:** 5.....

Questions 6-10

Complete the table below.

Write **NO MORE THAN TWO WORDS AND/OR A NUMBER** for each answer.

Office chairs	ASP 23	6.....	5
7.....	8.....	number of items	2
Leather sofa	DFD 44	9.....	1
10.....	TX 22	silver	1

SECTION 2 Questions 11-20

Questions 11-17

Complete the sentences below.

Write **NO MORE THAN TWO WORDS** for each answer.

Marathon – tips for spectators

- 11 To enjoy the day, make sure you it first.
- 12 Travel within the city centre.
- 13 Wear on the day.
- 14 Check the the night before the marathon.
- 15 Let the give drinks to runners.
- 16 Stay on one side of the road to avoid
- 17 Don't arrange to meet runners near the

Questions 18-20

What does the speaker say about the following forms of transport?

Write the correct letter, **A, B, C, D** or **E**, next to questions 18-20

- A** will take more passengers than usual
- B** will suit people who want to see the start of the race
- C** waiting times will be longer than usual
- D** will have fewer staff than usual
- E** some work schedules' will change

- 18 taxis
- 19 trams
- 20 buses

SECTION 3 Questions 21-30

Questions 21-26

Choose the correct letter, **A, B** or **C**.

21 What does Ahmed say about last week's seminar?

- A** He wasn't able to get there on time.
- B** He didn't know all the students.
- C** He couldn't understand everything.

22 What does the tutor say about Ahmed's preparation for the seminar?

- A He was better prepared than some students.
- B He completed some useful work.
- C He read some useful articles.

23 What does Ahmed say about his participation in the seminar?

- A He tended to speak to his neighbor only.
- B He spoke when other students were talking.
- C He felt embarrassed when students looked at him.

24 What does Ahmed worry about most in seminars?

- A speaking at the right time
- B taking enough notes
- C staying focused

25 What does Ahmed say about his role in the group?

- A He hasn't thought about it.
- B He'd like to change it.
- C He feels he is acting a part.

26 At the next seminar, Ahmed's tutor suggests that he should

- A give other students more help with their work.
- B observe the behavior of other students.
- C ask other students for their views.

Questions 27 and 28

Choose **TWO** letters, **A-E**.

Which **TWO** strategies does the tutor suggest for the next seminar?

- A speak more frequently
- B behave in a confident manner
- C sit next to someone helpful
- D listen to what other people say
- E think of questions to ask

Questions 29 and 30

Choose **TWO** letters, **A-E**.

Which **TWO** suggestions does the tutor make about taking notes?

- A plan them before the seminar
- B note down key words that people say
- C note points to say later
- D include self-analysis
- E rewrite them after the seminar

SECTION 4 Questions 31-40

Complete the notes below.

Write **NO MORE THAN TWO WORDS** for each answer.

DESERT PLANTS

Background

- Deserts found in what is known as a **31**..... (or dry area)
- Annual rainfall, if any, amounts to a **32**.....
- Soil contains a lot of salt and **33**.....



General adaptations of desert plants

- They can **34**..... and store water.
- They have features that reduce water loss.

Examples of adaptations

- Saguaro Cactus: stores water in its **35**.....
- Barrel Cactus: can **36**..... or shrink according to weather
- Old Man Cactus: has **37**..... that reflect the sun
- Prickly Pear Cactus: has **38**..... to keep away animals
- Desert Spoon: leaves are **39**..... to reduce water loss
- Aloe Plant: leaf surface acts like a **40**..... covering and keeps water inside

TEST 10

SECTION 1 Questions 1-10

Questions 1-5

Complete the form below. /

Write **ONE WORD AND/OR A NUMBER** for each answer.

Application form

Name: Jenny Foo
 Age: 21
 Nationality: 1.....
 Address: 2..... Road, Bondi
 Mobile phone: 3.....
 Occupation: 4.....
 Free-time interests: Singing and 5.....

Questions 6-10

Choose the correct letter, **A**, **B** or **C**.

6 According to Don, what might be a problem for Jenny?

- A** her accent
- B** talking to her colleagues
- C** understanding local people

7 How many members does the club have now?

- A** 30
- B** 50
- C** 80

8 How often does the club meet?

- A** once a week
- B** once every two weeks
- C** once a month

9 What is the club's most frequent type of activity?

- A** a talk
- B** a visit
- C** a meal



10 The main purpose of the club is to help members to

- A** meet Australians.
- B** learn about life in Australia.
- C** enjoy themselves together.

SECTION 2 Questions 11-20

Questions 11–15

Choose the correct letter, A, B or C.

11 According to Debbie, why do some people fail to eat a balanced diet?

- A** They don't know how to cook.
- B** They don't have enough time to cook.
- C** They don't feel hungry enough to cook.

12 Debbie recommends that staff should keep fit by

- A** using a gym.
- B** taking up a new sport.
- C** changing some daily activities.

13 Which benefit of exercise does Debbie think is most important?

- A** It helps you sleep.
- B** It keeps your heart healthy.
- C** It improves mental skills.

14 What advice does Debbie give the nurses about health and safety?

- A** to avoid drinking coffee
- B** to use the canteen at night
- C** to take regular breaks

15 When she talks about hygiene, Debbie asks the nurses to

- A** wash their hands regularly.
- B** keep away from germs.
- C** help with the cleaning.

Questions 16-20

Label the map below.

Write the correct letter, A–H, next to questions 16–20.

- 16** recreation centre
- 17** health centre
- 18** swimming pool and sauna
- 19** health-food store
- 20** Jenny's Restaurant

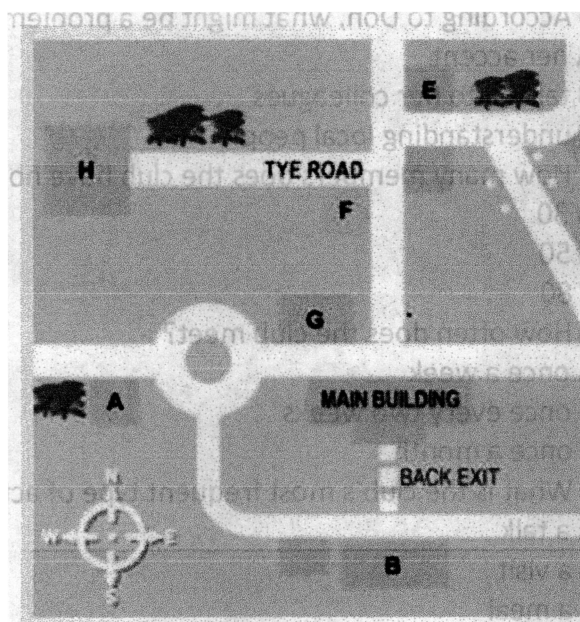

SECTION 3 Questions 21-30

Questions 21–24

Choose **TWO** letters, **A–E**.

Questions 21–22

Which **TWO** activities will students do as part of Amanda's assignment?

- A analyse their own speech
- B record other students' speech
- C read something from a book
- D repeat part of a lecture
- E remember part of a lecture

Questions 23–24

Which **TWO** features must Amanda check when she chooses the extract?

- A the time it takes to read
- B the overall organization
- C the number of words
- D the number of sentences
- E the inclusion of key ideas

Questions 25–28

Which comments do the speakers make about each lecture?

Choose **FOUR** answers from the box and write the correct letter, **A–F**, next to Questions 5–8.

Lectures

- 25 History of English
- 26 Gestures and signs
- 27 Intonation patterns
- 28 Language and rhythm

Comments

- A The content is repetitive.
- B It took a long time to write.
- C It was shorter than the others.
- D It was well structured.
- E The content is relevant.
- F The topic was popular.

Questions 29–30

Answer the questions below.

Write **NO MORE THAN TWO WORDS** for each answer.

Which **TWO** pieces of equipment will the students use in the study?

- 29
- 30

SECTION 4 Questions 31-40

Questions 31–35

Complete the sentences below.

Write **ONE OR TWO WORDS** for each answer.



- 31 Ordinary people can provide a news story, a or a video when no professional journalist is present.
- 32 Amateur journalists often report on subjects which would be of little interest to a large
- 33 In the past, someone who wanted to express an opinion used to write a, while now they write a blog.
- 34 An amateur journalist's subject is more likely to be a rather than national or international news.
- 35 Amateur news websites, such as *Ohmynews* in South Korea, earn money from

Questions 36–40

Complete the flow chart below.

Write **ONE WORD ONLY** for each answer.

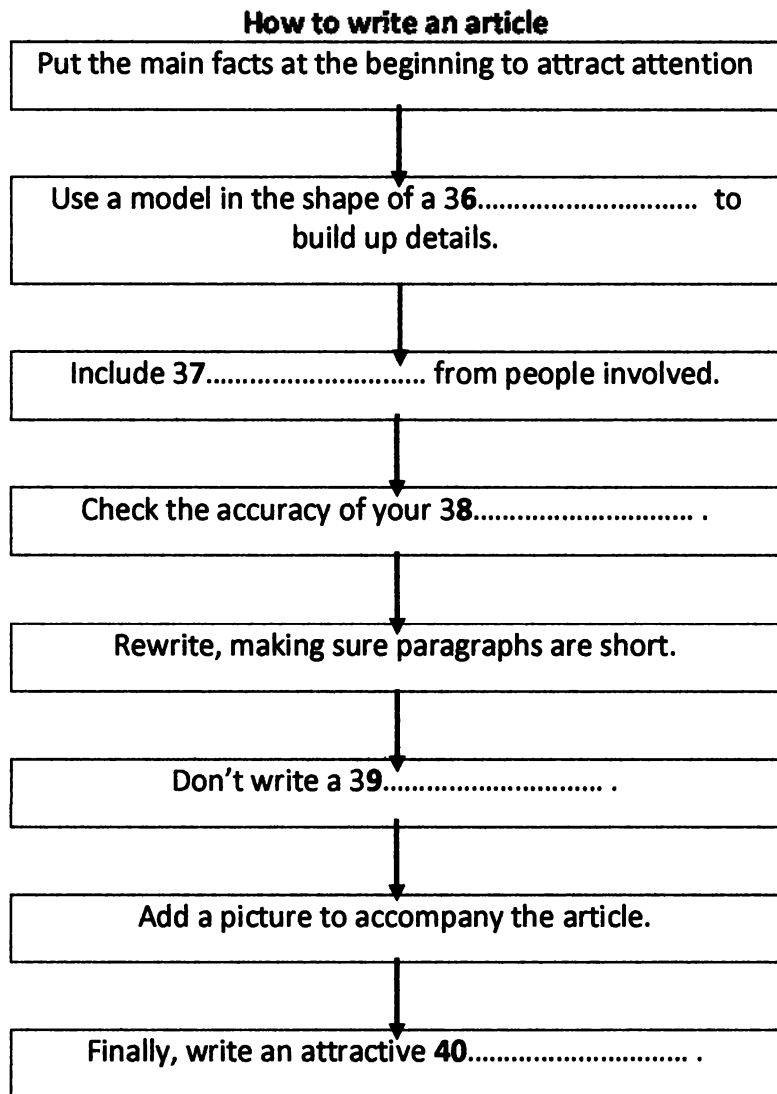



TEST 11

SECTION 1 Questions 1-10

Questions 1-6

Complete the notes below.

Write **NO MORE THAN TWO WORDS AND/OR A NUMBER** for each answer.

Customer's name: Igor Petrov
 Length of holiday: **1**.....
 Will pay up to £ **2**.....
 Told him about **3**..... for advance payments
 Needs quote for **4**..... during holiday
 Requires **5**..... on plane
 Must check if he needs a **6**.....

Questions 7-10

Complete the table below.

Write **ONE OR TWO WORDS** for each answer.

Eco-holidays

	type of holiday	accommodation	advantage
Dumbarton Tablelands	<i>watching animals</i>	<i>house in</i> 7	<i>close to nature</i>
Bago Nature Reserve	<i>live with a</i> 8	<i>village house</i>	<i>learn about way of life</i>
San Luis Island	<i>working in a</i> 9	<i>hostel</i>	<i>holiday location without</i> 10

SECTION 2 Questions 11-20

Questions 11-14

Which bank provides the following?

Choose **FOUR** answers from the box and write the correct letter, **A-F**, next to questions 1-4.

- 11** a branch on the campus
- 12** a free gift for new customers
- 13** special interest rates for students
- 14** no bank charges for certain customers

- | | |
|------------------------|------------------------------|
| A Evergreen | D International Union |
| B Finley's | E Moneysafe |
| C Great Western | F Northern Star |



Questions 15–20

Label the diagram below.

Write **ONE OR TWO WORDS** for each answer.

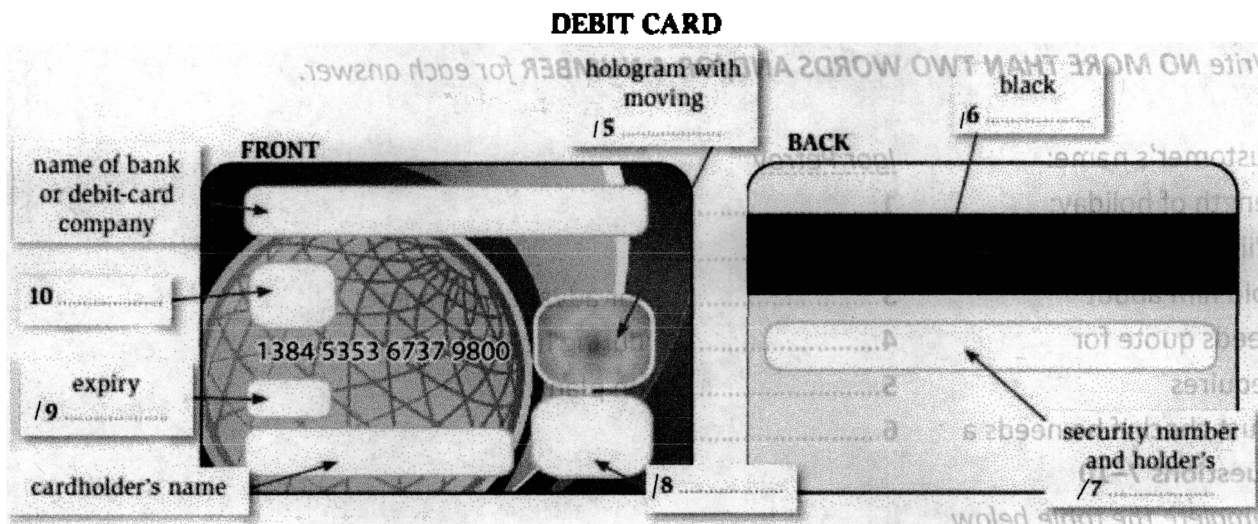

SECTION 3 Questions 21–30

Questions 21–25

Choose the correct letter, **A**, **B** or **C**.

21 What problem does Fumiko have with her psychology project?

- A She isn't interested in the topic.
- B She can't find enough information.
- C She doesn't know what to focus on.

22 What point does Victor make about Fumiko's tutor?

- A He explores his students' key interests.
- B He is a very hard-working member of staff.
- C He uses a limited range of project titles.

23 What has Fumiko already read on her topic?

- A book extracts
- B journal articles
- C internet material

24 According to Mr Dresden, Fumiko's project must include

- A some graphic data.
- B a bibliography.
- C a public survey.

25 Victor and Fumiko arrange to

- A get in contact in half an hour.
- B meet up in the library.
- C have lunch together

Questions 26–30

Complete the flow chart below.

Write **NO MORE THAN TWO WORDS** for each answer.

Fumiko's plan

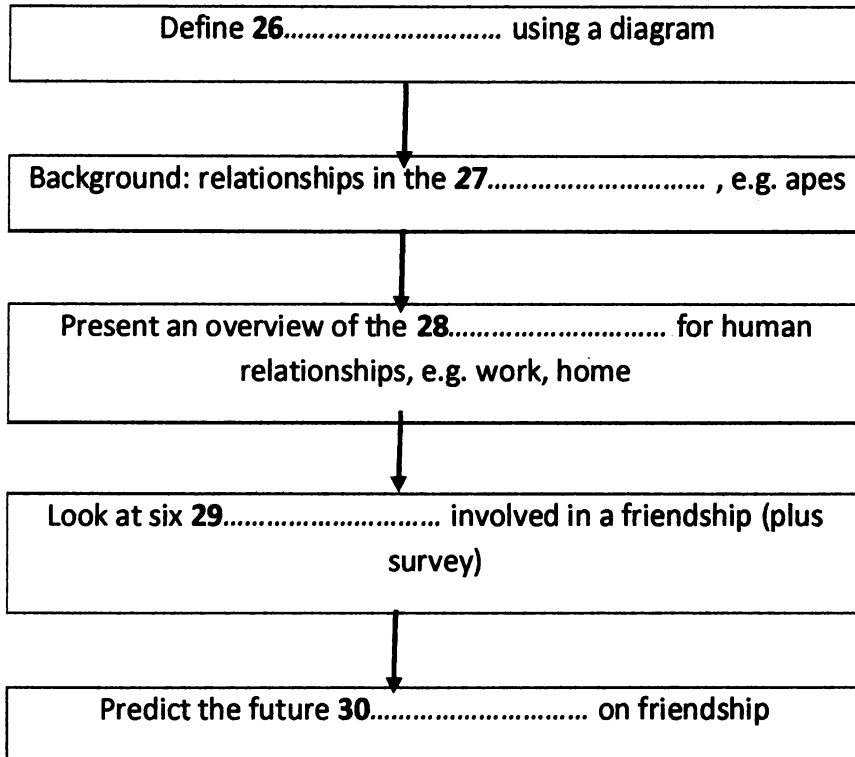

SECTION 4 Questions 31-40

Questions 31-40

Complete the sentences below.

*Write **NO MORE THAN TWO WORDS** for each answer.*

31 The word *sashiko* means '.....'.

32 In the beginning, *sashiko* was rather than decorative.

33 In the past, warm fabrics such as were not available in some parts of Japan.

34 Warm clothes were produced by using *sashiko* to join of material.

35 Traditional *sashiko* designs included one called '.....'.

36 In the towns of ancient Japan, workers such as wore *sashiko* garments.

37 It used to be essential for someone married to a to know how to do *sashiko*.

38 *Sashiko* was not needed when began in northern Japan.

39 Modern *sashiko* patterns include stripes and shapes.

40 Unfortunately, are not as interested in old clothes as in other ancient craft objects.

TEST 12

SECTION 1 Questions 1-10

Questions 1–5

Complete the form below.

Write **NO MORE THAN TWO WORDS AND/OR A NUMBER** for each answer.

INTERVIEW – DETAILS OF SUBJECT

Age group: 25 – 34
 Length of time living in city: **1**.....
 Previous home: **2**.....
 Occupation: **3**.....
 Area of city: **4**.....
 Postcode: **5**.....

Questions 6–10

Choose the correct letter, **A**, **B** or **C**.

6 What does the man say about public transport?

- A** He doesn't like using it.
- B** He seldom uses it.
- C** He has stopped using it.

7 What does the man say about sport in the city?

- A** Some facilities are better than others.
- B** He intends to do more of it in the future.
- C** Someone recommended a place to him before he came.

8 What does the man say about entertainment?

- A** He doesn't have much time for it.
- B** There is a very wide range of it.
- C** It is the best aspect of life in the city.

9 What does the man say about litter?

- A** There is less of it than he had expected.
- B** Not enough is done about the problem.
- C** His home town has more of it.

10 What does the man say about crime in the city?

- A** The police deal with it very efficiently.
- B** It is something that worries him.
- C** He doesn't know how much of it there is.

SECTION 2 Questions 11-20

Questions 11–15

Choose the correct letter, **A**, **B** or **C**.

11 The speaker says that the conference includes issues which

- A** were requested by participants.
- B** are seldom discussed.
- C** cause disagreement.

12 The speaker says that in the past, this subject

- A** caused problems in the workplace.
- B** was not something companies focused on.



C did not need to be addressed

13 The speaker mentions a connection between health and fitness and

A keeping employees.

B employees' performance.

C a company's reputation.

14 What does the speaker say about the people attending the conference?

A Some of them may feel that there is not much they can learn.

B All of them have attended the conference before.

C Most of them are familiar with the speakers.

15 The speaker says that in the sessions, participants will

A work together in pairs.

B pretend to have various roles.

C describe real events.

Questions 16–20

Label the map below.

Write the correct letter, A–H, next to questions 6–10.

16 Setting Up a Fitness Centre

17 Healthy Eating Schemes

18 Transport Initiatives

19 Running Sports Teams

20 Conference Coordinator's Office

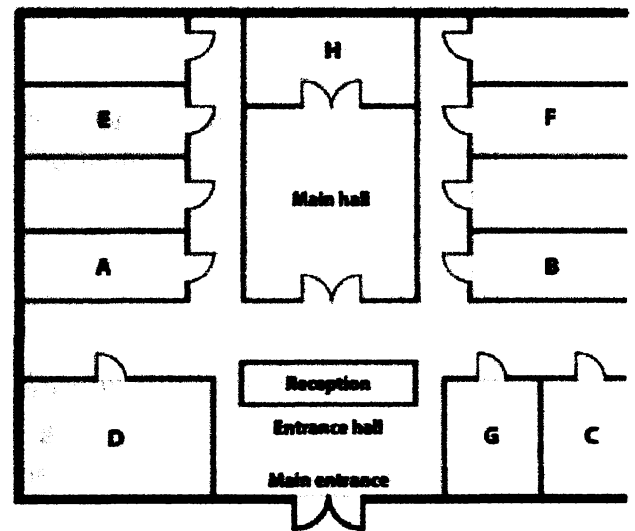

SECTION 3 Questions 21-30

Questions 21–24

Choose TWO letters, A–E.

Questions 21–22

Which TWO areas of work did Beth include in her dissertation?

A retail

B banking

C call centres

D tourism

E translation

Questions 23–24

Which TWO aspects of the dissertation were impressive, according to the tutor?

A summary of academic research

B analysis of videos

C observation of live interactions

D interviews

E analysis of data on the outcomes

Questions 25–28

Which comments do the speakers make about each section of the dissertation?

Choose **FOUR** answers from the box and write the correct letter, **A–F**, next to Questions 5–8.

Sections of Dissertation

- 25 Dealing with Complaints
- 26 Collaborating with Colleagues
- 27 Interacting with Managers
- 28 Giving Instructions

- A There is not enough evidence.
- B The conclusion is confusing.
- C It highlights a real problem.
- D It is particularly well organised.
- E There are too many examples.
- F It includes new ideas

Questions 29–30

Answer the question below.

Write **NO MORE THAN TWO WORDS** for each answer.

Which **TWO** aspects of communication does Beth emphasise in her conclusion?

- 29..... 30.....

SECTION 4 Questions 31-40

Questions 31–35

Complete the summary below.

Write **ONE OR TWO WORDS** for each answer.

Blogs and the History of Blogging

A blog can perhaps be best described as a website that consists of a kind of journal that is regularly updated. Blogs cover a very wide variety of topics and many of them are personal diaries.

Blogs are usually not 31..... because they have interactive elements, which may lead to friendships or even 32..... relationships between people.

The first 'blog' was probably created in 1994 by a student and he called it his

'33.....'. Similar websites were then created and these included both links and

34..... In 1999, someone changed the term used for these websites by creating the phrase '35.....', and therefore invented the term 'blog'.

Questions 36–40

Complete the flow chart below.

Write **ONE WORD ONLY** for each answer.

Blogging Workflow – Advice

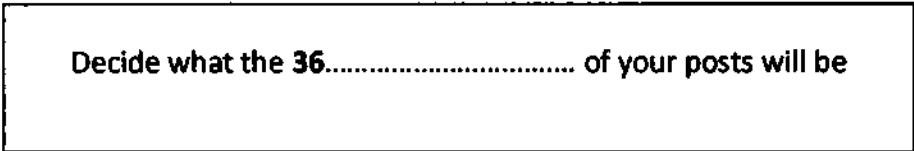

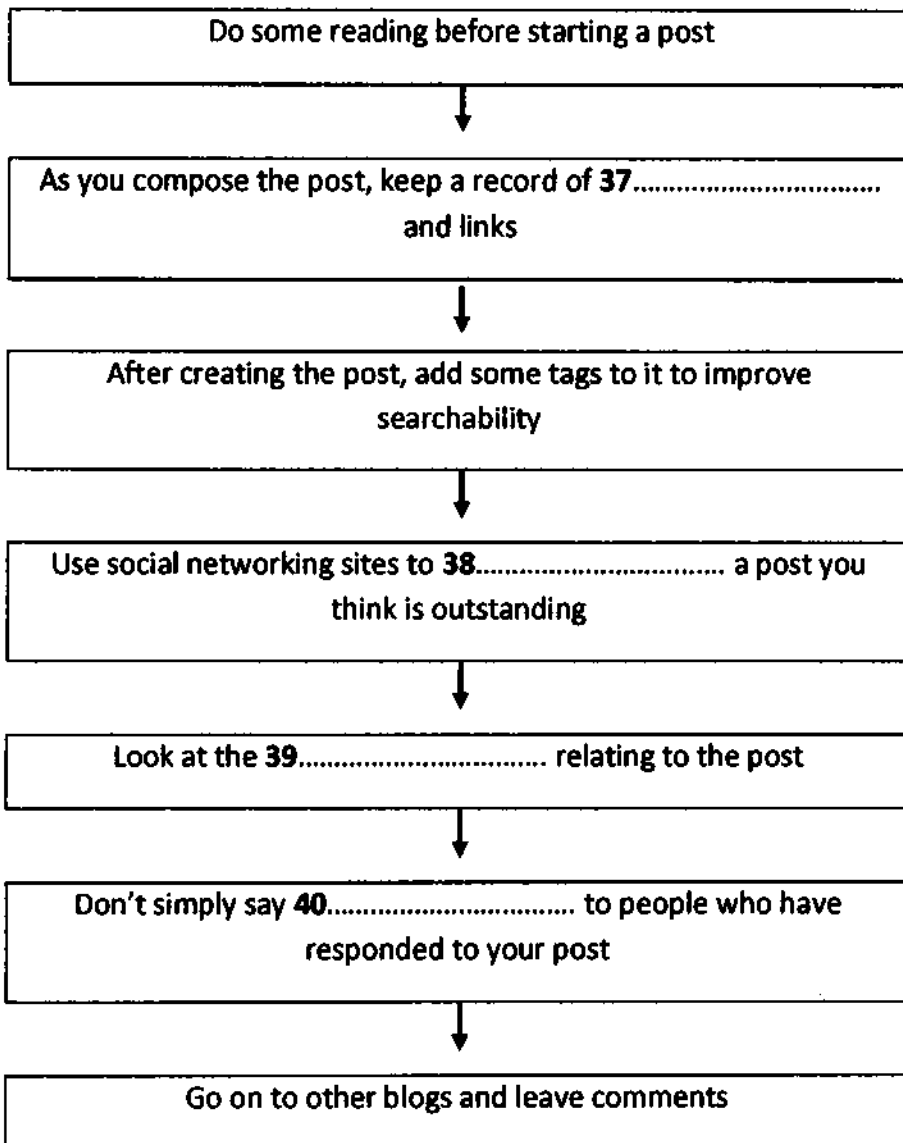

TEST 13

SECTION 1 Questions 1-10

Questions 1–6

Complete the notes below.

*Write **NO MORE THAN TWO WORDS AND/OR A NUMBER** for each answer.*

The Volunteer Agency

- has recruited 1..... people for environmental projects
- project abroad involves doing 2..... or going into the rain forest
- major project for dealing with 3..... in the countryside
- project for improving conditions for 4.....
- 5..... projects in urban areas
- some projects do not have any 6.....

SECTION 3 Questions 21-30

Questions 21–25

Choose the correct letter, A, B or C.

21 Maya chose the topic of lifelong friendships because

A it was an unusual area of research.

B she had a particular interest in it.

C someone suggested it to her.

22 Maya says that the sample of people she used

A was smaller than she wanted it to be.

B was typical of the population in general.

C was the basis for further work.

23 The problem with the questionnaire was that

A it wasn't well constructed.

B the subjects couldn't engage with it.

C too much time was required to complete it.

24 Maya says that when she conducted the interviews,

A she kept brief notes.

B the subjects were all very relaxed.

C they followed a clear structure.

25 What does Maya say about other research in the area?

A A lot of it contradicted her findings.

B It wasn't very easy to find.

C It was carried out in the same way as hers

Questions 26–30

Complete the flow chart below.

Write NO MORE THAN TWO WORDS for each answer.

Lifelong friendships presentation

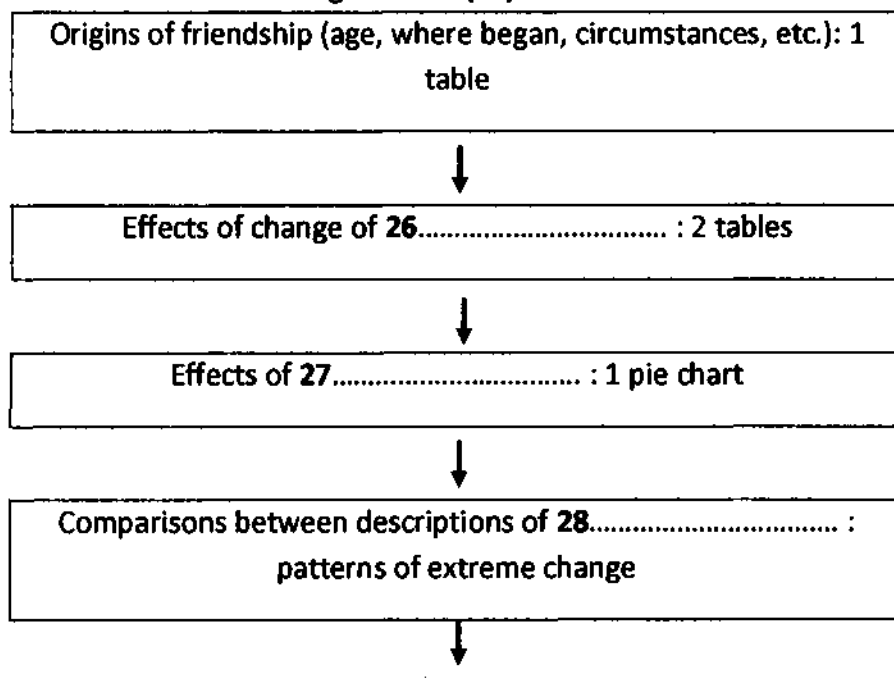



Changes in 29..... : 1 pie chart



30..... (e.g. sports, musical tastes): continuing or changing

SECTION 4 Questions 31-40

Complete the sentences below.

Write **NO MORE THAN TWO WORDS** for each answer.

31 The word jeans may have originated in a material used in clothes worn by from Italy.

32 One difference between jean and denim material concerned the used to create them.

33 Denim was used in the clothes worn by people whose place of work was

34 Strauss's first name was originally

35 The miners' problem concerned the on their clothes.

36 Strauss's clothes solved the problem because they used fasteners.

37 The label Strauss added showed his waist overalls connected to

38 In the 1930s, the clothes became more popular because people saw characters in wearing them.

39 In the 1940s, people in other countries saw the clothes being worn by from the U.S.

40 In the 1950s, teenagers called the clothes

TEST 14

SECTION 1 Questions 1-10

Questions 1 – 5

Complete the form below.

Write **NO MORE THAN ONE WORD AND/OR A NUMBER** for each answer.

Lake Pane Campground, US
Bookings

<i>Example</i>	<i>Answer</i>
Length of stay	..5 nights..

Date of arrival: 1

Family name: 2

Contact number: 3

Camp facilities: 4, water and 5

Questions 6 – 10

Complete the notes below.

Write **NO MORE THAN TWO WORDS AND/OR A NUMBER** for each answer.

Site code: 6

Location: Drive past the offices and 7 Keep going until you reach the 8 Then turn left.

Remember: Do not have 9
Return the 10

SECTION 2 Questions 11-20

Questions 11 – 14

What does the speaker say about the following natural food colourings?

Write the correct letter, A – F, next to questions 11 –14.

- A It is made using another food product.
- B The ingredients are difficult to find.
- C It is also used to dye cosmetics.
- D Sales fell then increased.
- E It can be used to give processed food a uniform colour.
- F It is less popular than other dyes

- 11 green
- 12 brown
- 13 red
- 14 blue

Questions 15 – 17

Choose the correct letter, A, B, C or D.

- 15 When we buy new clothes, our
- A friends may not like the colours we choose.
 - B choice may be based on the colours we see.
 - C ideas about fashion may not be up to date.
- 16 Colourists are people who
- A decide which colours suit us best.
 - B create the dyes that are used to make clothes.
 - C predict which colours will be fashionable in the future.
- 17 What does the speaker say about the colours we wear?
- A The colours we like change as we get older.
 - B Most people prefer light colours to dark ones.
 - C We worry too much about the colour of clothes.

Questions 18–20

Complete the sentences below.

Write **ONE WORD ONLY** for each answer.

- 18 Both a product and its must appeal to consumers.
- 19 Green indicates that businesses care about the
- 20 Blue helps people to think in a more way.

SECTION 3 Questions 21-30

Questions 21 – 26

Complete the table below.

Write **ONE WORD ONLY** for each answer.

International student mobility

Questions	Findings
What is the total number?	<ul style="list-style-type: none"> • About 3 million • Not every country uses the same 21 for an international student. • Figure may be much higher.
What is the global 22 ?	<ul style="list-style-type: none"> • Figures may be inaccurate • 23..... organisations may be ignored
Where do students come from?	Big increases in figure for North America and 24
Are student 25 changing?	<ul style="list-style-type: none"> • More 26 • A spirit of exchange

Questions 27 and 28

Choose **TWO** letters, **A – E**.

When choosing a course, which **TWO** factors did students consider important?

- A** how expensive the course is
- B** the reputation of the institution
- C** the distance from home
- D** the qualifications of the tutors
- E** how useful the qualification will be

Questions 29 and 30

Choose **TWO** letters, **A–E**.

Which **TWO** incentives would encourage graduates to return home?

- A** scholarships for higher degrees
- B** research grants
- C** special housing
- D** lower tax rates
- E** special work zones

SECTION 4

Questions 31–40

Complete the notes below.

Write **NO MORE THAN TWO WORDS** for each answer.

LIONS

Lion history

- Found today in Africa and a **31** in India
- Have lived on every continent apart from Antarctica and **32**

- Killed by early humans:
 - a) in competition for food
 - b) for **33**

Cave paintings

- **34**..... confirms European lions much bigger than African lions
- Date of first appearance of mane **35**

Purpose of mane

- Mane is comparable to **36** in some ways
- Researchers first believed mane used for **37** during fights

The lion expert's study

- Made some **38** with different manes
- **39** manes attracted female lions
- Conclusion: mane is a **40**

TEST 15

SECTION 1 Questions 1-10

Complete the form below.

*Write **NO MORE THAN THREE WORDS AND/OR A NUMBER** for each answer.*

Graduate Fair Registration
TGS Global

Graduate details

Area of work	Example: Marketing
Name:	Dominika 1
Nationality:	2
Email address:	3@gmail.com
University:	London
Type of course:	4 BA
Date available:	5

Personal information

Other activities:	organised a 6 for charity
Interests:	7 and
Previous job(s):	8
Career Plans:	wants to be 9
Heard about fair through:	10

SECTION 2 Questions 11-20

Questions 11 – 16

Complete the table.

*Write **ONE** word for each answer.*



Eye for Colour Exhibition

Section	Aim	Example of activities
'Seeing colour'		view the gallery through a huge 11
'Colour in culture'	to connect colour and 12	<ul style="list-style-type: none"> go to the colour café learn how a 13 affects sight
'Colour in nature'	to look at the natural world	<ul style="list-style-type: none"> put on a camouflage suit and pick a suitable 14 see through the eyes of a dog of fish
'The 15 room'	to show how colours make us feel	listen to music as the colours and 16 change

Questions 17 – 20

Choose **TWO** letters, A - E.

Questions 17 – 18

Which **TWO** colours were most popular among visitors?

A blue B deep pink C lime green D purple E red

Questions 19 – 20

Which **TWO** reasons did the children give for selecting their favourite colour?

- A They like wearing it.
- B They notice it more than other colours.
- C It makes them feel relaxed.
- D It has a connection with a sport.
- E Someone they admire wears it.

SECTION 3 Questions 21-30

Questions 21 – 25

What comments do the speakers make about each treatment or service?

Choose **FIVE** answers from the box and write the correct letter, A – F, next to Questions 21 – 25.

Treatments and Services

- 21 Manual therapy
- 22 Stability training
- 23 Electrotherapy
- 24 Video analysis
- 25 Workstation analysis

Comments

- A It strengthens the whole body.
- B It is the most popular.
- C It requires special sportswear.
- D It is the most effective.
- E It is best done in the evening.
- F It is rarely used.

Questions 26 – 30

Complete the flow chart below.

Write **NO MORE THAN TWO WORDS** for each answer.

Example of patient route

Arrives at clinic with and 26

Physiotherapist evaluates 27 to ankle.

Treatment is given, and an 28 is prepared.

Return trips are made to check joint 29

A 30 supervises activity in the gym.

SECTION 4 Questions 31-40

Complete the notes below.

Write **NO MORE THAN TWO WORDS AND/OR A NUMBER** for each answer.

Australian Aboriginal Art

ANCIENT ART

- Rock and bark painting
- Sand drawings
- 31
- Decoration on weapons and tools
- Cave art**
- protected from 32
- styles include dot paintings (e.g. arrows, water holes and 33) and naturalistic art
- main function: 34
- Use of ochre**
- Reason**
- readily available
- soil or rock contains 35
- produces many colours and shades of red
- artist's palette found that is 36 old
- Preparation**
- ochre collected
- turned into 37
- fluid binder, e.g. tree sap or 38 Added

MODERN ART

- Artists use acrylic colours and 39
- Paint and decorate and a range of 40

TEST 16

SECTION 1 Questions 1-10

Questions 1 – 5

Choose the correct letter, **A**, **B** or **C**.

1 Why did Milton miss the talk on fossils?

- A** He attended a different lecture.
- B** He had to catch up on some work.



- C He was not interested in the subject.
- 2 What started Mr Brand's interest in fossils?
- A a trip to America
B a chance discovery
C a film he saw as a child
- 3 What do schoolchildren say they most enjoy about the fossil hunts?
- A looking for fossils in the rocks
B having their photo taken with a fossil
C being able to take the fossils home
- 4 During a fossil hunt, the main thing children learn is that
- A history is all around them
B it is important to be careful
C patience leads to rewards.
- 5 What do Juni and Milton agree to do?
- A persuade Mr Brand to run a fossil hunt for them
B use the Internet to book a place on a fossil hunt
C talk to some people who have been on a fossil hunt.

Questions 6 – 10

Complete the diagrams.

Write **ONE WORD ONLY** for each answer.

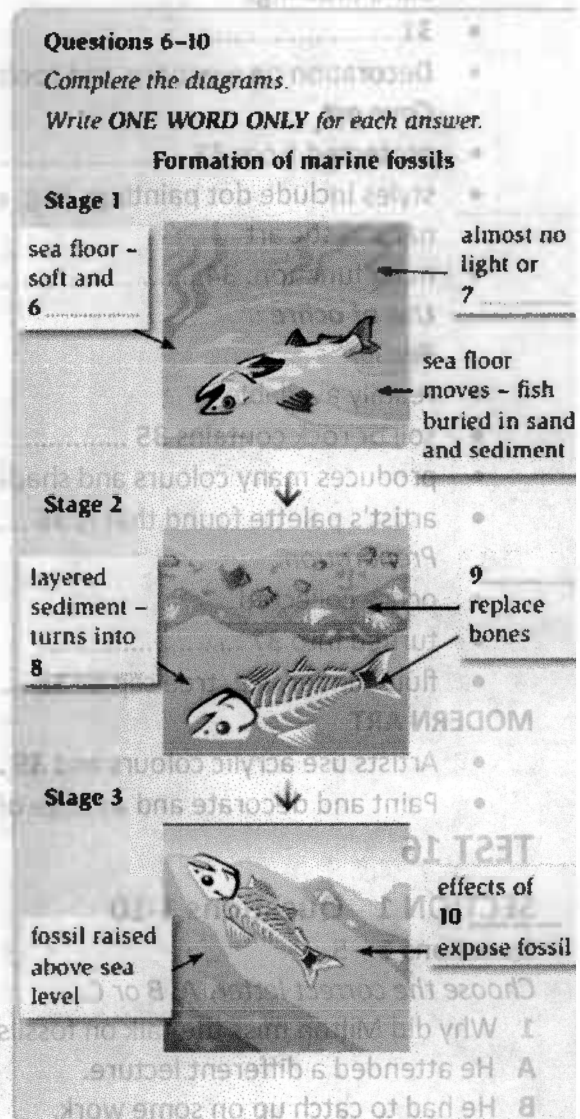



SECTION 2

Questions 11-20

Complete the notes below.

Write **NO MORE THAN TWO WORDS AND/OR A NUMBER** for each answer.

Animation Technology

History

- Thomas Edison: first camera – 1889
- J. Stuart Blackton: first animated film
technique – used many **11** of faces
- Emile Cohl: first animated scene – used cut-outs made of **12**
- Walt Disney: first talking colour film
 - 1928
 - used **13** slides
 first full-length colour film – *Snow White and the Seven Dwarfs* – 1937

Pixar Animation Studios

- Origins: graphics group
- Earnings: over **14** \$ worldwide
- Famous films: 1995 – *Toy Story* – first computer-animated film
2001 – *Monsters, Inc* – included **15** as a new animation feature
Finding Nemo – new techniques in **16**
The Incredibles – believable simulations of people and **17**

Future developments:

- a) Digital humans: focusing particularly on skin and **18**
- b) Speed: companies producing **19** will help
- c) Colour: aim to preserve vibrancy
- d) Styles of animation: a move from **20** to new concepts

SECTION 3 Questions 21-30

Questions 21-23

Label the plan below.

Write the correct letter, A-F, next to questions 21-

23.

21 Oldest Scots pine trees

22 Red deer

23 Red squirrels

Loch Affric in Scotland

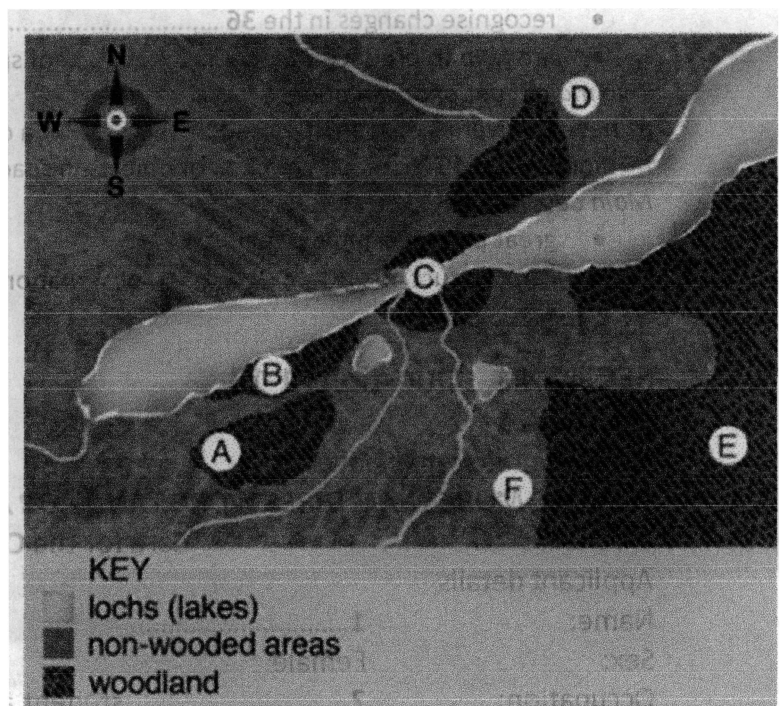

Questions 24 – 25

Answer the questions.

Write **ONE WORD ONLY** for each answer.

24 What can cause someone to miss a good photograph?.....

25 What personal quality do wildlife photographers particularly need?

Questions 26 – 30

Complete the sentences.

Write **NO MORE THAN TWO WORDS** for each answer.

26 In bad weather, think more carefully about the

27 Take advantage of when photographing near water.

28 Use a piece of equipment called an 'angle finder' to avoid

29 Use the work of both artists and to generate ideas.

30 Think about issues when deciding on what to photograph.

SECTION 4 Questions 31-40

Complete the notes below.

Write **NO MORE THAN TWO WORDS** for each answer.

Space observations

Early days

First telescopes - started the 31 '.....'

Galileo's telescope - moved the focus from 32 to the sky

First 33 - by John William Draper (1839)

Present day

Professional astronomers – aim to get 34

Amateur astronomers – aim to photograph beautiful images, e.g. 35 (Greece)

Contribution of amateur astronomers

Specialised knowledge

e.g.

- recognise changes in the 36 of a space object
- are able to produce 37 of space

Two main types of observation

a new discoveries, e.g. an 38 or a comet

b monitor the 39 of objects in space

Main advantages

- great patience and passion
- can conduct 40 observations

TEST 17

SECTION 1 Questions 1-10

Questions 1–12

Complete the form below.

Write **NO MORE THAN THREE WORDS AND / OR A NUMBER** for each answer.

Care for the Community

Applicant details

Name: 1.....

Sex: Female

Occupation: 2..... student at Brookfields University



studying on 3..... Course (BA)

Contact details

Phone: 4.....
 Email: 5.....@chatbox.co.uk
 Availability: Up to 6..... per week.

Other information

- Reason for applying: Would like 7.....
- Area of interest: Children with 8.....
- Experience: Has recently done similar work at 9..... . Found it 10..... .
- Perceived strengths: Has excellent 11..... . Also listens to people 12..... arranged for Wednesday 10th September.

SECTION 2 Questions 11-20

Questions 11–16

Complete the table below.

Write **ONE WORD** for each answer.

Spectrum by Alex Mackenzie

Title of chapter	Theme	Features
“The hidden jungle”	How an animal’s colour and shape can conceal it when it hides or 11..... .	Has some outstanding 12..... .
“A question of choice”	Why people’s colour 13..... differ from others.	A 14..... test which involves readers grading things based on colour.
“It’s all in the 15.....”	How our brain perceives colour.	Describes some 16..... that the reader can do.

Questions 17–20

Choose **TWO** letters, **A–E**.

Questions 17–18

According to the book, which of these **TWO** effects are red and orange believed to have on shoppers?

- A They calm you down.
- B They make you feel energetic.
- C They give you an appetite.
- D They make you feel enthusiastic.
- E They encourage you to spend more

Questions 19–20

Which of these **TWO** colours do people with a limited amount of money respond to the best?

- A light blue D pink
- C orange E red
- B purple

SECTION 3 Questions 21-30

Questions 21–25

What comment do the speakers make about each painkiller?

Choose **FIVE** answers from the box and write the correct letter, **A–F**, next to Questions 1–5.

Common analgesics

- 21 Paracetamol
- 22 Ibuprofen
- 23 Aspirin
- 24 Codeine
- 25 Morphine

Comments

- A** It is considered unsuitable for children.
- B** It is extremely dangerous if you take too much.
- C** It is not as strong as other analgesics.
- D** Its use requires careful monitoring.
- E** It can have slightly unpleasant after effects.
- F** It works at the source of the pain.

Questions 26-30

Complete the flow chart below.

Write **NO MORE THAN TWO WORDS** for each answer.

Aspirin: a brief history

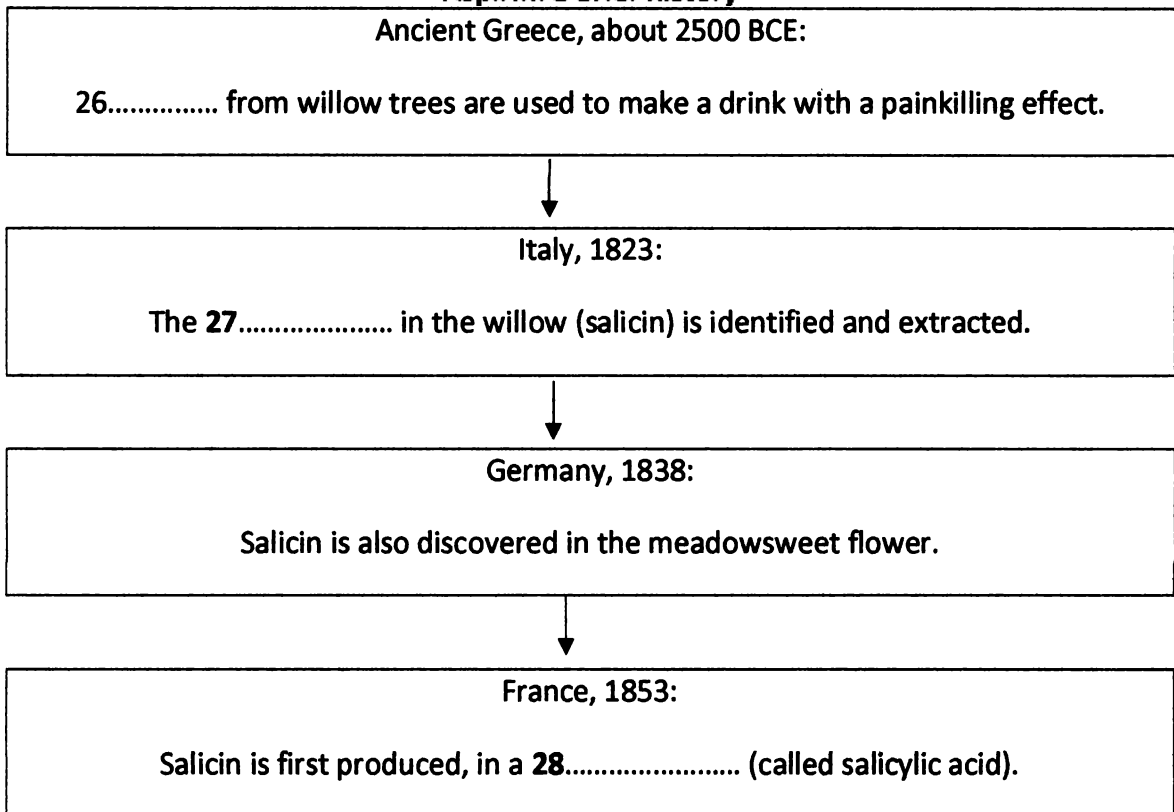

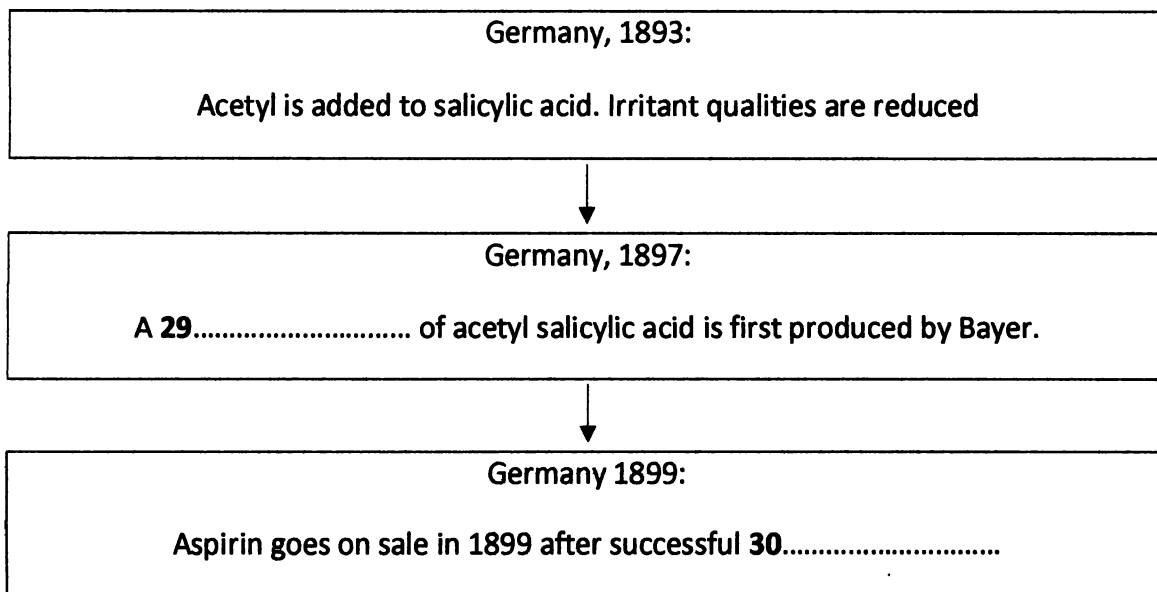

SECTION 4 Questions 31-40

Complete the notes below.

Write **NO MORE THAN TWO WORDS AND/OR A NUMBER** for each answer.

Prehistoric visual art

Cave paintings

What are they?

Paintings in caves or on outdoor surfaces

How old?

Earliest paintings date back about 31.....

Common themes

Animals, humans (and human hands), and 32.....

Common materials

Ochre, manganese, oxide, hematite and other materials with 33..... Charcoal for outlines

Best 34..... paintings are those painted into cut silhouettes.

Possible purpose

Possibly believed to have 35..... (to increase number of animals for food)

Petroglyphs

What are they?

Carved images in 36.....

How old?

From 12,000 years ago until the 20th century

Common themes

Geometric designs, + humans / animals

Purpose

Possibly a kind of language.

Petroglyphs still possess great 37.....

Interesting fact

Designs are universally similar (possibly due to the way the 38..... is formed)



Geoglyphs

What are they?

Drawings or motifs on the ground:

Big: minimum diameter = 39.....

Where found?

Worldwide.

Nazca Lines

Common themes

Creatures such as birds, monkeys, etc. (many 40.....)

TEST 18

SECTION 1 Questions 1-10

Questions 1-5

Choose the correct letter, A, B or C.

1 What does Dave think about Professor Jeffcott?

A He's a typical archaeology lecturer.

B He's very enthusiastic about archaeology.

C He's not as interesting as some archaeology lecturers.

2 What was the first part of Professor Jeffcott's talk about?

A How it's how possible to date Neolithic structures more accurately.

B Artefacts that have been discovered on Neolithic sites.

C What Neolithic structures were used for.

3 According to Professor Jeffcott, most Neolithic structures ...

A were built between two and three thousand years ago.

B were built by people before they moved from one place to another.

C were built during a period of change.

4 What fact about Neolithic people surprised the researchers?

A The kind of food they grew.

B The speed at which they developed new skills.

C The range of skills they had.

5 What is Dave going to do next?

A Study the way prehistoric buildings were built.

B Build a modern structure using prehistoric methods.

C Write an essay on prehistoric building methods.

Questions 6-10

Complete the notes.

Write ONE WORD ONLY for each answer.

The Neolithic period: major events

9,000 – 8,000 years ago

6..... of Neolithic people move around Europe.

8,000 years ago

England and France are 7.....

6,000 – 5,000 years ago

First 8..... Neolithic housing appears.

About 4,500 – 3,000 years ago

Stonehenge built in 9.....
 Pottery made and used for the first time.
 Neolithic people start making 10..... stone implements

SECTION 2 Questions 11-20

Questions 11-22

Complete the notes below.

Write **NO MORE THAN TWO WORDS AND/OR A NUMBER** for each answer.

Internet banking

History

1980s

- Early online banking access required a computer, a monitor and a 11.....
- Very basic. Customers could only:
 - see their 12.....
 - send messages to their bank.
- 13..... were required to move money to other accounts or make bill payments.
- Under one percent of bank customers made use of early online banking

1990s

- Sharp rise in number of 14..... following establishment of Internet.
- Modern online-banking services using web browsers begin.
- Initial consumer reluctance to carry out financial transactions online (15..... from accounts often occurred).
- Changing consumer attitudes prompted by:
 - better 16..... on banking websites
 - more online stores (e.g., Amazon, eBay).

2000+

- 2001: Bank of America = first bank with three million online customers (making three million payments to a value in excess of one 17.....).
- 2012: As many as 18..... of bank customers banking online in one country.
- Many online (internet-only) banks open.

Benefits of internet banking

Customers:

- They gave access to accounts 24/7
- They can make payments (gas, electricity, etc.), move money between accounts, 19....., etc. No need to go to bank.
- They can access banking services using computers or 20.....

Banks:

- Customers keep more money in their account.
- Reduced need for customer 21..... staff.
- Increased customer loyalty (+ more recommendations to others).
- Lower running costs (internet banks only).
- 22..... banks can find customers elsewhere (+ therefore operate beyond their usual area).



SECTION 3 Questions 21-30

Questions 21–25

Complete the sentences.

Write **NO MORE THAN TWO WORDS** for each answer.

- 21 Choose binoculars that are comfortable to carry and have excellent
- 22 Follow the birds the way a would follow them.
- 23 if you can, so the birds don't see you.
- 24 Listen to the noises the bird makes, and observe what it looks like (its, shape, markings and other characteristics).
- 25 Observe movement and flight patterns, and habitat.

Questions 26–28

Label the plan below.

Write the correct letter, **A–G**, next to questions 26–28.

- 26 Goose hide
- 27 Eagle hide
- 28 Cuckoo hide

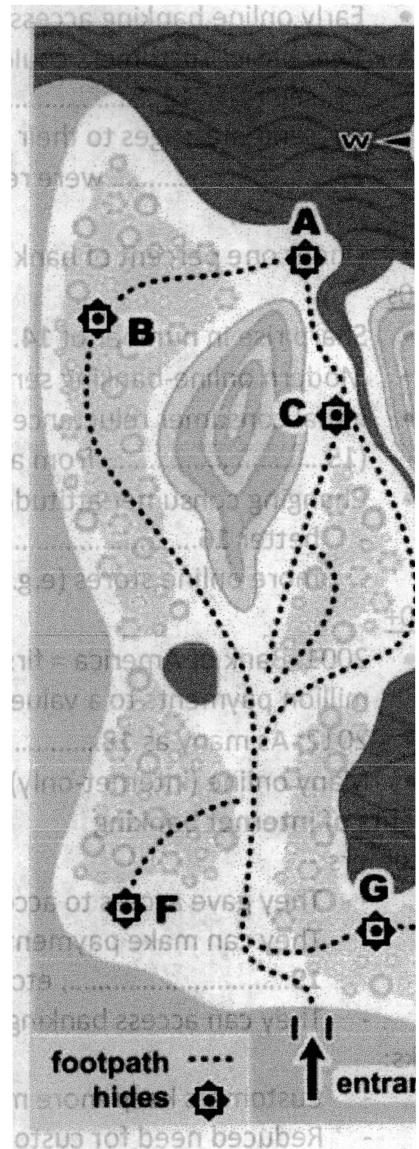

Questions 29-30

Answer the questions.

Write **ONE WORD ONLY** for each answer.

- 29 What, according to the tutor, helps to make bird-watching especially enjoyable?.....
- 30 Apart from binoculars, what should the student take with him?

SECTION 4 Questions 31-40

Complete the notes below.

Write **NO MORE THAN TWO WORDS** for each answer.

Space travel: health issues

Background

Crew on board ISS conduct **31**..... which establish effects of space travel on their bodies

Findings: **32**..... of time in space have a negative impact on human body.

Effects on cardiovascular system

On Earth: human body can regulate **33**..... to compensate for effects of gravity.

In space: Amount and distribution is altered.

Results:

- Cold-like **34**....., including headache and "moon face".
- Space motion sickness (affects roughly **35**..... of space travelers)
Effects soon wear off.

Effects on skeletal structure

Body loses calcium in zero-gravity situations:

Results:

- **36**.....reduced by about:
3.2% after 10 days in space.
2% per month thereafter.
- **37**.....become more likely
Exercise reduces this risk and is also good for preventing loss of **38**.....

Effects of cosmic radiation

Big problem in space – can damage human DNA.

On Earth: people protected by a **39**....., which prevents radiation reaching planet's surface.

In space: **40**..... of cosmic radiation can cause serious illnesses (including cancer, cataracts, brain damage).

TEST 19

SECTION 1 Questions 1-10

Questions 1-10

Complete the form below using **NO MORE THAN TWO WORDS AND/OR A NUMBER** for each answer.

**Ascot Child Care Centre
Enrolment form**

Personal details

Family name:	<i>Cullen</i>
Child's first name:	1
Age:	2
Birthday:	3
Other children in the family:	a brother aged 4
Address:	5, Brisbane
Emergency contact number:	3467 8890

Relationship to child: 6

Development.

- Has difficulty 7 during the day
- Is able to 8 herself

Child-care arrangements

Days required: 9 and

Pick-up time: 10

SECTION 2 Questions 11-20

Complete the notes using NO MORE THAN ONE WORD AND/OR A NUMBER for each answer.

Things to do in the holidays

- Main problem – children do not have a traditional 11

Some ideas

- Give children jobs, for example using the 12
- At home, ask children to help in the 13
- Get children to make 14 ahead of time
- Get children involved in community work such as visiting the 15
- Involve older children in long-term 16 in your community
- You may get some ideas from the 17
- The local 18 is often the best place to find ideas

Things to remember

Make sure children stay 19

Children up to the age of 20 need to be supervised by an adult

SECTION 3 Questions 21-30

Questions 21-24

Choose the correct answer A, B or C.

21 According to John, what is the main advantage of space exploration?

A to supply resources for use on Earth

B to find out more about the origins of our planet

C to establish a colony for humans if Earth becomes uninhabitable

22 According to the speakers, why can't robots be sent into space instead of humans?

A They cannot operate for long enough

B They are too expensive to build

C They are too reliant on humans

23 What are we told about the space technology currently used?

A It can be unreliable

B It is based on old technology

C It is becoming cheaper to produce

24 What is the biggest problem in sending robots to Mars?

A the distance

B the atmosphere

C the extreme temperatures

Questions 25-30

Who expresses the following opinions?

25 We should plan a trip to Mars even though it mayn't happen soon.... **A** John

26 We may eventually colonize Mars....

B Susan

27 The soil on Mars is highly toxic

C Both John and Susan

28 The soil in Mars contains materials we could use

29 Spaceships cannot be totally protected from radiation

30 It is possible that humans could form a base on Mars

SECTION 4 Questions 31-40

Complete the notes below using **NO MORE THAN TWO WORDS AND/OR A NUMBER.**

The history of dentistry

Early history

The earliest reference to problems with teeth was in 31

The ancient Sumerians called problems with teeth 'tooth 32

There is 33 to show that the Chinese used dental treatments

Remedies and treatment

An old text from 34 reveals medical practices from 1700 to 1500 BC. The text refers to the use of 35 and 36 to relieve toothache.

In the fifth century BC a Greek 37 noted the beginnings of specialization in medicine

A Greek doctor was the first to 38 problem teeth.

In Europe during the 39, doctors performed dentistry in people's homes

A dentist from France is said to have founded 40 Dentistry.

TEST 20

SECTION 1 Questions 1-10

Complete the notes below with **NO MORE THAN ONE WORD AND/OR A NUMBER.**

New accommodation

Area 1 Broadgreen

Advantages:

- has several types of 1
- no need to pay for 2
- average rent 3 a week

Disadvantages:

- not many local 4

Area 2 West Derby

Advantages:

- good 5

Disadvantages:

- unlikely to find a 6 in the area
- may be too 7

Contact

John 8

Tel: 9

Arrange appointment for: 10

SECTION 2 Questions 11-20

Complete the notes below.

Write **NO MORE THAN ONE WORD** for each answer.

Past views of intelligence

- Thought to be only one type
- Could be assessed through an IQ test

Current views

- More than one type of intelligence – these can be seen in our **11**
- Howard Gardner – Frames of Mind (1983) identified seven types of intelligence:
 - 1) Linguistic (i.e words and language)
 - 2) **12** (science and maths)
 - 3) Musical
 - 4) Kinesthetic (i.e. the body and **13**
 - 5) Visual (relating to images)
 - 6) Interpersonal (conscious of the **14** of other people)
 - 7) Intrapersonal (relating to self-awareness)
- Other intelligences have been suggested but are not generally included because they are too **15**

Uses in education

- Adapt activities to suit the type of student you are, e.g.
 - a kinesthetic type learner will not learn well from a **16** – they would learn better from taking part in a **17**
 - visual learners could create their own **18**
- Find out the type of learner you are by thinking about the way you prefer to do things, e.g. when teaching someone how to use a new piece of equipment
 - a visual learner would prefer to use a **19**
 - a kinesthetic learner would prefer to do a **20**

SECTION 3 Questions 21-30

Questions 21-27

What benefits do the speakers mention when talking about each of the following genetically modified crops?

Choose **SEVEN** answers from the box and write the correct letter, **A-I**, next to questions 21-27.

Genetically modified crops.

21 maize	Benefits
22 soya beans	A reduction in the use of weedkiller
23 wheat	B not harmful to animals
24 potatoes	C healthier food source
25 rice	D medical uses
26 tomatoes	E less pollution
27 popular trees	F lower water consumption
	G profits for farmers
	H resistant to cold weather
	I cheaper food prices

28 What do the speakers think about the article on genetically modified crops?

- A** It was poorly researched
- B** It was quite biased

C It was out of date

29 What advantage of genetically modified crops did the article stress?

A reduced use of chemicals

B improved soil conditions

C increased profits for farmers

30 What concern do the speakers have about genetically modified foods?

A the impact on our health

B the impact on animals

C the impact on other crops

SECTION 4 Questions 31-40

Complete the table below.

Write **NO MORE THAN TWO WORDS** for each answer.

Teaching physics			
Experiment	Equipment and method	Results	Real world application
Brazil nut effect	<ul style="list-style-type: none"> put a marble and some 31 in a jar and shake 	<ul style="list-style-type: none"> students assume the marble will 32, but the opposite is true 	<ul style="list-style-type: none"> making sure 33 made of powders are accurately mixed
Unpoppable balloon	<ul style="list-style-type: none"> a balloon, a pin and some 34 pierce the balloon with the pin 	<ul style="list-style-type: none"> students believe balloons make a loud noise when the air is 35 there is no loud bang 	<ul style="list-style-type: none"> checking how 36 a material is
Arm 37	a swivel chair and hand weights students hold the weights and spin on the chair they use the weights to control their 38	students can 39 by making themselves narrower	can be seen in 40

TEST 21

SECTION 1 Questions 1-10

Complete the notes below.

Write **NO MORE THAN TWO WORDS AND/OR A NUMBER** for each answer.

Cycling holiday in Australia

Example

Answer

Most suitable holiday lasts **10** days

Holiday begins on **1**

No more than **2** people in cycling group.

Each day, group cycles **3** on average.

Some of the hotels have a **4**

Holiday costs **5** £ per person without flights.

All food included except **6**

Essential to bring a **7**

Discount possible on equipment at www. **8** com

Possible that the **9** may change.

Guided tour of a **10** is arranged.

SECTION 2 Questions 11-20

Questions 11-14

Choose the correct letter, A, B or C.

- 11** The market is now situated
 - A** under a car park.
 - B** beside the cathedral.
 - C** near the river.
- 12** On only one day a week the market sells
 - A** antique furniture.
 - B** local produce.
 - C** hand-made items
- 13** The area is well known for
 - A** ice cream.
 - B** a cake.
 - C** a fish dish.
- 14** What change has taken place in the harbor area?
 - A** Fish can now be bought from the fishermen.
 - B** The restaurants have moved to a different part.
 - C** There are fewer restaurants than there used to be.

Questions 15-20

Which advantage is mentioned for each of the following restaurants?

Choose SIX answers from the box and write the correct letter, A-H, next to questions 15-20.

- 15** Merrivales
 - 16** The Lobster Pot
 - 17** Elliots
 - 18** The Cabin
 - 19** The Olive Tree
 - 20** The Old School Restaurant



Advantages

- A the decoration
- B easy parking
- C entertainment
- D excellent service
- E good value
- F good views
- G quite location
- H wide menu

SECTION 3 Questions 21-30

Questions 21-26

Complete the flow-chart below.

Choose **SIX** answers from the box and write the correct letter, **A-I**, next to questions 21-26

- A actors
- B furniture
- C background
- D costumes
- E local council
- F equipment
- G shooting
- H understudies
- I shopowners

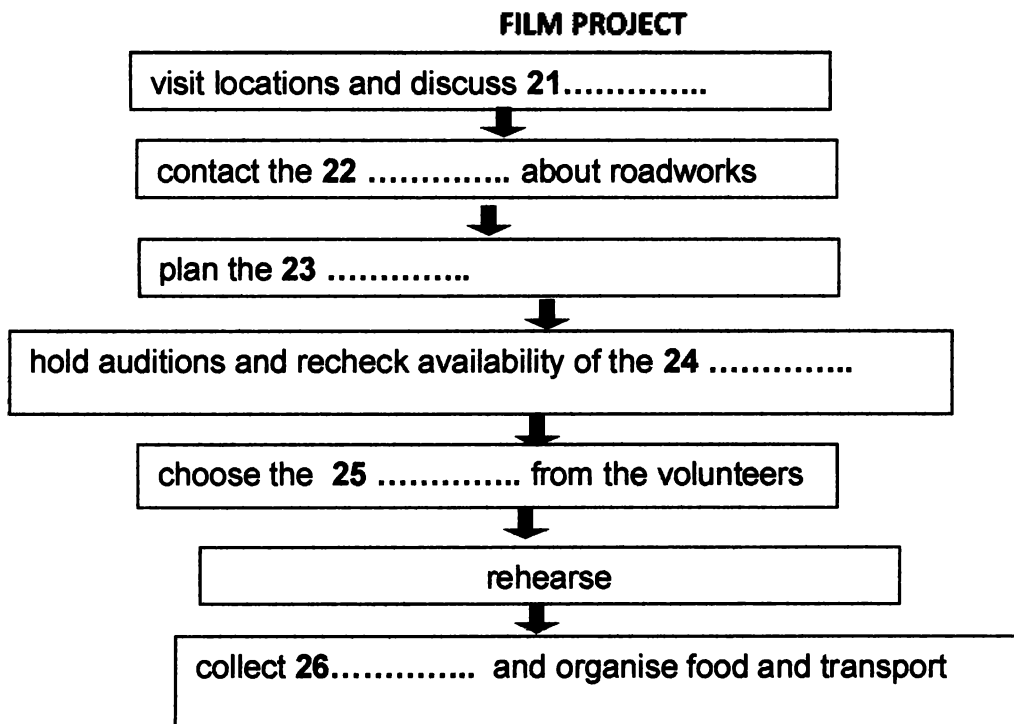



Questions 27-30

Choose four answers from the box and write the correct letter, A-G, next to questions 27-30.

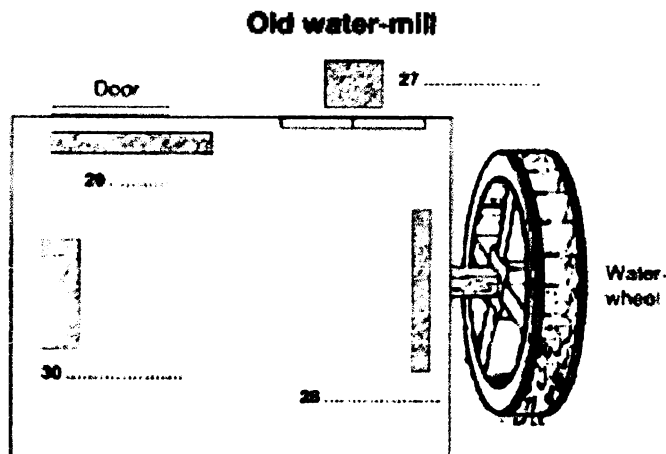

- A lights
- B fixed camera
- C mirror
- D torches
- E wooden screen
- F bike
- G large box

SECTION 4 Questions 31-40

Complete the table below.

Write **NO MORE THAN TWO WORDS** for each answer.

EXOTIC PESTS			
ORIGIN	NAME	New habitat	Notes
Australia	red-backed spider	New Zealand And Japan	even on island in the middle of 31
England	rabbit	Australia	800 years ago: imported into England to be used for 32
America	fire ants	33 in Brisbane	imported by chance
Australia	34	Scotland	deliberately introduced in order to improve 35 (not effective)
New Zealand	flatworm	36 Europe	accidental introduction inside imported 37
Japan	38	Australian Coastal waters	some advantages
Australia	budgerigar	Urban areas of south-east 39	smaller flocks because of arrival of 40 in recent years

TEST 22

SECTION 1 Questions 1-10

Questions 1-6

Complete the table below.

Write **NO MORE THAN TWO WORDS** for each answer.

PRIME RECRUITMENT	
Employee record	
<i>Example</i>	<i>Answer</i>
Surname	<u>Riley</u>
Email	1 @worldnet.com
Nationality	2
Reference (professional)	Name: John Keen Job: manager of 3
Reference (personal)	Name: Eileen Dorsini Job: 4
Special qualifications	current 5 certificate certificate of competence in 6

Questions 7-10

Complete the table below.

Write **NO MORE THAN ONE WORD** for each answer.

PRIME RECRUITMENT CHILDCARE VACANCIES			
Location	Name	Children	Special requirements
London	Benton	girl and boy	be keen on 7
near Oxford	Granger	8 boys	be animal-lover
9	Campbell	four girls	be willing to 10 when camping

SECTION 2 Questions 11-20

Questions 11 and 12

Choose **TWO** letters, **A-E**.

Which **TWO** sources of funding helped build the facility?

A the central government

- B local government
- C a multinational company
- D a national company
- E city residents

Questions 13 and 14

Choose **TWO** letters, **A-E**.

Which **TWO** pre-existing features of the site are now part of the new facilities?

- A football stadium
- B playing fields
- C passenger hall
- D control tower
- E aircraft hangars

Questions 15-20

Label the map below.

Write the correct letter, **A-H**, next to questions 15-20.

- 15 hotel
- 16 transport hub
- 17 cinema
- 18 fitness centre
- 19 shops
- 20 restaurant

Cityscope Sports and Leisure

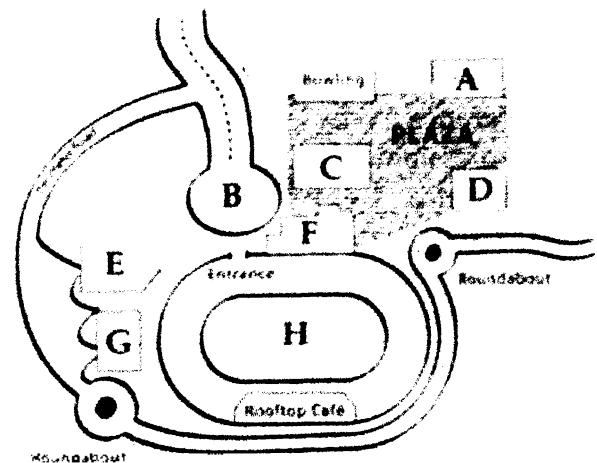

SECTION 3

Questions 21-30

Questions 21-25

Choose the correct letter, **A, B or C**.

- 21 What is Chloe concerned about?
- A her knowledge of math
 - B her ability to write essays
 - C her lack of business experience
- 22 Which of the following does Ivan feel he has improved?
- A his computer skills
 - B his presentation skills
 - C his time management
- 23 What does Chloe especially like about the course?
- A She won't have to do a final examination.
 - B She can spend time working in a business.
 - C She can study a foreign language.
- 24 Ivan is pleased that the university is going to have
- A more lecture rooms.
 - B a larger library.

- C more courses.
 25 What does Ivan advise Chloe to do?
 A contact his tutor
 B read about some other universities
 C visit the university

Questions 26-30

What does the Chloe decide about the following subjects?
 Write the correct letter, A, B or C, next to the questions 26-30.

Subjects

- 26 Public relations
 27 Marketing
 28 Taxation
 29 Human resources
 30 Information systems

A she will study it
 B she won't study it
 C she might study it

SECTION 4 Questions 31-40

Questions 31-35

Complete the notes below. Write **NO MORE THAN TWO WORDS** for each answer.

History of weather forecasting

Early methods

- Almanacs connected the weather with the positions of different
 31..... at particular times

Invention of weather instruments

- A hygrometer showed levels of 32..... (Nicholas Cusa 1450)
- Temperature variations first measured by a thermometer containing
 33..... (Galileo Galilei 1593)
- A barometer indicated air pressure (Evangelista Torricelli 1643)

Transmitting weather information

- The use of the 34..... allowed information to be passed around the world
- Daily 35..... were produced by the French from 1893

Questions 36-40

Complete the sentences below.
 Write **NO MORE THAN TWO WORDS** for each answer.

Producing a weather forecast

36 Weather observation stations are found mostly at around the country.
 37 Satellite images use the colour orange to show
 38 The satellites give so much detail that meteorologists can distinguish aparticular
 39 Information about the upper atmosphere is sent from instrumentsattached to a
 40 Radar is particularly useful for following the movement of

TEST 23

SECTION 1 Questions 1-10

Complete the notes below.

Write **NO MORE THAN TWO WORDS AND/OR A NUMBER** for each answer.

Midbury Drama Club

Background

Example	Answer
club started in	<u>1957</u>

- prize recently won by **1** section
- usually performs **2** plays

Meetings

- next auditions will be on Tuesday, **3**
- help is needed with **4** and
- rehearsals take place in the **5** hall
- nearest car park rehearsals is in Ashburton Road opposite the **6**

Costs

- annual membership fee is **7** £
- extra payment for **8**

Contact

- secretary's name is Sarah **9**
- secretary's phone number is **10**

SECTION 2 Questions 11-20

Questions 11-15

Choose the correct letter, **A**, **B** or **C**.

11 What does the charity *Forward thinking* do?

- A** It funds art exhibitions in hospitals.
- B** It produced affordable materials for art therapy.
- C** It encourages the use arts projects in healthcare.

12 What benefit of *Forward thinking's* work does Jasmine mention?

- A** People avoid going to hospital.
- B** Patients require fewer drugs.
- C** Medical students do better in tests.

13 When did the organization become known as *Forward thinking*?

- A** 1986
- B** in the 1990s
- C** 2005

14 Where does *Forward thinking* operate?

- A** within Clifton city.
- B** in all parts of London.
- C** in several towns and villages near Clifton.

15 Jasmine explains that the Colville Centre is

- A** a school for people with health problems.
- B** a venue for a range of different activities.



C a building which needs repairing.

Questions 16-20

Who can take part in each of the classes?

Write the correct letter A, B or C next to questions 16-20.

- 16 Learn Salsa
- 17 Smooth Movers
- 18 Art of the Forest
- 19 The Monkey Maze
- 20 Make a Play

Class participants
A children and teenagers
B adults
C all ages

SECTION 3 Questions 21-30

Questions 21-26

Complete the flow-chart below.

Choose **SIX** answers from the box and write the correct letter, **A-I**, next to questions 21-26

- A air quality
- B journey times
- C land use
- D leisure facilities
- E means of transport
- F parking facilities
- G number of pedestrians
- H places of employment
- I traffic flow

CITY CENTRE FIELD TRIP

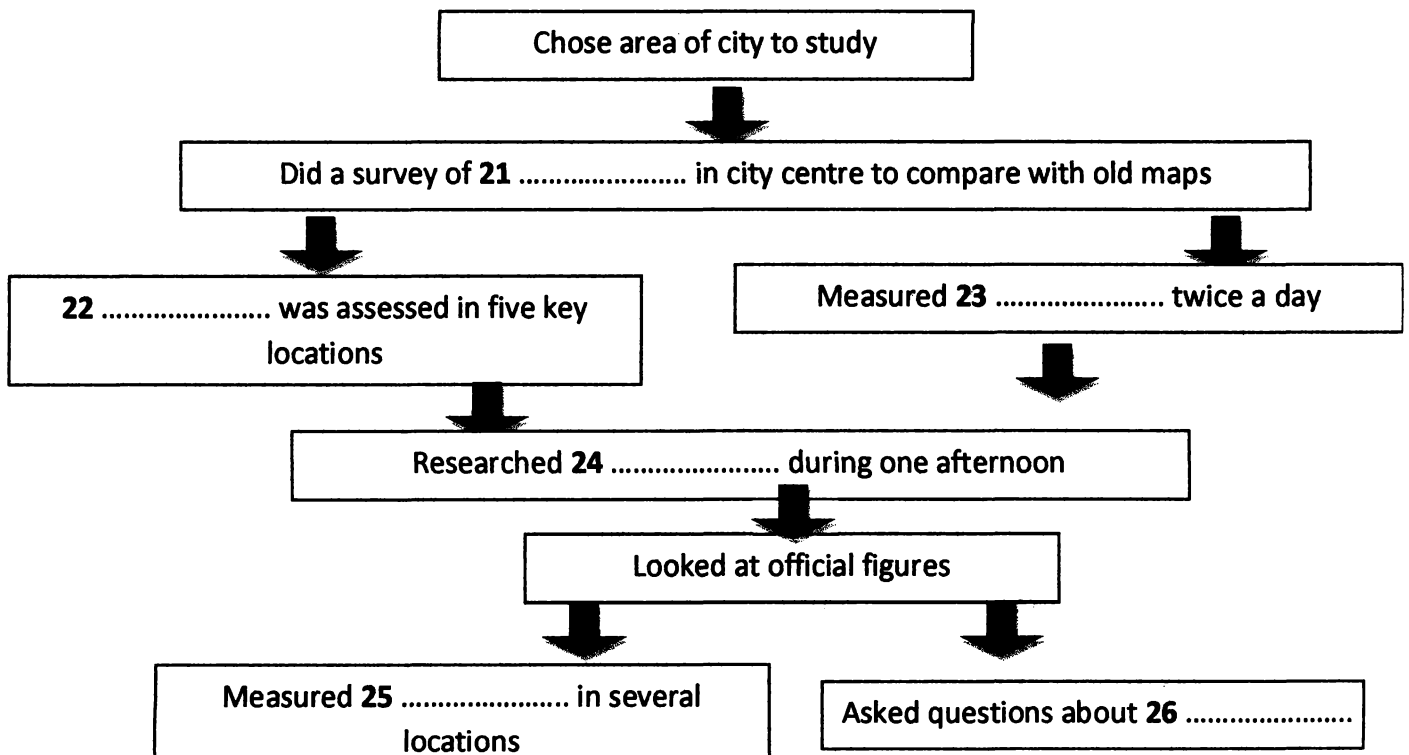



Questions 27-30

Who will be responsible for each task?

Write the correct letter next to questions 27-30.

- 27 draw graphs and maps
- 28 choose photographs
- 29 write report
- 30 do presentation

- A Stefan
- B Lauren
- C Both Stefan and Lauren

SECTION 4 Questions 31-40

Questions 31-35

Complete the form below.

Write **ONLY ONE WORD** for each answer.

Manufacturing in the English Midland

- 31 In the eighteenth century, the still determined how most people made a living.
- 32 In the ground were minerals which supported the many of the region.
- 33 Since the late sixteenth century the French settlers had made
- 34 In Cheshire was mined and transported on the river Mersey.
- 35 Potters worked in a few situated on the small hills of North Staffordshire.

Questions 36-40

Complete the form below.

Write **ONE WORD** for each answer.

Pottery notes

Earthenware

advantages:

- potters used **36** day
- saved money on **37**

disadvantages:

- needed two firings in the kiln to be **38**
- fragility led to high **39** during manufacturing

Stoneware

- more expensive but better
- made from a **40** of clay and flint

TEST 24

SECTION 1 Questions 1-10

Complete the form below.

Write **ONE WORD AND/OR a NUMBER** for each answer.

MEGEQUIP CUSTOMER DETAILS

Example	Answer
Order	<u>winter</u> catalogue
Name	1 Greening
Address	2 York Terrace
Delivery address	5, York 3
Payment method	4 in advance
Reason for discount	address within the 5

Questions 6-10

Complete the form below.

Write **ONE WORD AND/OR a NUMBER** for each answer.

MEGAQUIP CUSTOMER ORDER				
Item	Catalogue no.	Catalogue section	Colour	Delivery notes
desk lamp	664	6	slate	customer will 7
chair	131	Home Office	8	our van
filling cabinet two drawers with 9	153	Commercial	grey	direct from London no later than 10

SECTION 2 Questions 11-20

Questions 11 and 12

Choose **TWO** letters, A-E

Which **TWO** things make the museum unusual?

- A the guides
- B the events
- C the animals
- D the buildings
- E the objects

Questions 13 and 14

Choose **TWO** letters, A-E

Which **TWO** things can visitors do at the museum?

- A buy home-made bread
- B ride a horse
- C ride on a tram
- D buy copies of original posters
- E go down a coal mine

Questions 15 and 20

Label the map below.

Write the correct letters, A-I, next to questions 15-20.

- 15 The exhibition centre
- 16 The High Street
- 17 The farmhouse
- 18 The coal mine
- 19 The Manor House
- 20 The Railway Station

Brampton open-air museum

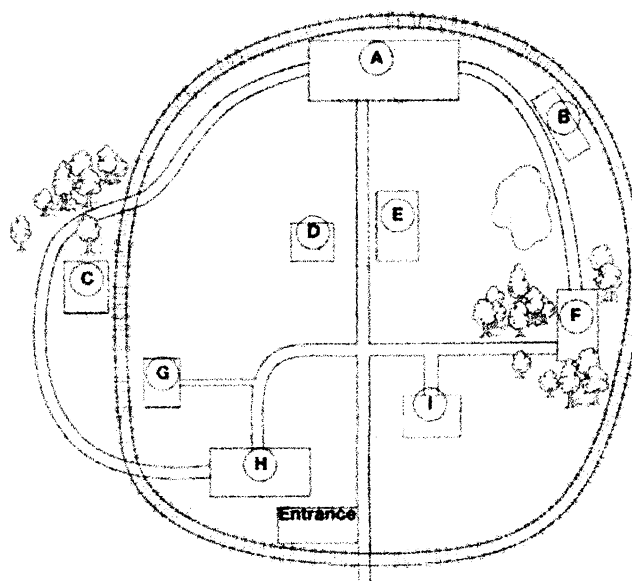



SECTION 3 Questions 21-30

Questions 21-26

Which attitude is associated with the following people during the conversation?

Choose **SIX** answers from the box and write the correct letter, **A-H**, next to questions **21-26**.

People

- 21 Cressida's fellow students
- 22 Cressida
- 23 Ainsley Webb
- 24 Dr Erskine
- 25 Professor Jenkins
- 26 TV news centre staff

Attitudes

- A amused
- B critical
- C forgetful
- D impatient
- E polite
- F relaxed
- G sympathetic
- H unrealistic

Questions 27-30

Choose the correct letter, **A, B** or **C**.

- 27 What was Cressida asked to do at the beginning of her placement?
 - A go out to buy things for the production team
 - B run errands to other parts of the TV news centre
 - C meet visitors and escort them to the studio
- 28 What was fortune for Cressida?
 - A She was familiar with a piece of equipment.
 - B She spent a lot of time in the editing suite.
 - C She was given a chance to interview someone.
- 29 What does Cressida feel she needs to improve?
 - A her understanding of business
 - B her organizational skills
 - C her ability to work in a team
- 30 What has given her an idea for her final assignment?
 - A a meeting with a public relations professional
 - B seeing a political speaking to an audience
 - C a disagreement with one of the TV presenters

SECTION 4 Questions 31-40

Complete the form below.

Write **NO MORE THAN TWO WORDS** for each answer

THE HISTORY OF THE ELECTRIC GUITER			
DATE	MAKER	NAME OF GUITER	FEATURES
1890s	Orville Gibson	no name	similar in shape to a 31.....
1925	John Dopyera	The National Guitar	made of metal, good for playing 32 music
1930s	C.F. Martin Company	The Dreadnought	strings made of 33



1931	George Beauchamp	The 34	used two of 35 shaped like horseshoes
1935	Adolph Rickenbacker	The Rickenbacker Electro Spanish	made from 36
1941	Les Paul	The Log	the first to be completely 37
1950	Leo Fender	The Fender Broadcaster	its simplicity made it ideal for 38
1951	Leo Fender	The 39	easy to carry around
1952	Ted McCarty	The Gibson Les Paul	40in colour
1954	Leo Fender	The Fender Stratocaster	double cutaway design

TEST 25

SECTION 1 Questions 1-10

Complete the form below.

Write **NO MORE THAN TWO WORDS AND/OR A NUMBER** for each answer.

Costwise Car Hire

Example

Answer

Number of offices in Sydney:**3**.....

Booking reference number: **1**

Office just by **2** terminal.

Opening hours: **3** to

After-hours charge: **4** \$

Cheapest model of car available: **5**

Information needed when booking: **6** number

Length of hire period: **7**

Reduced cost by driving under **8** km per week.

Insurance does not cover: **9**

After hours put keys in box near the office on the **10**

SECTION 2 Questions 11-20

Questions 11-15

The following are essential requirements for which jobs?

Write the correct letter, **A, B or C**, next to questions 11-15.

- 11** conference organizer
- 12** catering manager
- 13** housekeeper
- 14** fitness centre staff
- 15** reservation assistant

Essential requirements	
A	foreign languages
B	willingness to travel abroad
C	professional qualification

Questions 15-20

Choose **FIVE** answers from the box and write the correct letter, **A-G**, next to question 16-20

- A CV
- B names of referees
- C work permit
- D recruitment seminar
- E evidence of qualifications
- F conditions of employment
- G initial interview

**INTERNATIONAL FINEST GROUP
RECRUITMENT PROCEDURES**

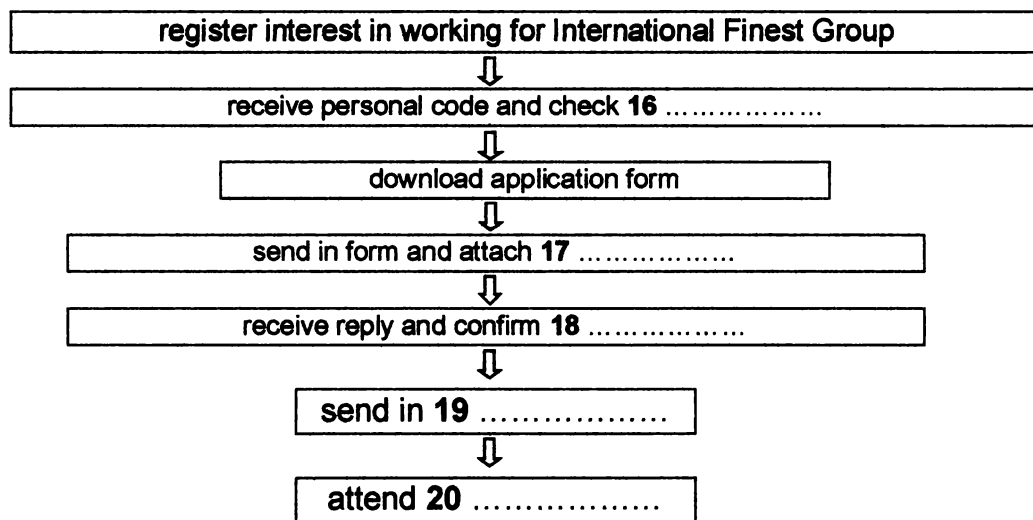

SECTION 3

Questions 21-30

Questions 21-22

Choose **TWO** letters, A-E

Which **TWO** possible objections to a roof garden are discussed?

- A problems of access
- B the cost of construction
- C the time needed to install it
- D who will look after it
- E how to support the weight of it

Questions 23-24

Choose **TWO** letters, A-E.

Which **TWO** recent developments in roof-garden building are mentioned?

- A waterproof barrier materials
- B drainage system
- C tank designs
- D lightweight construction materials
- E watering system

Questions 25-30

Label the diagram below.

Write the correct letter, A-H, next to question 25-30.



- 25 wall
- 26 electric wire
- 27 fibre optic cable
- 28 wooden post
- 29 glass cap
- 30 acrylic rod

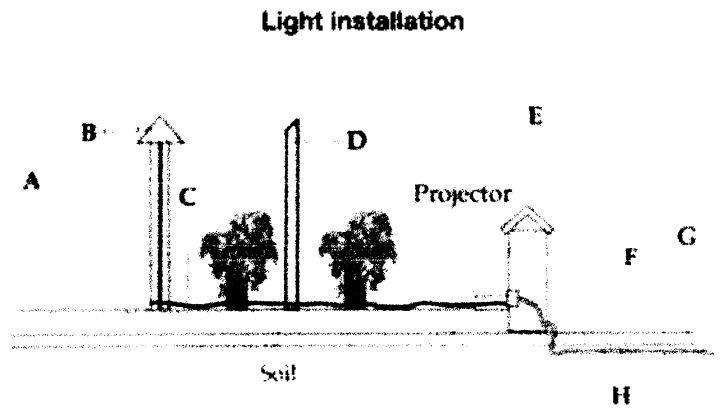

SECTION 4 Questions 31-40

Questions 31 -36

Complete the form below.

Write **NO MORE THAN TWO WORDS** for each answer.

The Argus system

Developed by Rob Holman in N. Carolina with other researches.

Research is vital for understanding of 31 Matches information from under the water with information from a 32 According to S. Jeffers Williams, useful because can make observation during a 33

Dr Holman's sand collection

Dr H. has samples from every 34

Used in teaching students of 35

e.g. US East Coast display:

grains from south are small, light-coloured and 36 in shape

Questions 37-40

Complete the flow-chart below.

Write **NO MORE THAN THREE WORDS** for each answer.

Taking samples when travelling

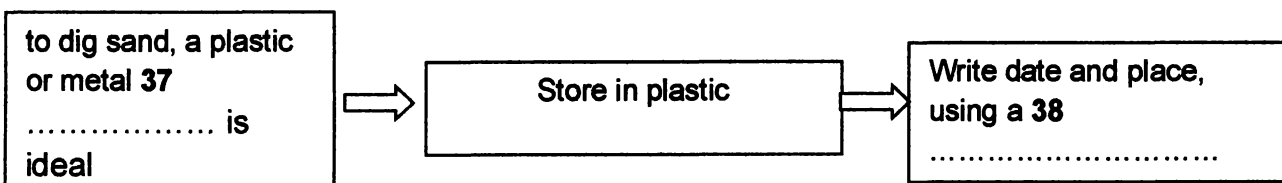

After reaching home

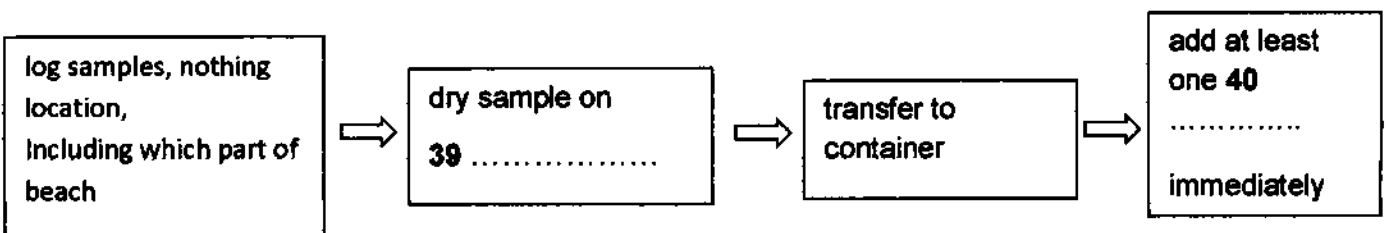



TEST 26

SECTION 1 Questions 1-10

Complete the table below.

Write **ONE WORD AND/ OR A NUMBER** for each answer.

HOSTELS			
Name	Location	Cost of double room	Notes
Hosteling International West End	<p><i>Example</i> 10 minutes</p> <p>from downtown by</p> <p>Answer <u>bus</u></p>	\$50 per night but only 1\$ for members	Membership card offers discount on entry to 2 Internet access cost \$: per 3
4 Hostel	Near beach. Two-minute walk to 5	\$62. Meals extra but only available in 6	Was built as a hotel in Can hire 8 From hostel
Backpackers Hostel	In 9 district	\$45 plus \$ for breakfast	A 10 on every floor for guests to use

SECTION 2 Questions 11-20

Questions 11-15

Label the map below.

Choose **FIVE** answers from the box and write the correct letter, **A-H**, next to questions **11-15**.

- A biography
- B fiction
- C magazines
- D newspapers
- E non-fiction
- F photocopyers
- G reference books
- H study area

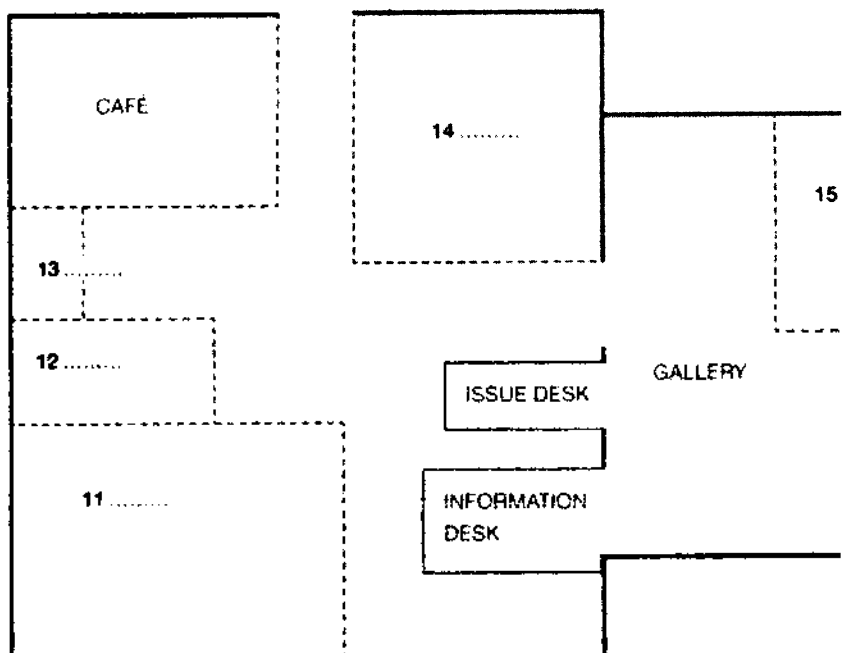

Questions 16-20

Choose the correct letter, A, B or C.

- 16** After two correct letter, A, B or C.
A show proof of their current address.
B pay for a new membership card.
C bring a passport or identity card into the library.
- 17** What happens if you reserve a book?
A It will be available after five days.
B You can collect it a week later.
C You will be contacted when it is available.
- 18** Which materials can be borrowed for one week only?
A some reference books
B CD-ROMs
C children's DVDs
- 19** On which day does the library stay open later than it used to?
A Wednesday
B Saturday
C Sunday
- 20** Large bags should be left on the
A first floor.
B second floor.
C third floor.

SECTION 3 **Questions 21-30**

Questions 21-25

Choose the correct letter, A, B or C.

- 21** Why did Anita and Lee choose to talk about John Chapman?
A He was Lee's childhood hero.
B They wanted to talk about the USA.
C He was relevant to the topic of their studies.
- 22** Where did the students record their sources of information?
A on their laptops
B on a handout
C on a database
- 23** The tutor claims she does not understand whether
A apples grew in America before Europeans arrived.
B the Native Americans had always eaten apples.
C American apples were first bred in Europe.
- 24** The tutor says the audience was particularly interested to hear about
A grafting techniques in ancient China.
B the cultivation of apples in Kazakhstan.
C the spread of apples along the Silk Route.
- 25** How will Anita and Lee present their follow-up work?
A on the department website
B as a paper
C as a poster

Questions 26-30

What do Lee and Anita agree about their presentation skills with their tutor?

What the correct letter, **A, B or C**, next to questions 26-30.

- A** excellent
- B** acceptable
- C** poor

Presentation skills

- 26** use of equipment
- 27** handing software
- 28** timing of section
- 29** design of handout
- 30** clarity of speech

SECTION 4 Questions 31-40

Complete the table below.

Write **NO MORE THAN ONE WORD** for each answer.

INVESTIGATING TASTE		
Procedure	Result	Cause
more yellow added to green colour of 31	subjects believed extra 32 added to drink	brain influenced by product presentation
gum chewed until it is 33 then again with sugar	mint flavor 34	sweetness necessary for mintiness
some drink tasted cold and at room temperature	35 drink seems sweeter	temperature affects sweetness
crisps eaten in rooms which were 36	with louder crunch, subjects believed crisps taste 37	sound affects taste perceptions
variety of cheese sauces	subjects believed some sauces tasted less strong	38 affects taste perceptions
two different flavoured 39 tasted together	subjects still tasted 40 when no longer there	brain is filling the taste 'gap'

TEST 27

SECTION 1 Questions 1-10

Questions 1-4

Complete the table below.

Write **NO MORE THAN THREE WORDS AND/OR A NUMBER** for each answer.

Diyorbek's IELTS

University clubs	Monday	Tuesday	Wednesday
Name of club	<i>film</i>	<i>climbing</i>	<i>chess</i>
Extra activities	<i>discussions</i>	1	2
Current number of members	3	40	55
Contact	<i>Events organizer</i>	4	<i>Maths tutor</i>

Questions 5-10

Complete the notes below.

Write **NO MORE THAN THREE WORDS** for each answer.

Details of climbing club:

5 meets

6 excursion to France in the

7 subscriptions paid

Benefits:

8 discounts on

9 annual

10 free entrance to climbing in Cardiff

SECTION 2 QUESTIONS 11-20

Questions 11-15

Which features are available at the following halls of residence?

Choose **FIVE** answers from the box and write the correct letter **A-G** next to Questions 11-15.

- List of features**
- A cleaning included
 - B all meals included
 - C private showers
 - D modern building
 - E parking spaces
 - F single sex
 - G sports facilities

- Halls of Residence**
- 11 Brown Hall
 - 12 Blake Residence
 - 13 Queens Building
 - 14 Parkway Flats
 - 15 Temple Rise

Questions 16-20

Label the map below.

Write the correct letter **A-G** next to Questions 16-20.

16 Brown Hall

17 Blake Residence

18 Queens Building

19 Parkway Flats

20 Temple Rise

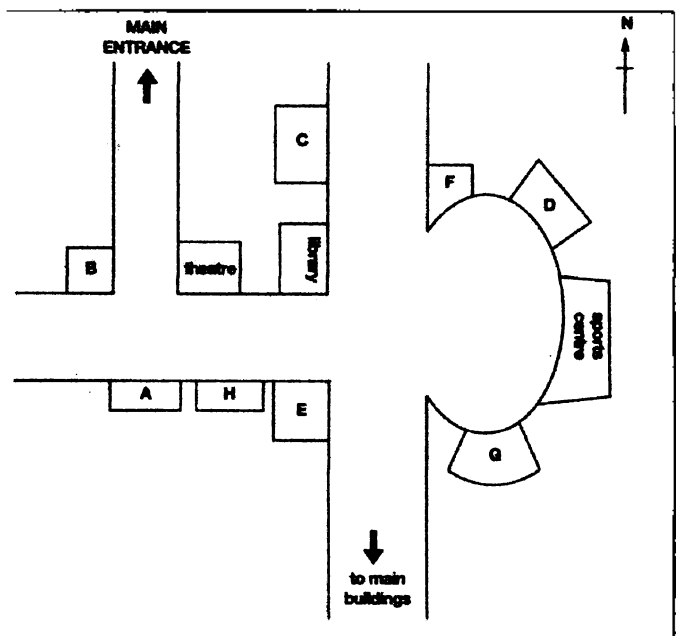

SECTION 3 QUESTIONS 21-30

Questions 21-24

Complete the sentences below.

Write **NO MORE THAN THREE WORDS OR A NUMBER** for each answer.

21 Jenna and Marco must complete their project by

22 The project will be a study of the increase in

23 The project will be assessed by

24 Jenna and Marco agree they need a for the project.

Questions 25-27

Choose **THREE** letters, A-G.

What **THREE** things do Marco and Jenna have to do now for the project?

- A interview some people
- B hand out questionnaires
- C choose their subjects
- D take photographs
- E use statistical software
- F do some work in the library
- G contact some local companies

Questions 28-30

Choose the correct letter, A, B or C.

28 Why did Jenna and Marco agree to work together?

- A because they both wanted to work with someone else
- B because they each have different skills
- C because they have worked together before

29 Why does Marco suggest that he writes the analysis?

- A He needs more practice with this kind of writing
- B He is better at English than Jenna.
- C He has more experience of this than Jenna.

30 Why does Jenna offer to do the presentation?

- A Her tutor wants her to do the presentation.
- B Marco is very nervous about giving presentations.
- C She wants to divide the work on the project fairly.

SECTION 4 QUESTIONS 31-40

Questions 31-35

Of which US news source is each of the following statements true?

Write the correct letter, **A**, **B** or **C** next to Questions 31-35.

31 It is more popular at the weekend than during the week.

32 It has affected the popularity of local radio.

33 It has recently been able to expand internationally.

34 It is offering more varied reporting than previously.

35 It has suffered from government intervention.



Questions 36-40

Complete the summary below.

Write **NO MORE THAN TWO WORDS** for each answer.

Advertising and Newspapers

In the USA, newspapers are being increasingly inventive about the way they attract advertisers and their **36** now exceeds that of other industries. Advertising has increased because of a good relationship with the **37** sector. In addition, newspapers now run more adverts which include **38** These have been found to raise the readership of the papers and create more sales for the **39**..... There are also an increasing number of more expensive **40** adverts.

TEST 28

SECTION 1 Questions 1-10

Questions 1-6

Complete the forum below.

Write **NO MORE THAN TWO WORDS AND/OR A NUMBER** for each answer.

Student Union Registration Form

Name: Stefan Unger

Degree programme: 1

Department: 2.....

Leisure activities: 3

Language(s) apart from English: 4

Type of accommodation: 5

Contact number: 6

Questions 7-10

Answer the questions below.

Write **NO MORE THAN THREE WORDS** for each answer.

7 When can students use the photocopier?

8 Where are events usually held?

9 Which Union officer is responsible for van hire?

10 What will Union members be able to get a discount on?

SECTION 2 QUESTIONS 11-20

Questions 11-15

Label the map below. Choose **FIVE** answers from the box and write the correct letter A-G next to Questions 11-15.



- A Arts section
- B Computers
- C Language section
- D Law
- E Magazines
- F Science
- G study desks

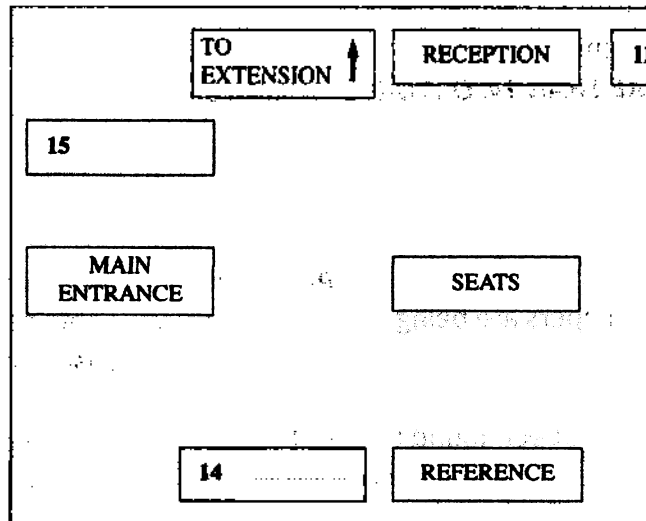

Questions 16-20

Complete the notes below.

Write **NO MORE THAN TWO WORDS AND/OR A NUMBER** for each answer.

Library system:

Maximum borrowing period: **16**

Renew books in person or by **17**

Overdue charge: **18**

Unavailable books: complete **19**

Extra services: **20**

SECTION 3 QUESTIONS 21-30

Questions 21-24

Complete the flow-chart below.

Write **NO MORE THAN TWO WORDS** for each answer.

To Submit a Paper for the Architecture Conference

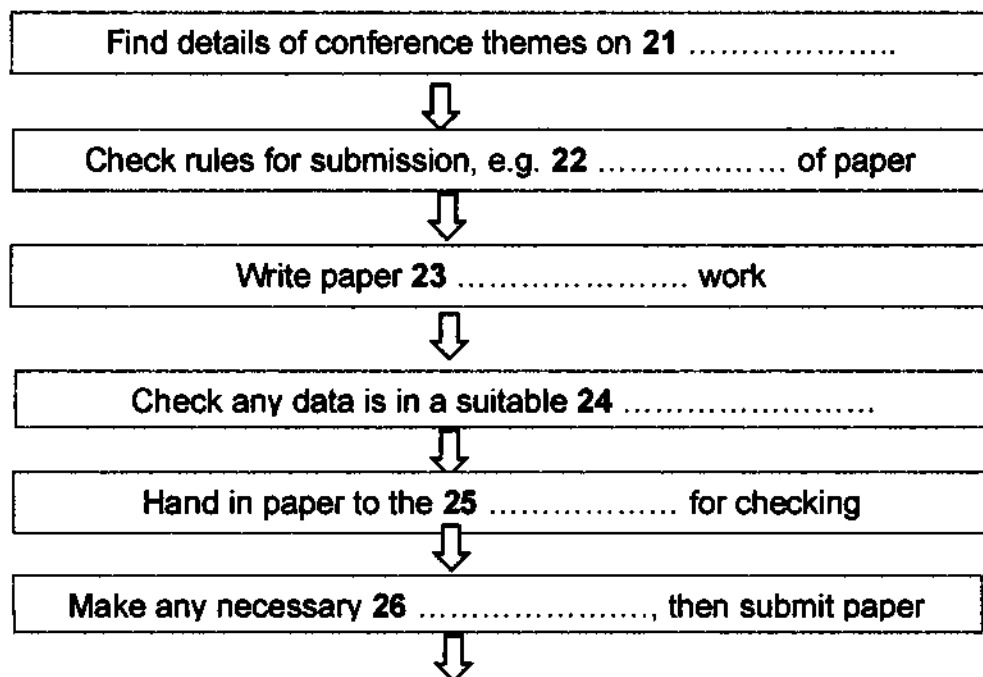

If accepted, send in details of your 27 requirements



Send conference organisers a personal profile for the 28

Questions 29 and 30

Choose **TWO** letters, **A-E**.

Which **TWO** things does Kristen plan to do to prepare her conference paper?

- A** read another student's thesis
- B** collect more data
- C** talk to some postgraduates
- D** contact a Professor at another university
- E** inspect a building site

SECTION 4 QUESTIONS 31-40

Questions 31-35

Complete the sentences below.

Write **NO MORE THAN TWO WORDS** for each answer.

Mobile phones now have the technology to

- send **31** of where the sender is
- watch **32** in real time
- send **33** with texts
- inform students about lectures which are **34**
- transfer **35** to a computer

Questions 36-40.

Which group of people are the main users of mobile phones for the following papers?

Write the correct letter, **A, B** or **C** next to Questions 36-40.

- A** women
- B** men
- C** men and women

Ways of Using Mobile Phones

- 36** to access information
- 37** to stay in touch
- 38** for business
- 39** to store personal brands
- 40** as a camera



TEST 29

SECTION 1 Questions 1-10

Questions 1-7

Complete the notes below.

Write **NO MORE THAN THREE WORDS AND/OR A NUMBER** for each answer.

<p style="text-align: center;">Courses Available</p> <p>writing in first term</p> <p>1 in second term</p> <p>2 throughout the year</p> <p>3 during long vacation</p> <p>Class sizes: 4 maximum</p> <p>Course costs often paid by the 5.....</p> <p>Exams available in 6</p> <p>Must enroll by 7</p>
--

Questions 8-10

Choose **THREE** letters, A-G.

Which **THREE** items does the student need to bring to the first class?

- A passport
- B computer disk
- C note from tutor
- D notebook
- E student identity card
- F dictionary
- G registration form

SECTION 2 QUESTIONS 11-20

Questions 11-15

Of which types of transport is the following true?

Write the correct letter, **A, B** or **C** next to Questions **11-15**.

Features of Transport

- 11 cheapest
- 12 most convenient
- 13 most comfortable
- 14 fastest
- 15 most frequent service

A tube
B train
C bus

Questions 16-20

Label the map below.

Write the correct letter, **A-G**, next to Questions 16-20.



	New features	Size	Problems
transport	individual transportation	roads will be narrower	levels of investment
commercial areas	roofs will have 31	32 of current area	33 will be limited to outskirts
residential areas	homes made of 34	will be limited to 15,000	providing enough housing fo 35
energy sources	36 will be an energy source	energy plants will be smaller	noise and congestion caused by 37

Questions 38-40.

Answer the questions below.

Write **NO MORE THAN TWO WORDS** for each answer.

Which three types of accommodation does the speaker say will increase in city centres?

38

39

40

TEST 30

SECTION 1 Questions 1-10

Questions 1-4

Complete the form below.

Write **NO MORE THAN THREE WORDS AND/OR A NUMBER** for each answer.

DVD Customer Profile

Occupation student

Have you owned a DVD player before? No

What is the maximum you want to spend on a DVD player? **1**

How often do you watch DVDs? **2**

What type of films do you enjoy? **3**

What other DVDs (non-film) do you watch? **4**

Questions 5-10

Complete the table below.

Write **NO MORE THAN TWO WORDS AND/OR A NUMBER** for each answer.

Player	Features	Cost	After-sales service
DB 30	basic	£69	5 Only
XL 643	Can also 6	7	8 at reduced cost
TriX	Will also play 9	£94 including 10	Guaranteed for 3 years

SECTION 2 QUESTIONS 11-20

Questions 11-20

Complete the sentences below.

Write **NO MORE THAN THREE WORDS** for each answer.

Your home:

11 A quarter of break-ins are through the

12 The of the house should be protected.

13 You should warn burglars your house is alarmed by putting a in the window.

The alarms:

- 14 The alarms show a constant
- 15 The alarms can be set off by a
- 16 The alarms are connected to the

Installation:

- 17 The alarms are usually installed in
- 18 The security code should be kept
- 19 The alarms can be installed at an additional cost.
- 20 Customers can pay for their alarm system.

SECTION 3 QUESTIONS 21-30

Questions 21-27

Complete the summary below.

Write **ONE WORD ONLY** for each answer.

Essay Writing

Essay writing is simply the process of 21 information and presenting your 22 You will need to use skills of analysis, 23 and expression. The more essays you write, the more you will develop these skills. The key to producing a good essay is in the 24..... Allow plenty of time to work out what you need to do. You will find several books in the library to help you with the particular 25 of academic writing. When you have completed your essay you must remember to 26 it carefully and take out anything irrelevant. Also, once you have received your mark, you should check your essay through as, by doing this, you can 27 from it.

Questions 28-30.

Choose **THREE** letters, **A-G**.

Which **THREE** pieces of advice does the tutor give the student?

- A break the question down into smaller questions
- B check the vocabulary in the question
- C limit how much you read
- D make sure you have good notes
- E use only a few questions
- F ask a friend to read your essay
- G try to be objective

SECTION 4 QUESTIONS 31-40

Questions 31-36

Complete the flow-chart below.

Write **ONE WORD ONLY** for each answer.

Exchange Rate Project

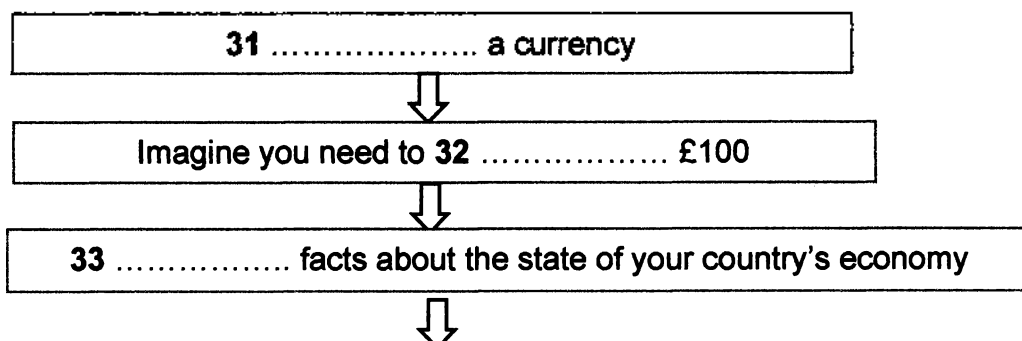

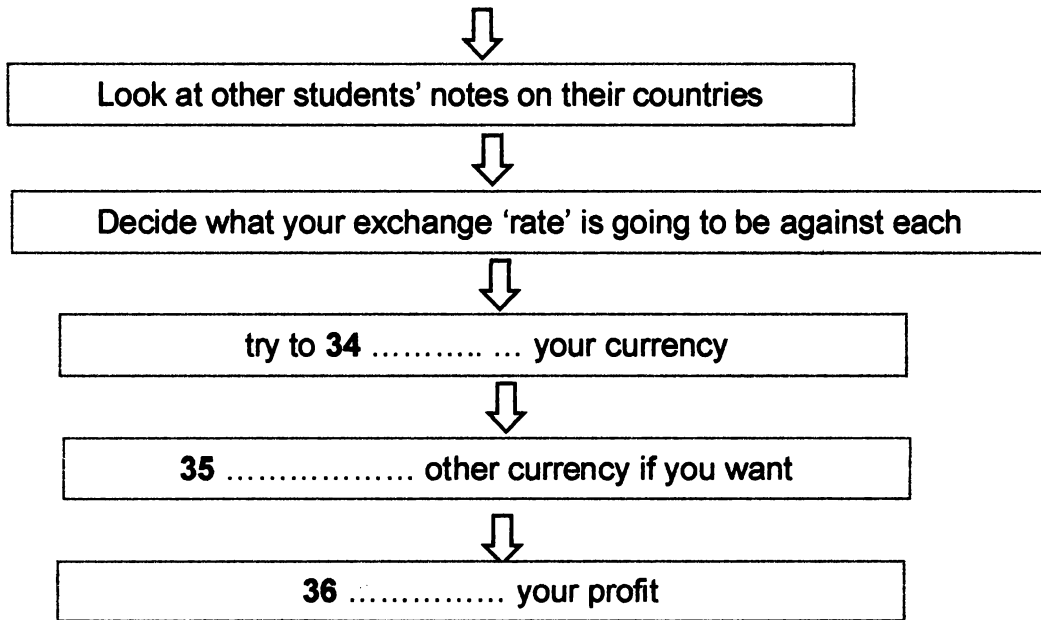

Questions 37-40

Answer the questions below.

Write **NO MORE THAN THREE WORDS AND/OR A NUMBER** for each answer.

- 37 How many main trading partners does the UK have?
- 38 Which sector does the tutor want students to study?
- 39 What does the tutor want students to look at changes in?
- 40 When does the tutor want the project completed by?

TEST 31

SECTION 1 Questions 1-10

Questions 1-3

Listen to the telephone conversation between a student and the owner of a paragliding school and answer the questions below.

Circle the correct letters, A-D.

Example

Which course does the man suggest?

- A 2 day C 5 day
B 4 day D 6 day

1 How much is the beginner's course?

- A \$190
B \$320
C \$330
D \$430

2 What does the club insurance cover?

- A injury to yourself
B injury to your equipment
C damage to other people's property
D loss of personal belongings



SECTION 3 Questions 21-30

Complete the notes below.

Write **NO MORE THAN THREE WORDS** for each answer.

Research details:

Title of project: **21**

Focus of project: entertainment away from **22**

Questions 23-26

Circle the correct letters A-C.

23 Which chart shows the percentage of cinema seats provided by the different cinema houses?

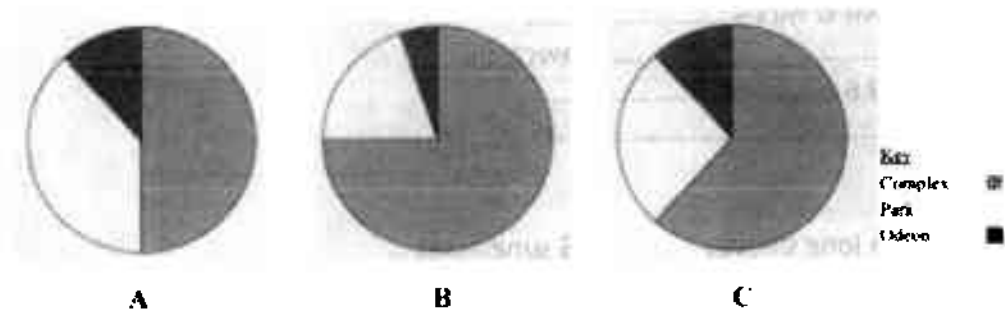

24 Which graph shows the relative popularity of different cinemas?

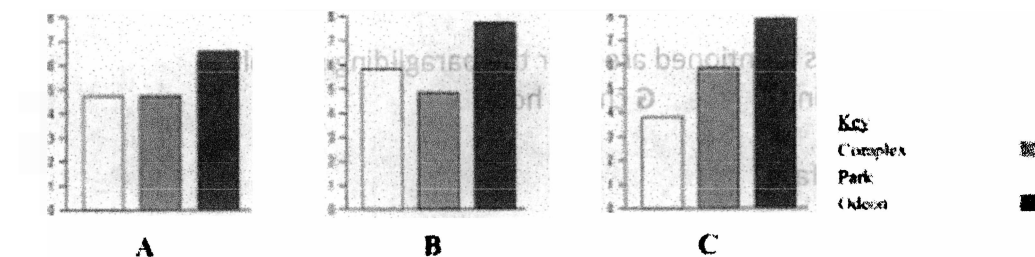

25 What did Rosie and Mike realize about the two theatres?

- A The prices were very similar
- B They were equally popular
- C They offered the same facilities

26 Which graph shows comparative attendance for cinema and theatre?

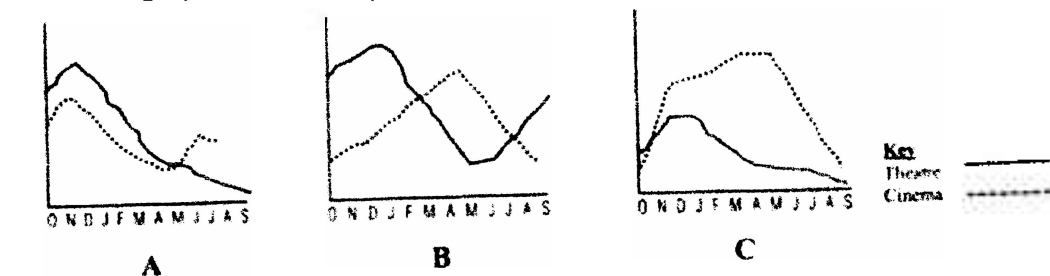

Questions 27-30

Complete the chart about the different music clubs below.

Write **NO MORE THAN TWO WORDS** or use **ONE** of the symbols for each answer.



✗ poor ✓ OK ✓✓ excellent

Club	Type of music	Quality of venue
The Blue Club	Blues	27
The Sansue	28	✓✓
Pier Hotel	Folk	29
Baldrock Café	Rock	30

SECTION 4 Questions 31-40

Questions 31-32

Complete the notes using **NO MORE THAN THREE WORDS** for each answer.

Main focus of lecture: the impact of 31 on the occurrence of dust storms

Two main types of impact:

- a) break up ground surface, e.g. off-road vehicle use
- b) remove protective plants, e.g. 32 and

Questions 33-36

Complete the table using **NO MORE THAN THREE WORDS** for each answer.

Name of area	Details
USA 'dust bowl'	Caused by mismanagement of farmland Decade renamed the 33
West Africa	Steady rise in dust storms over 20-year period
Arizona	Worst dust clouds arise from 34 Dust deposits are hazardous to 35
Sahara	Increased wind erosion has occurred along with long-term 36

Questions 37-40

Complete the flow chart using **NO MORE THAN THREE WORDS** for each answer.

Drying-up of Aral Sea

Intensive 37 in Central Asian Republics
Drop ↓ water in major tributaries
Total volume of water in lake reduced by 38
Increase ↓ wind-blown material
Lake has become more 39
Serious effects on 40 nearby



TEST 32

SECTION 1 Questions 1-10

Questions 1-4

Circle the correct letters A-C.

Example

Which course is the man interested in?

A English

B Mandarin

C Japanese

1 What kind of course is the man seeking?

A Daytime

B Evenings

C Weekends

2 How long does the man want to study?

A 12 weeks

B 6 months

C 8 months

3 What proficiency level is the student?

A Beginner

B Intermediate

C Advanced

4 When does the man want to start the course?

A March

B June

C September

Questions 5-10

Complete the form.

Write NO MORE THAN THREE WORDS for each answer.

Language Centre

Client Information Card

Name: Richard 5

E-mail address: 6@hotmail.com

Date of birth: 7 1980

Reason for studying Japanese: 8

Specific learning needs: 9

Place of previous study (if any): 10

SECTION 2 Questions 11-20

Questions 11-12

Complete the sentences below.

Write NO MORE THAN THREE WORDS for each answer.

11 The story illustrates that dogs are animals

12 The people of the town built a of a dog.



Questions 13-20

Complete the table below.

Write **NO MORE THAN THREE WORDS** for each answer.

TYPE OF WORKING DOG	ESSENTIAL CHARACTERISTICS FOR THE JOB	ADDITIONAL INFORMATION
Sheep dogs	Smart, obedient	Herd sheep and 13 them
Guide dogs	Confident and 14	Training paid for by 15
Guard dogs and 16 and dogs	Tough and courageous	Dogs and trainers available through 17
Detector dogs	Need to really 18	In Sydney they catch 19 a month
Transport dogs	Happy working 20	International treaty bans huskies from Antarctica

SECTION 3 Questions 21-30

Questions 21-23

Complete the notes below.

Write **NO MORE THAN THREE WORDS** or **A NUMBER** for each answer.

Braille – a system of writing for the blind

- Louis Braille was blinded as a child in his **21**
- Braille invented the writing system in the year **22**
- An early writing system for the blind used embossed letters
- A military system using dots was called **23**

Questions 24-27

Circle the correct letters A-C.

24 Which diagram shows the Braille positions?

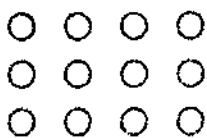

A



B



C

25 What can the combined dots represent?

- A both letters and words
- B only individual words
- C only letters of the alphabet

26 When was the Braille system officially adopted?

- A as soon as it was invented
- B two years after it was invented
- C after Louis Braille had died

27 What is unusual about the way Braille is written?

- A It can only be written using a machine

- B The texts have to be read backwards
- C Handwritten Braille is created in reverse

Questions 28-30

List **THREE** subjects that also use a Braille code.
Write **NO MORE THAN ONE WORD** for each answer.

- 28
- 29
- 30

SECTION 4 Questions 31-40

Complete the notes below.
Write **NO MORE THAN THREE WORDS** or **A NUMBER** for each answer.
Question: Can babies remember any **31**

Experiment with babies:

Apparatus: baby in cot
colorful mobile
some **32**

Re-introduce mobile between one and **33** Later

Table showing memory test results

Baby's age	Maximum memory span
2 months	2 days
3 months	34
21 months	Several weeks
2 years	35

Questions 36-40

Research questions: Is memory linked to **36** development?
Can babies **37** their memories?

Experiment with other children:

Stages in incident: a) lecture taking place
b) objects fall over
c) **38**

Table showing memory test results

Age	% remembered next day	% remembered after 5 months
Adults	70%	39
9-year-olds	70%	Less than 60%
6-year-olds	Just under 70%	40

Diyorbek's IELTS



San Gett	Just past 'Tip of Caln'	15 Beach on island	Check 16 On beach in rough weather
Blanaka	17 Corner	Surrounded by 18	Can go caving and diving
Dissidor	Close to Blanaka	Need to walk over 19	Need to take some 20 and

SECTION 3 Questions 21-30

Complete the notes below.

Write **NO MORE THAN THREE WORDS or A NUMBER** for each answer.

Procedure for Bookshops

Keep database of course/college details

In May, request 21 from lectures

Categorize books – as essential reading

22 Reading

Background reading

When ordering refer to last year's 23

- Type of course
- Students' 24
- Own judgement

Procedure for Publishers

Send 25 to course providers

Use websites

Compose personal 26 to academic staff

Send 27 Bookstores

Students

Main objective is to find books that are good 28

Also look for books that are 29 and 30

SECTION 4 Questions 31-40

Question 31

Circle the correct letters A-C

31 At the start of her talk Rebecca points out that new graduates can find it hard to

- A get the right work
- B take sufficient breaks
- C motivate themselves

Question 32-33

Circle **TWO** letters A-E.

Which **TWO** of the following does Rebecca say worry new artists?

- A earning enough money
- B moving to a new environment
- C competing with other artists
- D having their work criticized

E getting their portfolios ready

Questions 34 and 35

Circle the correct letters A-C.

34 Rebecca decided to become an illustrator because it

A afforded her greater objectivity as an artist

B offered her greater freedom of expression

C allowed her to get her work published

35 When she had developed a portfolio of illustrations, Rebecca found publishers

A more receptive to her work

B equally cautious about her work

C uninterested in her work

Questions 36-40

Complete the notes below.

*Write **NO MORE THAN THREE WORDS** for each answer.*

Suggestions for Developing a Portfolio

Get some artwork printed in magazines by entering **36**

Also you can **37** and mock up book pages.

Make an effort to use a variety of artistic **38**

Aim for recognition by dividing work into distinct **39**

Possibly use **40**

TEST 34

SECTION 1 Questions 1-10

Complete the notes below.

*Write **NO MORE THAN THREE WORDS** or **A NUMBER** for each answer.*

EVENT DETAILS

Type of event: *Example* Dragon Boat Race

Race details

Day & date: 1

Place: Brighton 2

Registration time: 3

Sponsorship

- aim to raise over 4 as a team and get a free t-shirt
- free Prize Draw for trip to 5

Team details

- must have crew of 20 and elect a 6
- under 18s need to have 7 to enter
- need to hire 8
- advised to bring extra 9
- must choose a 10 for the team

SECTION 2 Questions 11-20

Questions 11-15

Complete the notes below.

Use **NO MORE THAN THREE WORDS** for each answer.

KIWI FACT SHEET

Pictures of kiwis are found on **11** and

The name kiwi comes from its **12**

The kiwi has poor sight but a good **13**

Kiwis cannot **14**

Kiwis are encouraged by **15**

Questions 16-17

Complete the notes below.

Use **NO MORE THAN THREE WORDS** for each answer.

Kiwi Recovery Program

Stage of Program	Program Involves
16	Looking at kiwi survival needs
Action	Putting science into practice
17	Schools and the website

Questions 18-20

Complete the flow chart below.

Use **NO MORE THAN THREE WORDS** or **A NUMBER** for each answer.

OPERATION NEST EGG

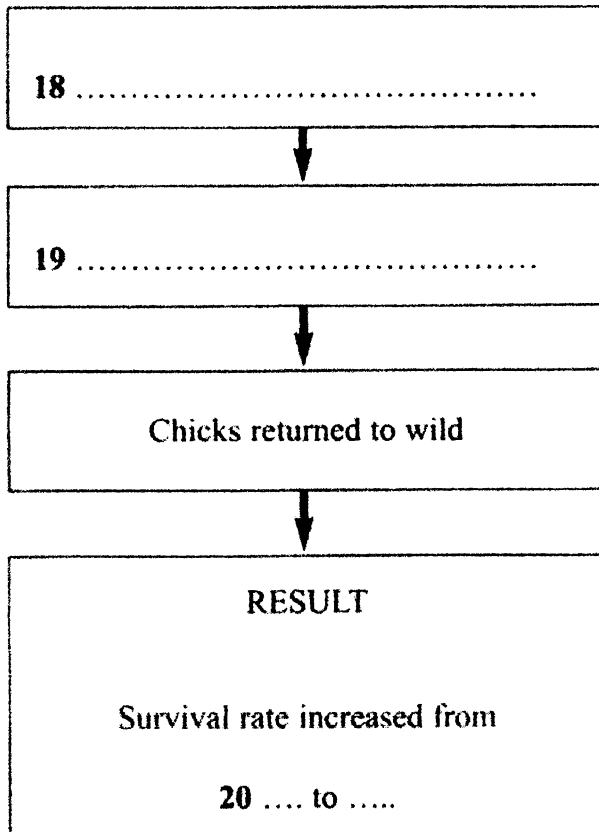



SECTION 3 Questions 21-30

Questions 21-24

Circle the correct letters A-C.

21 The professor says that super highways

A lead to better lifestyles

B are a feature of wealthy cities

C result in more city suburbs

22 The student thinks people

A like the advantages of the suburbs

B rarely go into the city for entertainment

C enjoy living in the city

23 The professor suggests that in five years' time

A City Link will be choked by traffic

B public transportation will be more popular

C roads will cost ten times more to build

24 The students believes that highways

A encourage a higher standard of driving

B result in lower levels of pollution

C discourage the use of old cars

Questions 25-26

Label the two bars identified on the graph below.

Choose your answers from the box and write them next to Questions 25-26.

Percentage of people using public transport by capital city

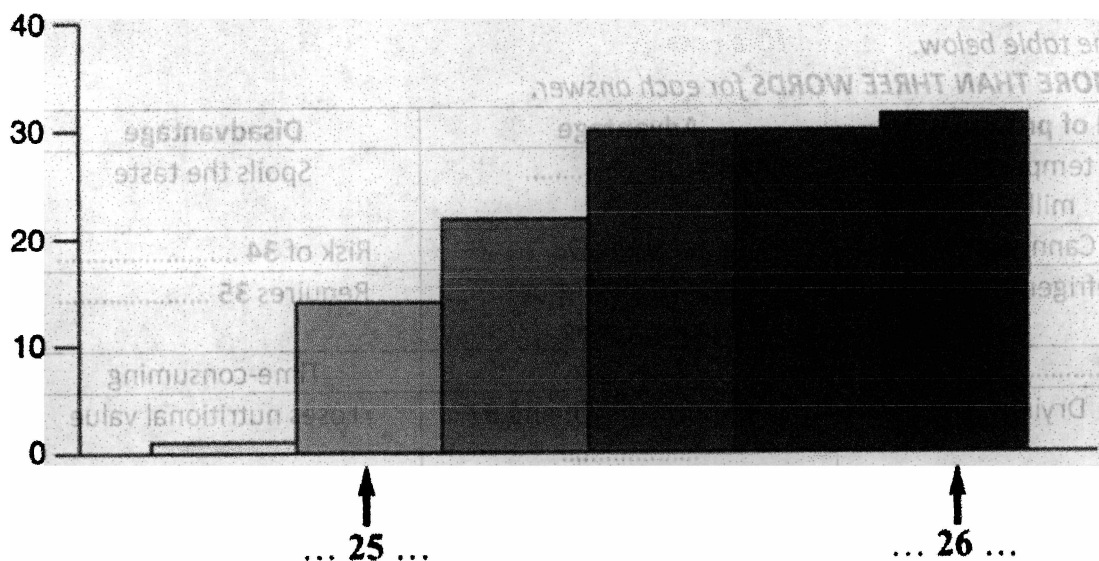

List of cities: Detroit

Frankfurt

London

Paris

Sydney

Toronto

Questions 27-28

Circle **TWO** letters A-F

Which **TWO** facts are mentioned about Copenhagen?



- A live street theatre encouraged
- B 30% of citizens walk to work
- C introduction of parking metres
- D annual reduction of parking spots
- E free city bicycles
- F free public transport

Questions 29-30

Circle **TWO** letters A-F

Which **TWO** reasons are given for the low popularity of public transport?

- A buses slower than cars
- B low use means reduced service
- C private cars safer
- D public transport expensive
- E frequent stopping inconvenient
- F making connections takes time

SECTION 4 Questions 31-40

Questions 31-32

Complete the notes below.

Write **NO MORE THAN THREE WORDS** for each answer.

Reasons for preserving food

- Available all year
- For **31**
- In case of **32**

Questions 33-37

Complete the table below.

Write **NO MORE THAN THREE WORDS** for each answer.

Method of preservation	Advantage	Disadvantage
Ultra-high temperature (UHT milk)	33	Spoils the taste
Canning	Inexpensive	Risk of 34
Refrigeration	Stays fresh without processing	Requires 35
36	Effective	Time-consuming
Drying	Long-lasting, light and 37	Loses nutritional value

Questions 38-40

Label the diagram.

Write **NO MORE THAN THREE WORDS** for each answer.

Roller drying

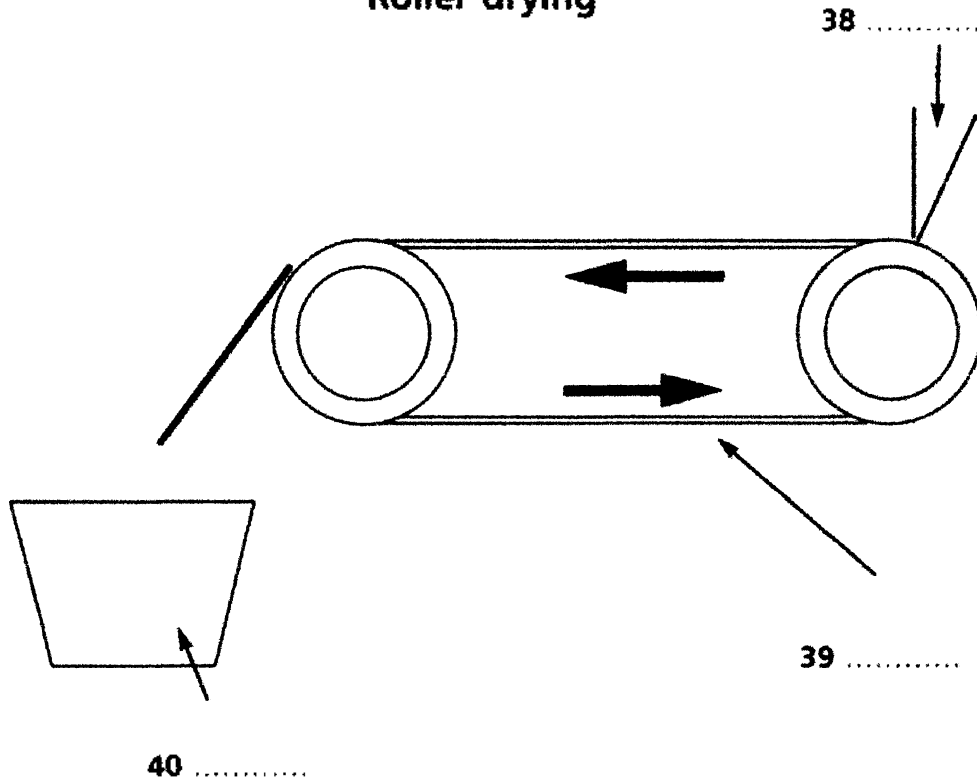

TEST 35

SECTION 1 Questions 1-10

Questions 1-6

Complete the form below.

Write **NO MORE THAN THREE WORDS or A NUMBER** for each answer.

**Millenium Office Supplies
CUSTOMER ORDER FORM**

Example

Order placed by *John Carter*

ACCOUNT NUMBER 1

COMPANY NAME 2

Envelopes

Size **A4 normal**

Colour 3

Quantity 4

Photocopy paper

Colour 5

Quantity 6

Questions 7-9

List **THREE** additional things that the man requests.

Write **NO MORE THAN THREE WORDS** for each answer.

7

8

9

Question 10

Complete the notes below.

Write **NO MORE THAN THREE WORDS** for your answer.

Special instructions: Deliver goods **10**

SECTION 2 Questions 11-20

Complete the notes below.

Write **NO MORE THAN THREE WORDS** for each answer.

Artist's Exhibition

General details:

Place: **11** No. **1** **12**

Dates: 6th October – **13**

Display details:

- Jewellery
- Furniture
- Ceramics
- **14**
- Sculpture

Expect to see: crockery in the shape of **15**
 silver jewellery, e.g. large rings containing **16**
 A shoe sculpture made out of **17**

Go to demonstrations called: **18**

Artist's Conservatory

Courses include: Chinese brush painting
19

Silk painting

Fees include: Studio use
 Access to the shop
 Supply of **20**

SECTION 3 Questions 21-30

Questions 21-13

Complete the sentences below.

Write **NO MORE THAN THREE WORDS** for each answer.

According to Alison Sharp...

- 21** Bear ancestors date back years
22 Scientists think bears were originally in the family as
23 The Cave Bear was not dangerous because it

Questions 24-28

Complete the grid. Tick (✓) the relevant boxes in each column.

Bear species	Sloth Bear	Giant Panda	Polar Bear	Black Bear	Brown Bear	Sun Bear
24 Which is the most recent species?						
25 Which is the largest looking bear?						
26 Which is the smallest bear?						
27 Which bear eats plants?						
28 Which bear eats insects						

Questions 29-30

Circle **TWO** letters A-F.

Which **TWO** actions are mentioned to help bears survive?

- A breeding bears in captivity
- B encouraging a more humane attitude
- C keeping bears in national parks
- D enforcing international laws
- E buying the speaker's book
- F writing to the United Nations

SECTION 4 Questions 31-40

Questions 31-36

Circle the correct letters A-C.

31 The speaker compares a solar eclipse today to a

- A religious experience
- B scientific event
- C popular spectacle

32 The speaker says that the dark spot of an eclipse is

- A simple to predict
- B easy to explain
- C randomly occurring

33 Concerning an eclipse, the ancient Chinese were

- A fascinated
- B rational
- C terrified

34 For the speaker, the most impressive aspect of an eclipse is the

- A exceptional beauty of the sky
- B chance for scientific study
- C effect of the moon on the sun



35 Eclipses occur rarely because of the size of the

- A moon
- B sun
- C earth

36 In predicting eclipses, the Babylonians were restricted by their

- A religious attitudes
- B inaccurate observations
- C limited ability to calculate

Questions 37-40

Complete the table below.

Write **NO MORE THAN THREE WORDS** for each answer.

Date of eclipse	Scientists	Observation
1715	Halley	37 who accurately predicted an eclipse
1868	Janssen and Lockyer	Discovered 38
1878	Watson	Believed he had found 39
1919	Einstein	Realized astronomers had misunderstood 40

TEST 36

SECTION 1 Questions 1-10

Questions 1-9

Complete the notes below.

Write **NO MORE THAN THREE WORDS AND/OR A NUMBER** for each answer.

ENQUIRY ABOUT BOOKCASES

Example	Answer
Number of bookcases available	two

Both bookcases

Width: 1

Made of: 2

First bookcase

Cost: 3

Colour: 4

Number of shelves: six (four are 5))

Second bookcase

Colour: dark brown

Other features

- almost 80 years old
- has a 6 at the bottom
- has glass 7

Cost: 8

Details of seller

Name: Mrs 9



Address: 41 Oak Rise, Stanton

Question 10

Choose the correct letter, A, B or C.

Which map shows the correct location of the seller's house?

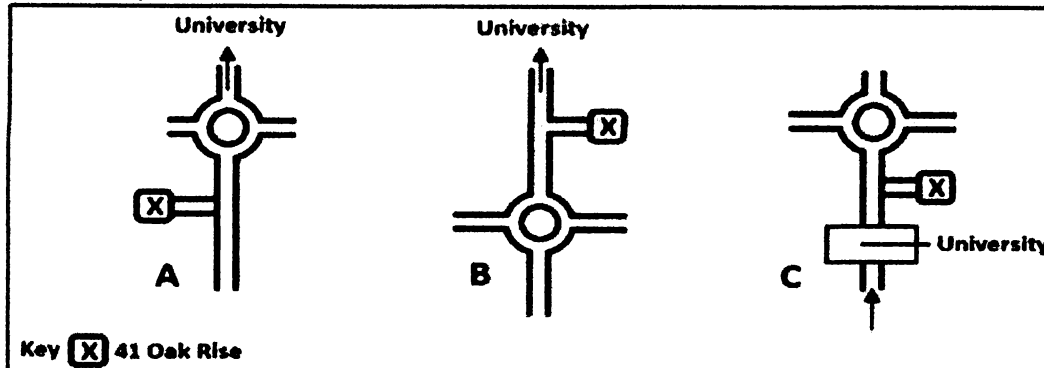

SECTION 2 Questions 11-20

Questions 11-13

Complete the summary below.

Write **NO MORE THAN THREE WORDS AND/OR A NUMBER** for each answer.

Charity Art Sale

The paintings will be displayed in the Star Gallery and in a nearby **11** The sales of pictures will begin at **12**..... on Thursday, and there will be refreshments beforehand. The money raised will all be used to help **13** children in New Zealand and other countries.

Questions 14-20

Complete the table below.

Write **NO MORE THAN THREE WORDS** for each answer.

Artist	Personal information	Type of painting
Don Studley	<ul style="list-style-type: none"> • Daughter is recovering from a problem with her back • Self-taught artist 	Pictures of the 14New Zealand
James Chang	<ul style="list-style-type: none"> • Originally from Taiwan • Had a number of 15 there 	<ul style="list-style-type: none"> • 16 paintings • Strong colours
Natalie Stevens	<ul style="list-style-type: none"> • Has shown pictures in many countries • Is an artist and a website 17 	<ul style="list-style-type: none"> • Soft colours, various media • Mainly does 18
Christine Shin	<ul style="list-style-type: none"> • Lived in New Zealand for 19 • Korean 	<ul style="list-style-type: none"> • Paintings are based on 20



		<ul style="list-style-type: none"> • Watercolors of New Zealand landscapes
--	--	---

SECTION 3 Questions 21-30

Questions 21-25

What instructions were the students given about their subject?

Write the correct letter, A, B or C next to Questions 21-25.

21 Choose a writer from a list provided

22 Get biographical information from the internet

23 Study a collection of poems

24 Make a one-hour video

25 Refer to key facts in the writer's life

- A they must do this
- B they can do this if they want to
- C they can't do this

Questions 26-30

Complete the notes below.

*Write **NO MORE THAN THREE WORDS** for each answer.*

Other requirements for the project

- extract chosen from the author's work must reflect the 26 and of the author
- students must find sound effects and 27 to match the texts they choose
- students must use a 28 of computer software programs to make the video
- students must include information about the 29 of all material

Criteria for assessment

- Completion of all components – 25%
- 30 (must represent essence of author's work) – 50%
- Artistic and technical design of video – 25%

SECTION 4 Questions 31-40

Questions 31-33

Choose the correct letter, A, B or C.

31 'Extremophiles' are life forms that can live in

- A isolated areas
- B hostile conditions
- C new habitats

32 The researchers think that some of the organisms they found in Antarctica are

- A new species
- B ancient colonies
- C types of insects

33 The researchers were the first people to find life forms in Antarctica

- A in the soil
- B under the rock surface
- C on the rocks

Questions 34-40

Complete the sentences below.

*Write **ONE WORD** for each answer.*

How the extremophiles survive

- 34 Access to the sun's heat can create a for some organisms
- 35 The deeper the soil, the higher the of salt.
- 36 Salt can protect organisms against the effects of, even at very low temperatures.
- 37 All living things must have access to water
- 38 Salt plays a part in the process of, which prevents freezing.
- 39 The environment of is similar to the dry valleys of Antarctica.
- 40 This research may provide evidence of the existence of extraterrestrial life forms and their possible on other planets.

TEST 37

SECTION 1 Questions 1-10

Questions 1-3

Choose the correct letter, A, B or C.

Example:

Martin wants to

- A sell a flat
- B rent a flat
- C buy a flat

1 What is Martin's occupation?

- A He works in a car factory
- B He works in a bank
- C He is a college student

2 The friends would prefer somewhere with

- A four bedrooms
- B three bedrooms
- C two bathrooms

3 Phil would rather live in

- A the east suburbs
- B the city centre
- C the west suburbs

Questions 4-10

Complete the table below.

Write **NO MORE THAN THREE WORDS AND/OR A NUMBER** for each answer

Details of flats available

Location	Features	Good (✓) and bad (✗) points
Bridge Street, near the 4.....	<ul style="list-style-type: none"> • 3 bedrooms • very big living room 	<ul style="list-style-type: none"> ✓ 5 £a mont ✓ transport links ✗ no shower ✗ could be 6.....
7.....	<ul style="list-style-type: none"> • 4 bedrooms • living room • 8..... 	<ul style="list-style-type: none"> ✓ 9.....and well equipped ✓ shower ✓ will be 10..... ✗ £800 a month

SECTION 2 Questions 11-20

Questions 11-15

Complete the sentences below.

*Write **NO MORE THAN THREE WORDS** for each answer.*

The British Library

11 The reading rooms are only open for group visits on..... .

12 The library was officially opened in

13 All the library rooms together cover m².

14 The library is financed by the

15 The main function of the library is to provide resources for people doing

Questions 16-20

Label the plan below.

*Write **NO MORE THAN THREE WORDS** for each answer.*

Plan of the British Library

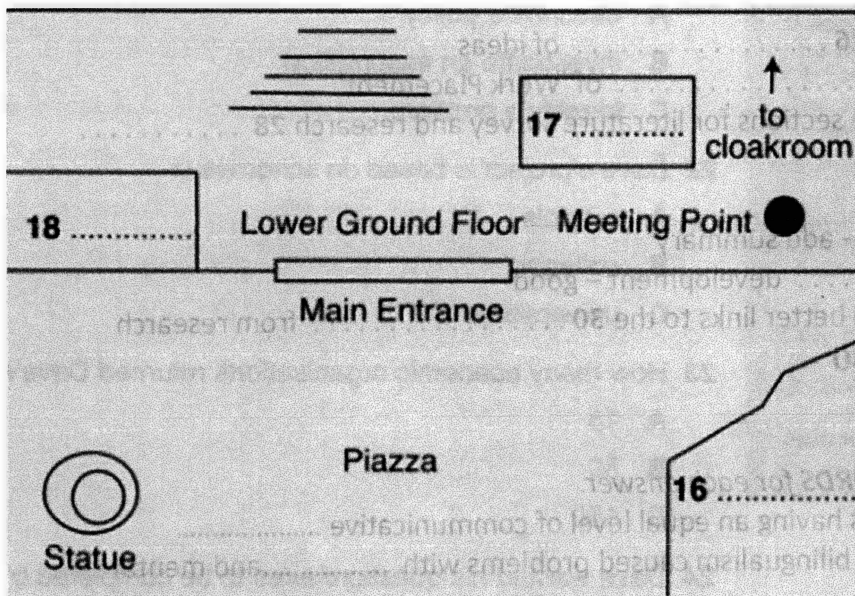
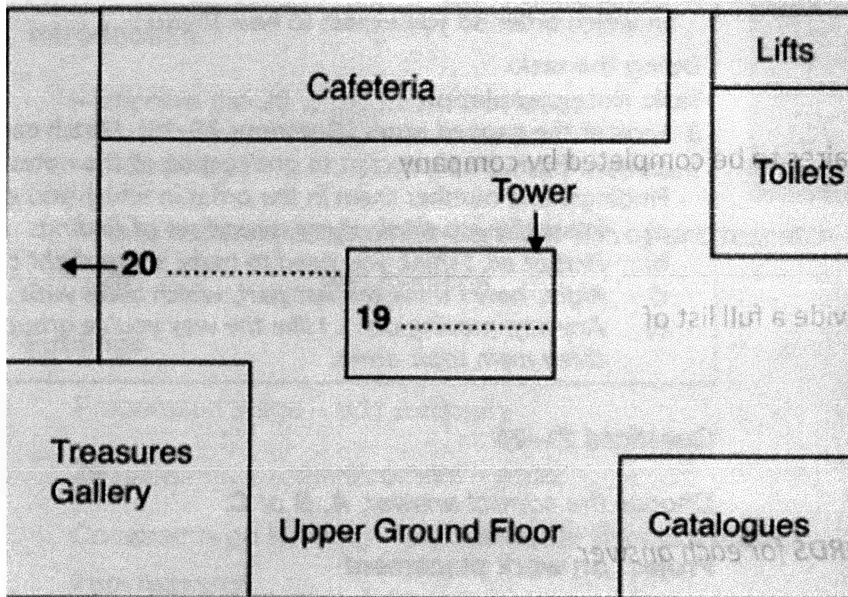

SECTION 3 Questions 21-30

Questions 21-25

Choose the correct answer **A**, **B** or **C**.

Project on work placement

21 The main aim of Dave's project is to

- A** describe a policy.
- B** investigate an assumption.
- C** identify a problem

22 Dave's project is based on schemes in

- A** schools.
- B** colleges.
- C** universities

23 How many academic organisations returned Dave's questionnaire?



- A 15
- B 50
- C 150

24 Dave wanted his questionnaires to be completed by company

- A Human Resources Managers.
- B Line Managers.
- C owners.

25 Dr Green wants Dave to provide a full list of

- A respondents.
- B appendices.
- C companies.

Questions 26-30

Complete the notes below.

Write **NO MORE THAN TWO WORDS** for each answer.

Notes on project

Introduction

- improve the 26 of ideas
- include a 27 of 'Work Placement'
- have separate sections for literature survey and research 28 and methods

Findings

Preparation stage - add summary

29 development – good

Constraints on learning - provide better links to the 30 from research

SECTION 4 Questions 31-40

Questions 31-35

Complete the sentences below.

Write **NO MORE THAN TREE WORDS** for each answer.

31 Bilingualism can be defined as having an equal level of communicative

32 Early research suggested that bilingualism caused problems withand mental development.

33 Early research into bilingualism is now rejected because it did not consider the and background of the children.

34 It is now thought that there is a relationship between bilingualism an cognitive skills in children.

35 Research done by Ellen Bialystok in Canada now suggests that the effects of bilingualism also apply to

Questions 36-40

Choose in the correct letter. A. B or C

36 In Dr Bialystok's experiment, the subjects had to react according to

- A the color of the square on the screen.
- B the location of the square on the screen.
- C the location of the shift key on the keyboard.

37 The experiment demonstrated the "Simon effect" because it involved a conflict between

- A seeing something and reacting times overall.
 - B producing fast and slow reactions.
 - C demonstrating awareness of shape and color.
- 38** The experiment shows that, compared with the monolingual subjects, the bilingual subjects
- A were more intelligent.
 - B had faster reaction times overall.
 - C had more problems with the "Simon effect".
- 39** The result of the experiment indicate that bilingual people may be better at
- A doing different types of tasks as the same time.
 - B thinking about several things at once.
 - C focusing only on what is needed to do a task.
- 40** Dr Bialystok's first and second experiments both suggest that bilingualism may
- A slow down the effects of old age on the brain.
 - B lead to mental confusion among old people.
 - C help old people to stay in better physical condition.

TEST 38

SECTION 1 Questions 1-10

Complete the form below.

*Write **NO MORE THAN THREE WORDS AND/OR A NUMBER** for each answer.*

**Council Youth Scheme
Application for Funding Group Project**

<i>Example</i>	<i>Answer</i>
Name	Ralph Pearson
Contact address	1, Drayton DR6,8AB
Telephone number	01453586098
Name of group	Community Youth Theatre Group
Description of group	amateur theatre group (2 members) Involved in drama 3 and.....
Amount of money requested	4 £
Description of project	to produce a short 5 play for young children
Money needed for	6 for scenery Costumes Cost of 7 8 Sundries
How source of funding will be credited	Acknowledged in the 9 given to audience
Other organizations approached for funding (and outcome)	
National Youth Services – money was 10	

SECTION 2 Questions 11-20

Questions 11-15

Choose the correct answer, A, B, or C.

- 11** Joanne says that visitors to Darwin are often surprised by
- A the number of young people.

- B** the casual atmosphere.
- C** the range of cultures.
- 12** To enjoy cultural activities, the people of Darwin tend to
 - A** travel to southern Australia.
 - B** bring in artists from other areas.
 - C** involve themselves in production.
- 13** The Chinese temple in Darwin
 - A** is no longer used for its original purpose.
 - B** was rebuilt after its destruction in a storm.
 - C** was demolished to make room for new buildings.
- 14** The main problem with travelling by bicycle is
 - A** the climate.
 - B** the traffic.
 - C** the hills.
- 15** What does Joanne say about swimming in the sea?
 - A** It is essential to wear a protective suit.
 - B** Swimming is only safe during the winter.
 - C** You should stay in certain restricted areas

Questions 16-20

What can you find at each of the places below?

Choose your answers from the box and write the correct letter A-H next to Questions 16-20.

- 16** Aquascene
- 17** Smith Street Mall
- 18** Cullen Bay Marina
- 19** Fannie Bay
- 20** Mitchell Street

- A** a flower market
- B** a chance to feed the fish
- C** good nightlife
- D** international arts and crafts
- E** good cheap international food
- F** a trip to catch fish
- G** shops and seafood restaurants
- H** a wide range of different plants

SECTION 3 Questions 21-30

Complete the sentences below.

*Write **NO MORE THAN THREE WORDS** for each answer.*

Effect of weather on mood

- 21** Phil and Stella's goal is to the hypothesis that weather has an effect on a person's mood.
- 22** They expect to find that 'good' weather (weather which is and) has a positive effect on a person's mood.
- 23** Stella defines 'effect on mood' as a in the way a person feels.

Questions 24-27

What information was given by each writer?

Choose your answers from the box and write the letters A-F next to Questions 24-27.

- 24 Vickers
- 25 Whitebourne
- 26 Haverton
- 27 Stanfield

- A the benefits of moving to a warmer environment
- B the type of weather with the worst effect on mood
- C how past events affect attitudes to weather
- D the important effect of stress on mood
- E the important effect of hours of sunshine on mood
- F psychological problems due to having to cope with bad weather

Questions 28-30

Choose **THREE** letters A-H.

Which **THREE** things do Phil and Stella still have to decide on?

- A how to analyse their results
- B their methods of presentation
- C the design of their questionnaire
- D the location of their survey
- E weather variables to be measured
- F the dates of their survey
- G the size of their survey
- H the source of data on weather variables

SECTION 4 Questions 31-40

Questions 31-32

Choose **TWO** letters A-F.

Which two of the following problems are causing concern to educational authorities in the USA?

- A differences between rich and poor students
- B high numbers dropping out of education
- C falling standards of students
- D poor results compare with other nationalities
- E low scores of overseas students
- F differences between rural and urban students

Questions 33-34

Choose **TWO** letters A-F

According to the speaker, what are two advantages of reducing class sizes?

- A more employment for teachers
- B improvement in general health of the population
- C reduction in number of days taken off sick by teachers
- D better use of existing buildings and resources
- E better level of education of workforce
- F availability of better qualified teachers

Questions 35-40

Complete the table below.

Write **NO MORE THAN THREE WORDS AND/OR A NUMBER** for each answer.

USA RESEARCH PROJECTS IN CLASS SIZES

State	School involved	Number of students participating	Key findings	Problems
Tennessee	about 70 schools	in total 35	significant benefit especially for 36 pupils	lack of agreement on implications of data
California	37 schools	1.8 million	very little benefit	shortage of 38 especially in poorer areas no proper method for 39 of project
Wisconsin	14 schools (with pupils from 40 families)		similar results to Tennessee project	

TEST 39

SECTION 1 Questions 1-10

Questions 1-6

Complete the table below.

Write **NO MORE THAN THREE WORDS AND/OR A NUMBER** for each answer.

Budget accommodation in Queenstown, New Zealand

Accommodation	Price (documentary)	Comments
Travellers' Lodge		Example <i>Fully booked</i>
Bingley's	1 US\$	<ul style="list-style-type: none"> • In town centre • Café with regular 2 Nights • Sundeck
Chalet Lodge	US \$ 18.00	<ul style="list-style-type: none"> • Located in a 3 alpine setting



		<ul style="list-style-type: none"> • 10 mins from town centre • 4 are welcome
Globetrotters	US \$18.50	<ul style="list-style-type: none"> • In town centre • 5 Included • Chance to win a 6

Questions 7-10

Who wants to do each of the activities below?

A only Jacinta

B only Lewis

C both Jacinta and Lewis

Write the correct letter, A, B or C, next to the Questions 7 – 10

- 7 bungee jump
- 8 white – water rafting
- 9 jet-boat ride
- 10 trekking on wilderness trial

SECTION 2 Questions 11-20

Questions 11-14

Choose the correct letter, A, B or C.

11 Jack says that in London these days, many people

A see cycling as a foolish activity.

B have no experience of cycling.

C take too many risks when cycling.

12 If people want to cycle to school or work. CitiCyclist helps them by

A giving cycling lessons on the route they take.

B advising them on the safest route to choose.

C teaching them basic skills on quiet roads first.

13 Jack works with some advanced cyclists who want to develop

A international competitive riding skills.

B knowledge of advanced equipment.

C confidence in complex road systems.

14 CitiCyclist supports the view that cyclists should

A have separate sections of the road from motor traffic.

B always wear protective clothing when cycling.

C know how to ride confidently on busy roads.

Questions 15-17

List **THREE** types of organisations for which CitiCyclist provides services.

Write **NO MORE THAN THREE WORDS** for each answer.

15

16

17

Questions 18-20

Complete the notes below.

Write **NO MORE THAN THREE WORDS AND/OR A NUMBER** for each answer.

Website address: citicyclist.co.uk
Phone: 18

Cost (single person): 19 per lesson
Usual length of course: 20 (except complete beginners)

SECTION 3 Questions 21-30

Questions 21-23

Answer the questions below.

Write **NO MORE THAN THREE WORDS** for each answer.

21 What do Sharon and Xiao Li agree was the strongest aspect of their presentation?
.....

22 Which part of their presentation was Xiao Li least happy with?

23 Which section does Sharon feel they should have discussed in more depth?

Questions 24-27

Choose the correct letter A, B or C.

24 Sharon and Xiao Li were surprised when the class said

- A they spoke too quickly.
- B they included too much information.
- C their talk was not well organised.

25 The class gave Sharon and Xiao Li conflicting feedback on their

- A timing
- B use of visuals.
- C use of eye contact.

26 The class thought that the presentation was different from the others because

- A the analysis was more detailed.
- B the data collection was more wide-ranging.
- C the background reading was more extensive

27 Which bar chart represents the marks given by the tutor?

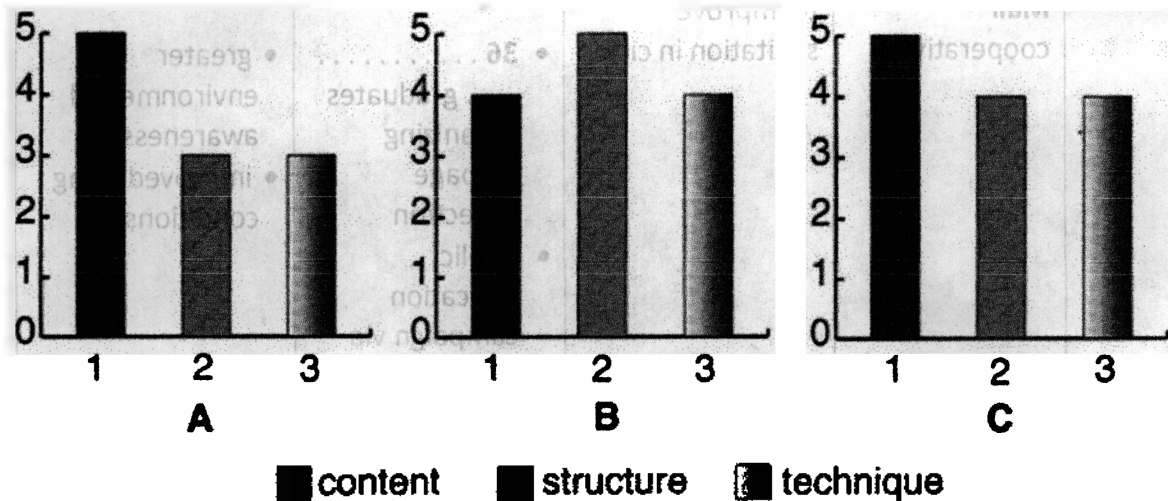

Questions 28-30

Complete the sentences below.

Write **ONE WORD ONLY** for each answer.

28 The tutor says that the of the presentation seemed rather sudden.

29 The tutor praises the students' discussion of the of their results.

30 The tutor suggests that they could extend the review in their report.

SECTION 4 Questions 31-40

Questions 31-33

Complete the notes below.

Write **NO MORE THAN THREE WORDS** for each answer.

The World Health Organization says a healthy city must

- have a **31** and environment.
- meet the **32** of all its inhabitants.
- provide easily accessible health services.
- encourage ordinary people to take part in **33**

Question 34-40

Complete the table below.

Write **NO MORE THAN THREE WORDS** for each answer.

Place/Project	Aim	Method	Achieved
Sri Lanka Community Contracts System	to upgrade squatter settlements	the 34 constructed infrastructure, e.g. drains, plants.	<ul style="list-style-type: none"> • better housing and infrastructure • provided better 35 opportunities

Diyorbek's IELTS



<p>Mali cooperative</p>	<p>to improve sanitation in city</p>	<ul style="list-style-type: none"> • 36 graduates organizing garbage collection • public education campaign via 37 and 	<ul style="list-style-type: none"> • greater environmental awareness • improved living conditions
<p>Egypt (Mokattam) 38</p>	<p>to support disadvantaged women</p>	<p>women provided with the 39 and equipment for sewing and weaving</p>	<ul style="list-style-type: none"> • rise in the 40 and quality of life of young women

TEST 40

SECTION 1 Questions 1-10

Questions 1-7

Choose the correct letter, A, B or C.

Example

The woman says she is interested in

- A part-time employment
- B a permanent job
- C unpaid work

1 The librarian says that training always includes

- A computer skills.
- B basic medical skills.
- C interpersonal skills

2 All library service volunteers have to

- A record their arrival and departure.
- B stay within 'staff only' sections.
- C wear a uniform

3 The woman would be entitled to a contribution towards the cost of

- A transport by minibus.
- B parking at the library.
- C public transport



- 4 One recent library project involved
- A labelling historical objects.
 - B protecting historical photographs.
 - C cataloguing historical documents
- 5 At present, the library is looking for people to
- A record books onto CD
 - B tell stories to children.
 - C read books to the blind.
- 6 The woman says she is interested in a project involving
- A taking library books to people in hospital.
 - B delivering library books to people at home.
 - C driving the disabled to the library.
- 7 The woman agrees to work for
- A two hours per week.
 - B four hours per week.
 - C six hours per week.

Questions 8-10

Choose **THREE** letters A – G.

Which **THREE** of the following must be provided by all volunteers?

- A civil conviction check
- B signed copy of commitment
- C certificates to indicate qualifications
- D emergency contact information
- E date of birth
- F signature of parent or guardian
- G referees

SECTION 2 Questions 11-20

Questions 11-14

Complete the sentences below.

Write **NO MORE THAN TWO WORDS AND/OR A NUMBER** for each answer.

- 11 'Canadian Clean Air Day' will be held on
- 12 Air pollution may be responsible for deaths every year in Canada.
- 13 The sector most responsible for smog-producing pollutants is
- 14 Scientists now know that even of pollutants can be harmful.

Questions 15-20

Complete the sentences below.

Write **NO MORE THAN TWO WORDS AND/OR A NUMBER** for each answer.

Reducing Air Pollution

Individual action

- respond to the 15 '..... Challenge'
- walk, cycle or car-pool to work
- use public transit
- 16

- 17 your domestic equipment

Government action

- emission reduction in the 18 region of US and Canada
- move towards 19 (e.g. less sulphur in gasoline & diesel)
- reduction of pollutants from 20 and power plants

SECTION 3 Questions 21-30

Complete the form below.

*Write **NO MORE THAN THREE WORDS** for each answer.*

Field Trip to Kenya

Area of country: the 21. of Kenya
Accommodation: Marich Pass Field Studies Centre
 in traditional 'bandas' (bring mosquito 22)
 study areas: 23 , lecture room, outdoor areas
Type of environment: both 24 (environment and culture)
Activities: interviews (with interpreters)
 25 (environment and culture)
 morphological mapping
 projects (all connected with 26 issues)
Jack's group did project on: 27 supply and quality issues.
Expeditions: to Sigor (a 28) to study distribution
 to the Wei Wei valley to study agricultural production
 to a 29
Evaluation: logistics - well run
 gave insight into lives of others
 provided input for his 30

SECTION 4 Questions 31-40

Questions 31-34

Complete the flow chart below.

*Write **ONE WORD** for each answer.*



Research methodology

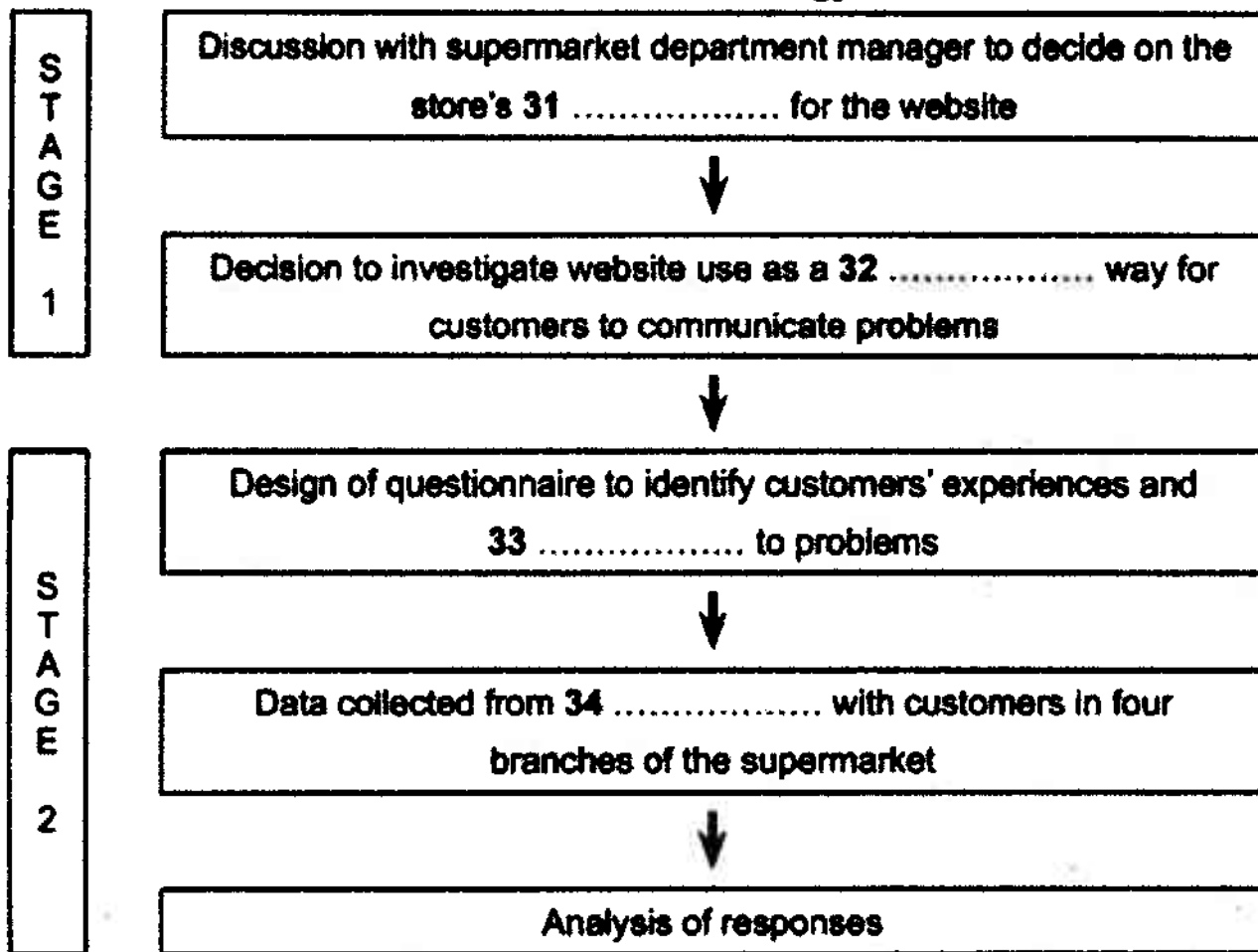

Questions 35–40

35 Which pie chart shows the percentage of respondents who experienced a problem in the supermarket?

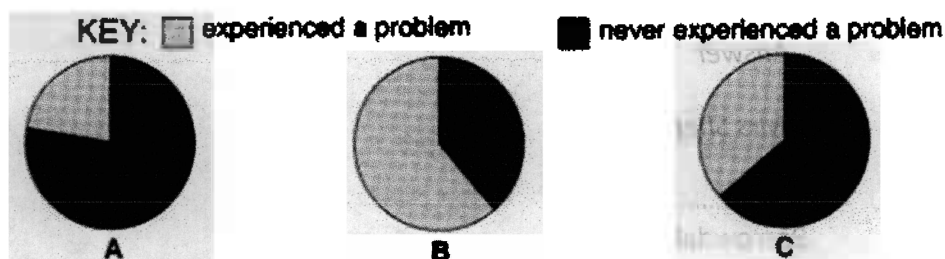

36 Which pie chart shows the reasons why customers failed to report the problem directly to supermarket staff?

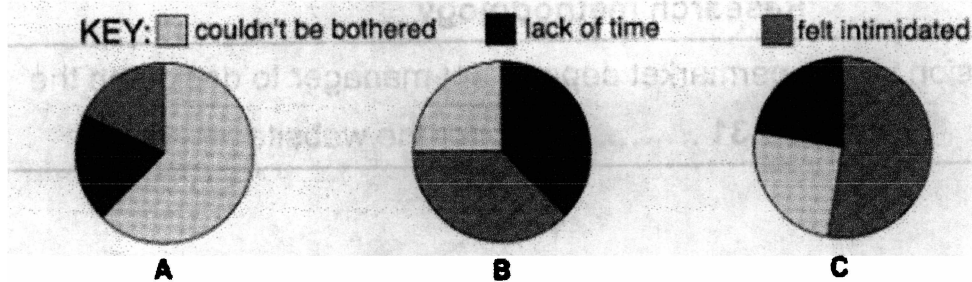

- 37 How might the student's website help the supermarket, according to the manager?
- A it would support the expansion of the company.
 - B it would allow the identification of problem areas..
 - C it would make the company appear more professional.
- 38 The student says one problem in that some customers
- A do not have computer skills
 - B do not have their own computer
 - C do not have access to a computer
- 39 Further observation of website use is necessary because of
- A the small size of the sample
 - B less chance to evaluate the objects.
 - C the unrepresentative nature of the respondents
- 40 One positive result of the website for the supermarket staff could be
- A greater support from management
 - B less chance of unfair complaints
 - C greater cooperation between

TEST 41

SECTION 1 Questions 1-10

Complete the form below.

Write **NO MORE THAN THREE WORDS AND/OR A NUMBER** for each answer.

Report on abandoned vehicle

Example

Answer

Name of caller

Mrs Shefford

Address

41, 1.....

Barrowdale

WH4 5JP

Telephone

2

Vehicle location

in 3 near main road (A69)

Type of vehicle

4

Make

Catala

Model

5

Present colour of vehicle

6

Vehicle number

S 322 GEC

General condition

poor – one 7 , cracked windscreen

SECTION 3 Questions 21-30

Questions 21-23

Choose the best answer, A, B or C

21 What is the main thing Julia feels she has gained from her experience in retail?

- A better understanding of customer attitudes
- B improved ability to predict fashion trends
- C more skill in setting priorities in her work

22 Why is Julia interested in doing the postgraduate course?

- A It will enable her to develop new types of technology.
- B It will allow her to specialise in a design area of her choice.
- C It will provide managerial training focusing on her needs.

23 What would Julia like to do after she has completed the postgraduate course?

- A work overseas
- B start her own business
- C stay in an academic environment

Questions 24-27

What does each university facility have?

Choose your answers from the box and write the correct letter A-G next to Questions 24-27.

- 24** Library
- 25** Computer Centre
- 26** Photomedia
- 27** Time Based Media

- A laboratories
- B rooms for individual study
- C inter-disciplinary focus
- D introductory course
- E purpose-built premises
- F cafeteria
- G emphasis on creative use

Questions 28-30

Complete the summary below.

Write **NO MORE THAN TWO WORDS** for each answer.

MA in Fashion Design: Assessment

Assessment includes three **28** which take place at the end of the stages of the degree. Final assessment is based on a project, and includes the student's **29** in the form of a written report, and the **30** to which representatives of fashion companies are invited.

SECTION 4 Questions 31-40

Questions 31-40

Complete the notes below.

Write **NO MORE THAN THREE WORDS** for each answer.

Laughter

The nature of laughter

- Laughter is a **31** process-involves movement and sound.
- It is controlled by our **32**

Reasons for laughter

- Only 10% of laughter is caused by jokes / funny stories.
- May have begun as sign of 33 after a dangerous situation.
- Nowadays, mat help to develop 34 within a group.
- Connected to 35 (e.g. use of humor by politicians or bosses).
- May be related to male / female differences (e.g. women laugh more at male speakers).
- May be used in a 36 way to keep someone out of a group.

Benefits of laughter

- Safe method for the 37 of emotions such as anger and sadness.
- Provides good aerobic exercise.
- Leads to drop in levels of stress-related 38
- Improves the 39
- Can stop 40 and improve sleep.

TEST 42

SECTION 1 Questions 1-10

Complete the form below.

Write **NO MORE THAN TWO WORDS OR A NUMBER** for each answer.

Health club customer research

Example	Answer
Name:	Selina Thompson
Occupation:	1
Age group:	2
Type of membership:	3
Length of membership:	4 years
Why joined:	Recommended by a 5
Visited to club per month:	Eight (on an average)
Facility used most:	6
Facility not used (if any):	Tennis courts (because reluctant to 7
Suggestions for improvements:	Have more 8
	Install 9 in the gym.
	Open 10 later at weekends



SECTION 2 Questions 11-20

Questions 11-16

Complete the flow chart below.

Choose *SIX* answers from the box and write the correct letter, A-G, next to questions 11-16.

- A air B ash C earth D grass
E sticks F stones G water

Making a steam pit

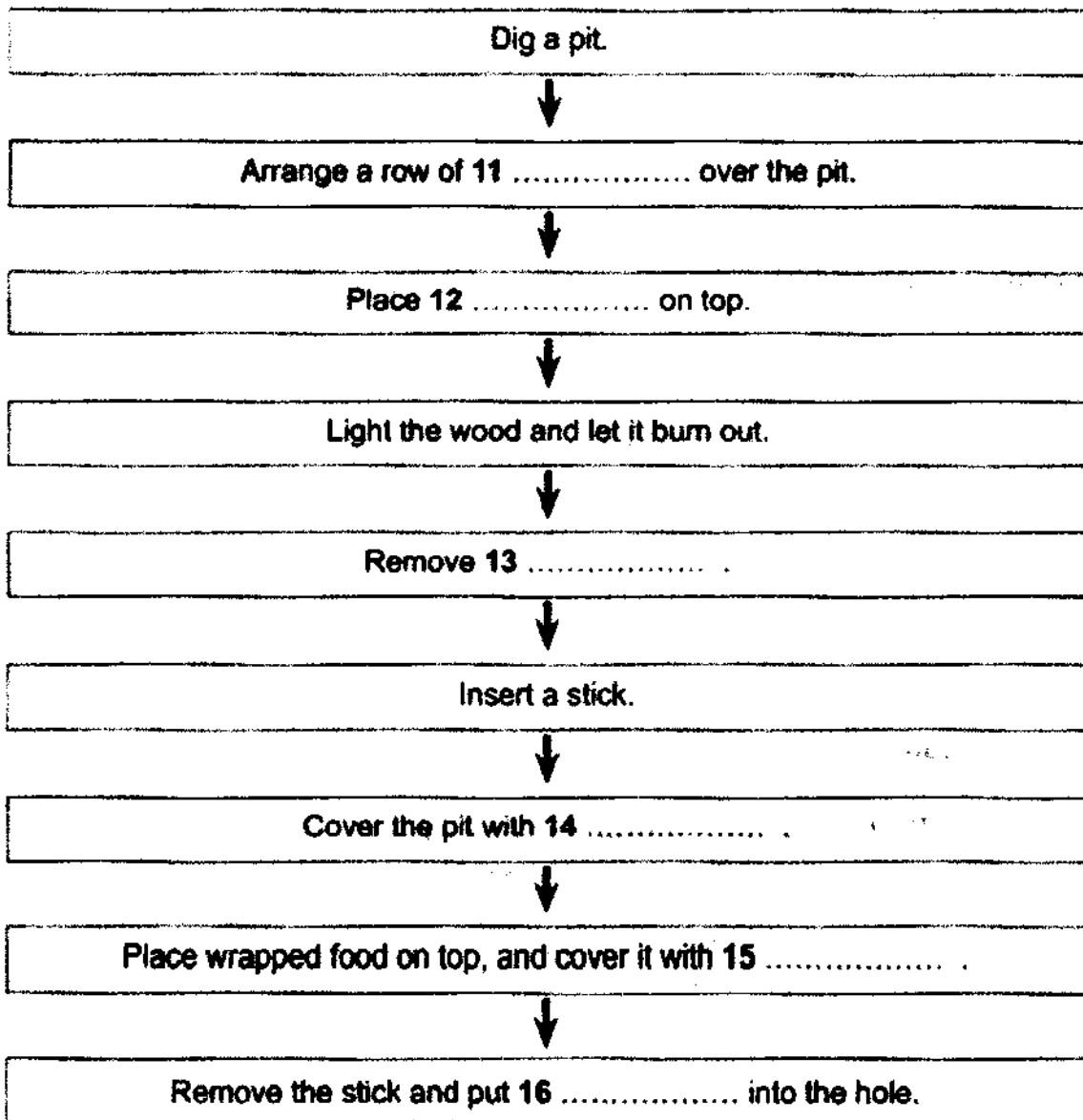

Questions 17-18

Choose *TWO* letters, A-E.

Which **TWO** characteristics apply to the bamboo oven?

- A It's suitable for windy weather.
- B The fire is lit below the bottom end of the bamboo.
- C The bamboo is cut into equal lengths.

- D The oven hangs from a stick.
- E It cooks food by steaming it.

Questions 19-20

Choose **TWO** letters, A-E.

Which **TWO** pieces of advice does the speaker give about eating wild fungi?

- A Cooking doesn't make poisonous fungi edible.
- B Edible wild fungi can be eaten without cooking.
- C Wild fungi are highly nutritious.
- D Some edible fungi look very similar to poisonous varieties.
- E Fungi which cannot be identified should only be eaten in small quantities

SECTION 3 Questions 21-30

Questions 21-25

Research project on attitudes towards study

- 21** Phoebe's main reason for choosing her topic was that
- A her classmates had been very interested in it.
 - B it would help prepare her for her first teaching post.
 - C she had been inspired by a particular book.
- 22** Phoebe's main research question related to
- A the effect of teacher discipline.
 - B the variety of learning activities.
 - C levels of pupil confidence.
- 23** Phoebe was most surprised by her finding that
- A gender did not influence behaviour significantly.
 - B girls were more negative about school than boys.
 - C boys were more talkative than girls in class.
- 24** Regarding teaching, Phoebe says she has learned that
- A teachers should be flexible in their lesson planning.
 - B brighter children learn from supporting weaker ones.
 - C children vary from each other in unpredictable ways.
- 25** Tony is particularly impressed by Phoebe's ability to
- A recognise the limitations of such small-scale research.
 - B reflect on her own research experience in an interesting way.
 - C design her research in such a way as to minimise difficulties

Questions 26-30

What did Phoebe find difficult about the different research techniques she used?

Choose **FIVE** answers from the box and write the correct letter A-G, next to questions 26-30.

Research techniques

- 26** Observing lessons
- 27** Interviewing teachers
- 28** Interviewing pupils
- 29** Using questionnaires
- 30** Taking photographs

Difficulties

- A Obtaining permission
- B Deciding on a suitable focus
- C Concentrating while gathering data
- D Working collaboratively
- E Processing data she had gathered
- F Finding a suitable time to conduct the research
- G Getting hold of suitable equipment

SECTION 2 Questions 11-20

Questions 11-15

Choose the correct answer, A, B or C.

Tamerton Centre

11 The Tamerton Centre was set up in order to encourage people

- A** to enjoy being in the countryside.
- B** to help conserve the countryside.
- C** to learn more about the countryside.

12 Last year's group said that the course

- A** built their self esteem.
- B** taught them lots of new skills.
- C** made them fitter and stronger.

13 For the speaker, what's the most special feature of the course?

- A** You can choose which activities you do.
- B** There's such a wide variety of activities.
- C** You can become an expert in new activities.

14 The speaker advises people to bring

- A** their own board games.
- B** extra table tennis equipment.
- C** a selection of films on DVD.

15 Bed-time is strictly enforced because

- A** it's a way to reduce bad behaviour.
- B** tiredness can lead to accidents.
- C** it makes it easy to check everyone's in.

Questions 16-20

What rules apply to taking different objects to the Centre?

Match each object with the correct rule, A-C.

Write the correct letter, A-C.

Objects

- 16** Electrical equipment
- 17** Mobile phone
- 18** Sun cream
- 19** Aerosol deodorant
- 20** Towel

Rules
A You MUST take this
B You CAN take this, if you wish
C You must NOT take this

SECTION 3 Questions 21-30

Questions 21-25

Label the diagram below.

Write the correct letter, A-G, next to questions 21-25 below.

- 21** Waste container
- 22** Slurry
- 23** Water inlet
- 24** Gas
- 25** Overflow tank



(Year 6 Lesson)

Biogas Plant

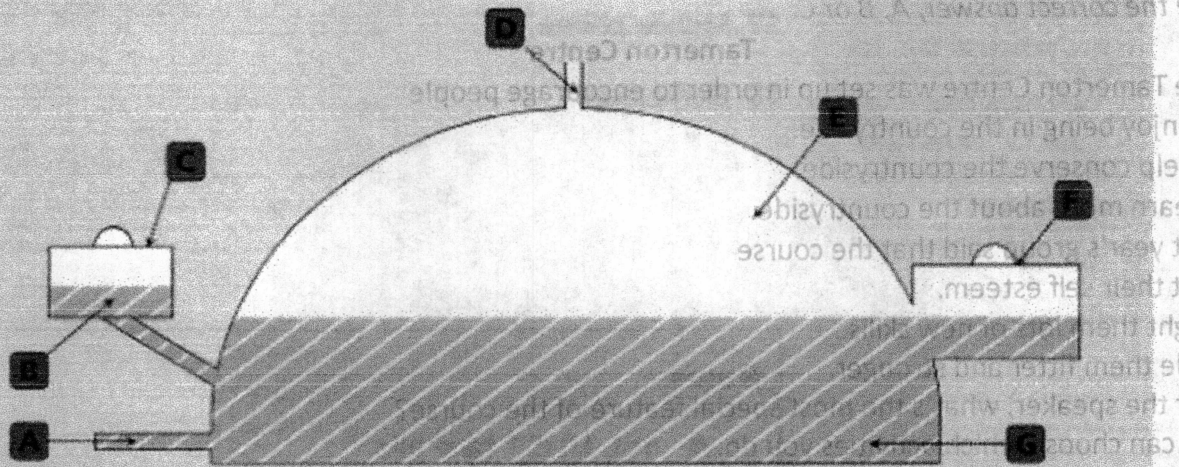

Questions 26-30

Complete the flow chart below.

Choose FIVE answers from the box and write the correct letter, A-G, next to questions 26-30.

- A Identify sequence.
- B Ask questions.
- C Copy.
- D Demonstrate meaning.
- E Distribute worksheet.
- F Draw pictures.
- G Present sentences.

**LESSON OUTLINE YEAR THREE
TOPIC: ENERGY**

ACTIVITIES

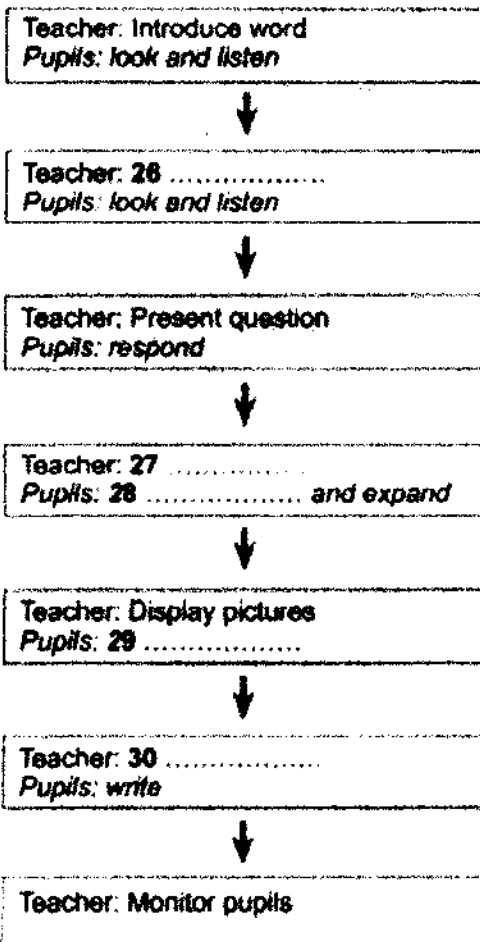

SECTION 4 Questions 31-40

Complete the notes below.

Write **NO MORE THAN TWO WORDS** for each answer.

Creating artificial gills

Background

- Taking in oxygen: mammals – lunge; fish-gills.
- Long-held dreams – humans swimming underwater without oxygen tanks.
- Oxygen tanks considered too 31 and large.
- Attempts to extract oxygen directly from water.
- 1960s – prediction that humans would have gills added 32
-
- Ideas for artificial gills were inspired by research on.

- fish gills
- fish swim bladders
- animals without gills – especially bubbles used by 33

Building a simple artificial gill

- Make a watertight box of material which lets 34 pass through.
- Full with air submerge in water.
- Important that the diver and the water keep 35
- The gill has to have a large 36
- Designers often use a network of small 37 on their gill.
- Main limitation – problems caused by increased 38 in deeper water.

Other applications

- Supplying oxygen for use on 39
- Powering 40 cells for driving machinery underwater.

TEST 44

SECTION 1 Questions 1-10

Complete the notes below.

Write **NO MORE THAN ONE WORD OR A NUMBER** for each answer

Car for sale (Mini)

Example

Age of car: just under 13 years old

Colour: 1

Mileage: 2

Previous owner was a 3

Current owner has used car mainly for 4

Price: may accept offers from 5 £.....

(Note: 6 not due for 5 months)

Condition: good (recently serviced)

Will need a new 7..... soon

Minor problem with a 8

Viewing

Agreed to view the car on 9 a.m.

Address:

238, 10 Road



SECTION 2 Questions 11-20

Questions 11-14

Choose the correct letter, A, B or C.

- 11** The Treloar Valley passenger ferry
A usually starts services in April.
B departs at the same time each day.
C is the main means of transport for local villagers.
- 12** What does the speaker say about the river cruise?
A It can be combined with a train journey.
B It's unsuitable for people who have walking difficulties.
C The return journey takes up to four hours.
- 13** What information is given about train services in the area?
A Trains run non-stop between Calton and Plymouth.
B One section of the rail track is raised.
C Bookings can be made by telephone or the Internet.
- 14** The 'Rover' bus ticket
A can be used for up to five journeys a day.
B is valid for weekend travel only.
C has recently gone down in price.

Questions 15-20

Label the map below.

Write the correct letter, A-H, next to questions 15-20.

- 15** Bus stop
- 16** Car park
- 17** Museum
- 18** Mill
- 19** Potter's studio
- 20** Café

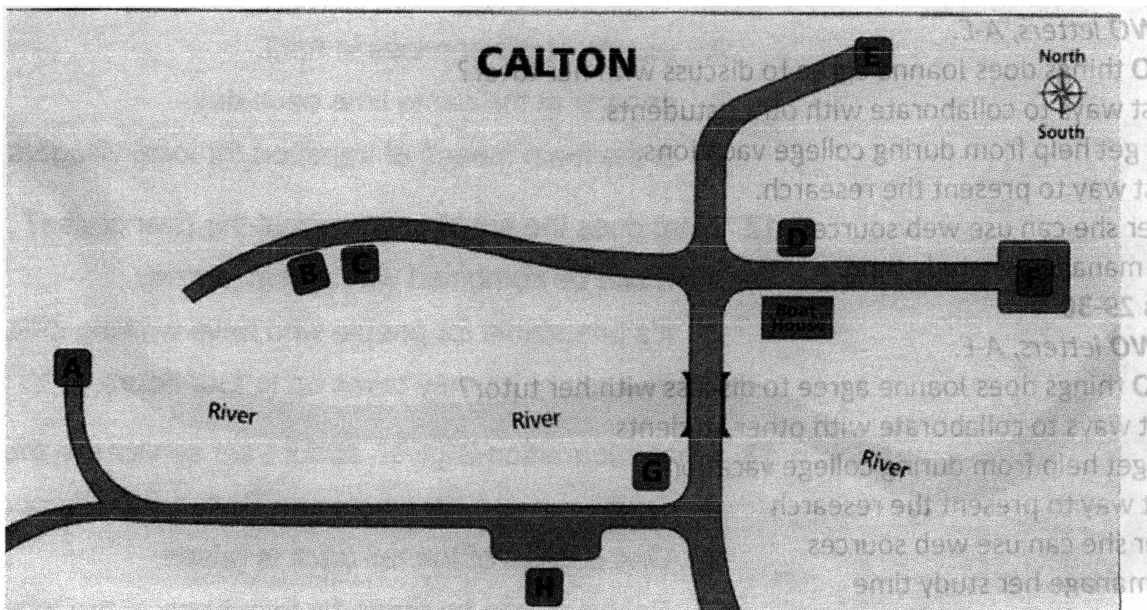

SECTION 3 **Questions 21-30**

Questions 21-24

Choose the correct letter, A, B or C.

Advice on writing a dissertation

21 What does Howard say about the experience of writing his dissertation?

- A It was difficult in unexpected ways.
- B It was more enjoyable than he'd anticipated.
- C It helped him understand previous course work.

22 What is Joanne most worried about?

- A Finding enough material.
- B Missing deadlines.
- C Writing too much.

23 What does Howard say was his main worry a year previously?

- A Forgetting what he'd read about.
- B Not understanding what he'd read.
- C Taking such a long time to read each book

24 What motivated Howard to start writing his dissertation?

- A Talking to his tutor about his problems
- B Seeing an inspirational TV show
- C Reading a controversial journal article

Questions 25-26

Choose TWO letters, A-E.

What **TWO** things does Howard advise Joanne to do in the first month of tutorials?

- A See her tutor every week.
- B Review all the module booklists.
- C Buy all the key books.
- D Write full references for everything she reads.
- E Write a draft of the first chapter

Questions 27-28

Choose TWO letters, A-E.

What **TWO** things does Joanne agree to discuss with her tutor?

- A The best ways to collaborate with other students.
- B Who to get help from during college vacations.
- C The best way to present the research.
- D Whether she can use web sources.
- E How to manage her study time.

Questions 29-30

Choose TWO letters, A-E.

What **TWO** things does Joanne agree to discuss with her tutor?

- A The best ways to collaborate with other students
- B Who to get help from during college vacations
- C The best way to present the research
- D Whether she can use web sources
- E How to manage her study time

SECTION 4 Questions 31-40

Complete the flow chart below.

Write **NO MORE THAN TWO WORDS** for each answer.

Expertise in creative writing

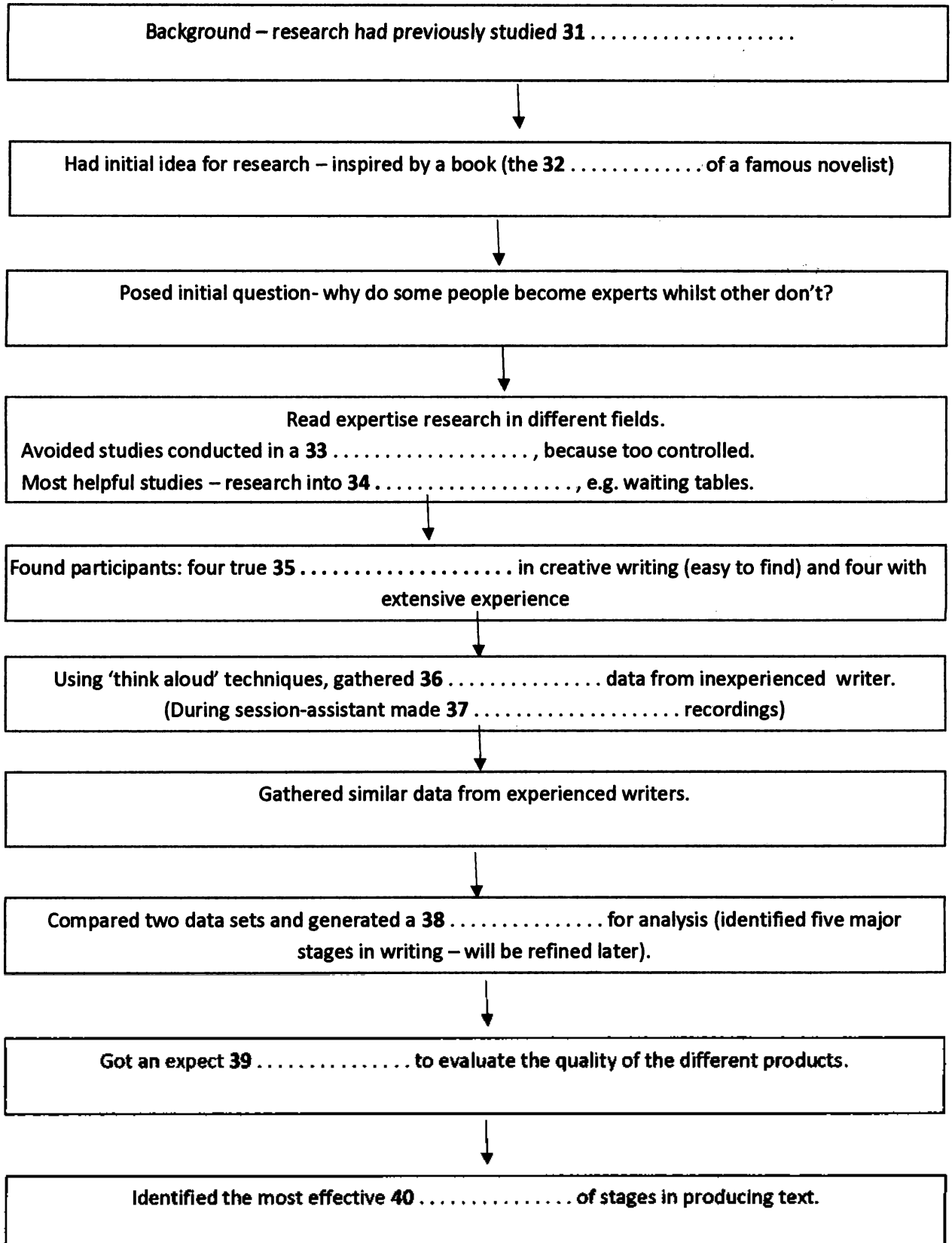



TEST 45

SECTION 1 Questions 1-10

Complete the notes below.

Write **ONE WORD AND/OR A NUMBER** for each answer.

Things to do before we go

Example

Collect the currency

Cancel appointment with the 1(Monday)

Begin taking the 2(Tuesday)

Buy

- 3,
- a small bag
- a spare 4
- an electrical 5

Book a 6

Instructions for Laura's mum

Feed the cat

Vet's details :

Name: Colin 7

Tel: 8

Address: Fore Street (opposite the 9

Water the plants

Meet the heating engineer on 10

SECTION 2 Questions 11-20

Questions 11-16

Choose the correct answer A, B or C.

Adbourne Film Festival

11 Why was the Film Festival started?

- A To encourage local people to make films.
- B To bring more tourists to the town.
- C To use money released from another project.

12 What is the price range for tickets?

- A £1.00-£2.50
- B 50p - £2.00
- C £1.50-£2.50

13 As well as online, tickets for the films can be obtained

- A from the local library.
- B from several different shops.
- C from the two festival cinemas.

14 Last year's winning film was about

- A farms of the future.
- B schools and the environment.
- C green transport options.

15 This year the competition prize is

- A a stay in a hotel.
- B film-making equipment.

C a sum of money.

16 The deadline for entering a film in the competition is the end of

A May.

B June.

C July.

Questions 17-18

Choose **TWO** letters, A-E.

What **TWO** main criteria are used to judge the film competition?

A Ability to persuade.

B Quality of the story.

C Memorable characters.

D Quality of photography.

E Originality.

Questions 19-20

Choose **TWO** letters, A-E.

What **TWO** changes will be made to the competition next year?

A A new way of judging.

B A different length of film.

C An additional age category.

D Different performance times.

E New locations for performances.

SECTION 3 Questions 21-30

Questions 21-24

Choose the correct letter, A, B or C.

Research on web-based crosswords

21 Leela and Jake chose this article because

A it was on a topic familiar to most students.

B it covered both IT and education issues.

C it dealt with a very straightforward concept.

22 How did Leela and Jake persuade students to take part in their research?

A They convinced them they would enjoy the experience.

B They said it would help them do a particular test.

C They offered to help them with their own research later on.

23 Leela and Jake changed the design of the original questionnaire because

A it was too short for their purposes.

B it asked misleading questions

C it contained out-of-date points.

24 Leela was surprised by the fact that

A it is normal for questionnaire returns to be low.

B so many students sent back their questionnaires

C the questionnaire responses were of such high quality.

Questions 25-30

Questions 25-26

Choose **TWO** letters, A-E.

What **TWO** things did respondents say they liked most about doing the crossword?

- A It helped them spell complex technical terms.
- B It was an enjoyable experience.
- C It helped them concentrate effectively.
- D It increased their general motivation to study.
- E It showed what they still needed to study.

Questions 27-28

Choose **TWO** letters, A-E.

In which **TWO** areas did these research findings differ from those of the original study?

- A Students' interest in doing similar exercises.
- B How much students liked doing the crossword.
- C Time taken to do the crossword.
- D Gender differences in appreciation.
- E Opinions about using crosswords for formal assessment.

Questions 29-30

Choose **TWO** letters, A-E.

What **TWO** skills did Leela and Jake agree they had learned from the project?

- A How to manage their time effectively.
- B How to process numerical data.
- C How to design research tools.
- D How to reference other people's work.
- E How to collaborate in research.

SECTION 4 Questions 31-40

Complete the form below

Write **NO MORE THAN TWO WORDS** for each answer.

Job satisfaction study

- 31 Workers involved in the study were employed at a
- 32 Despite some apparent differences between groups of workers, the survey results were statistically
- 33 The speaker analyzed the study'sto identify any problems with it.
- 34 The various sub-groups were in size.
- 35 Workers in the part-time group were mainly
- 36 The of workers who agreed to take part in the study was disappointing.
- 37 Researchers were unable to the circumstances in which workers filled out the questionnaire.
- 38 In future, the overall size of the should be increased.
- 39 In the future studies, workers should be prevented from having discussions with
- 40 Workers should be reassured that their responses to questions are

TEST 46

SECTION 1 Questions 1-10

Questions 1-2

Complete the notes below.

Write **NO MORE THAN ONE WORD** for each answer.

Advice on plumbers and decorators

Example

Make sure the company is: *local*

Don't call a plumber during the 1

Look at trade website: 2 www.com

Questions 3-10

Complete the table below.

Write **NO MORE THAN ONE WORD** for each answer.

Name	Positive points	Negative points
Peake's Plumbing	<ul style="list-style-type: none"> • Pleasant and friendly • Give 3 Information • Good quality work 	<ul style="list-style-type: none"> • Always 4
John Damerol Plumbing services	<ul style="list-style-type: none"> • 5 than other companies • Reliable 	<ul style="list-style-type: none"> • Not very polite • Tends to be 6
Simonson Plasterers	<ul style="list-style-type: none"> • Able to do lots of different 7 	<ul style="list-style-type: none"> • More 8 than other companies
H.L. Plastering	<ul style="list-style-type: none"> • Reliable • Also able to do 9 	<ul style="list-style-type: none"> • Prefers not to use long 10

SECTION 2 Questions 11-20

Questions 11-15

Choose the correct answer, A, B or C.

Museum work placement

11 On Monday, what will be the students' working day?

A 9.00 a.m. - 5.00 p.m.

B 8.45 a.m. - 5.00 p.m.

C 9.00 a.m. - 4.45 p.m.

12 While working in the museum, students are encouraged to wear

A formal clothing such as a suit.

B a cap with the museum logo.

C their own casual clothes.

13 If students are ill or going to be late, they must inform



- A the museum receptionist.
 - B their museum supervisor.
 - C their school placement tutor.
- 14 The most popular task whilst on work placement is usually
- A making presentations in local primary schools.
 - B talking to elderly people in care homes.
 - C conducting workshops in the museum.
- 15 The best form of preparation before starting their work placement is to read
- A the history of the museum on the website.
 - B the museum regulations and safety guidance.
 - C notes made by previous work placement students.

Questions 16-20

Label the plan below.

Write the correct letter, A-I, next to questions 16-20

Where in the museum are the following places?

- 16 Sign-in office
- 17 Gallery
- 18 Key box
- 19 Kitchen area
- 20 Staff noticeboard

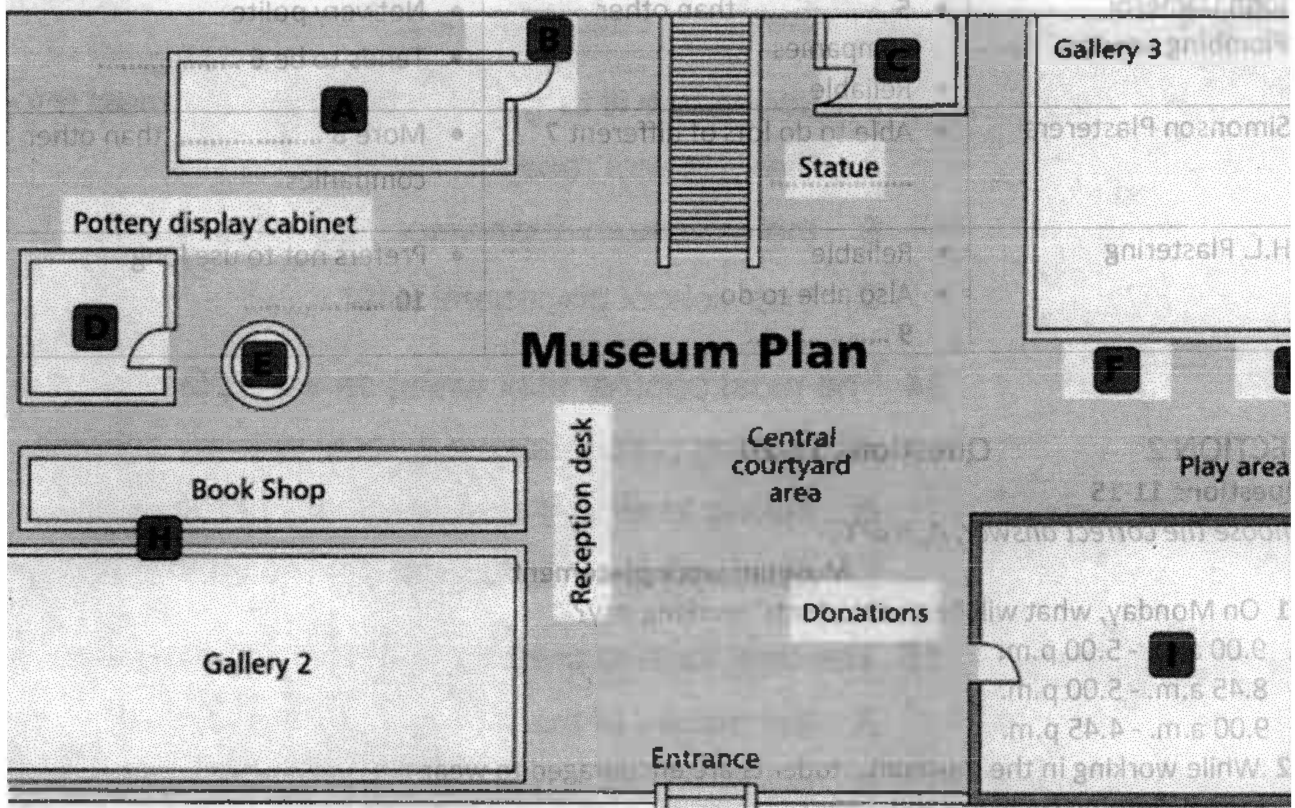

SECTION 3 Questions 21-30

Questions 21-26

What is the tutor's opinion of the following company projects?

Choose **FIVE** answers from the box, and write the correct letter, A-H, next to questions 21-26.

	Tutor's opinion
A	It would be very rewarding for the student.
B	It is too ambitious.
C	It would be difficult to evaluate.
D	It wouldn't be sufficiently challenging.
E	It would involve extra costs.
F	It is beyond the student's current ability.
G	It is already being done by another student.
H	It would probably have the greatest impact on the company.

Company projects

- 21** Customer database
- 22** Online sales catalogue
- 23** Payroll
- 24** Stock inventory
- 25** Internal security
- 26** Customer services

Questions 27-28

Choose **TWO** letters, A-E.

Which **TWO** problems do Sam and the tutor identify concerning group assignments?

- A** Personal relationships.
- B** Cultural differences
- C** Division of labour.
- D** Group leadership.
- E** Group size.

Questions 29-30

Choose **TWO** letters, A-E.

Which **TWO** problems does Sam identify concerning the lecturers?

- A** Punctuality.
- B** Organisation.
- C** Accessibility.
- D** Helpfulness.
- E** Teaching materials.

SECTION 4 Questions 31-40

Complete the notes below.

Write **ONE WORD ONLY** for each answer.

The Tawny Owl

Most **31** owl species in UK

Strongly nocturnal

Habitat

Mainly lives in **32**, but can also be seen urban areas, e.g. parks



Adaptations:

- Short wings and **33** , for navigation
- Brown and **34** feathers, for camouflage
- Large eyes (more effective than those of **35**), for good night vision
- Very good spatial **36** , for predicting where prey might be found
- Excellent **37** for locating prey from a perch

Diet

Main food is small mammals.
Owls in urban areas eat more **38**

Survival

Two thirds of young owls die within a **39**
Owls don't disperse over long distances.
Owl seems to like flying over long areas of **40**

TEST 47

SECTION 1 Questions 1-10

Complete the form below.

Write **ONE WORD AND/OR A NUMBER** for each answer.

HOLIDAY RENTALS Dates: Example 10 th -22 th July				
Name of Property	Location	Features	Disadvantage(s)	Booking details
1	• rural • surrounded by 2	• apartment • two bedrooms • open plan	distance from 3	www. 4 com
Kingfisher	• rural • next to the 5 • nice views	• house • three bedrooms • 6 room • living room • kitchen	expensive?	Phone the owner (01752669218)
Sunnybanks	in a village next to the 7	• house • has private 8	no 9	Contact the 10



SECTION 2 **Questions 11-20**

Questions 11-14

Choose the correct letter, A, B or C.

- 11** According to the speaker, why is it a good time for D-I-Y painting?
- A** There are better products available now.
 - B** Materials cost less than they used to.
 - C** People have more free time than before.
- 12** What happened in 2009 in the UK?
- A** A record volume of paint was sold.
 - B** A large amount of paint was wasted.
 - C** There was a major project to repaint public buildings.
- 13** What does the speaker say about paint quantity?
- A** It's not necessary to have exact room measurements.
 - B** It's better to overestimate than to underestimate.
 - C** An automatic calculator can be downloaded from the Internet.
- 14** What does Community RePaint do?
- A** It paints people's houses without payment.
 - B** It collects unwanted paint and gives it away.
 - C** It sells unused paint and donates the money to charity.

Questions 15-16

Choose TWO letters, A-E.

What **TWO** pieces of advice does the speaker give about paint?

- A** Don't buy expensive paint.
- B** Test the colour before buying a lot.
- C** Choose a light colour.
- D** Use water-based paint.
- E** Buy enough paint for more than one application.

Questions 17-18

Choose TWO letters, A-E.

What **TWO** pieces of advice does the speaker give about preparation?

- A** Replace any loose plaster.
- B** Don't spend too long preparing surfaces.
- C** Use decorators' soap to remove grease from walls.
- D** Wash dirty walls with warm water.
- E** Paint over cracks and small holes.

Questions 19-20

Choose TWO letters, A-E.

What **TWO** pieces of advice does the speaker give about painting?

- A** Put a heater in the room.
- B** Wash brushes in cold water.
- C** Use a roller with a short pile.
- D** Apply paint directly from the tin.
- E** Open doors and windows.



SECTION 3 Questions 1-10

Questions 21-26

Choose the correct letter, **A**, **B** or **C**.

- 21** Why is Matthew considering a student work placement?
A He was informed about an interesting vacancy.
B He needs some extra income.
C He wants to try out a career option.
- 22** Which part of the application process did Linda find most interesting?
A The psychometric test.
B The group activity.
C The individual task.
- 23** During her work placement, Linda helped find ways to
A speed up car assembly.
B process waste materials.
C calculate the cost of design faults
- 24** Why did Linda find her work placement tiring?
A She wasn't used to full-time work.
B The working hours were very long.
C She felt she had to prove her worth.
- 25** What did Linda's employers give her formal feedback on?
A engineering ability
B organisational skills
C The opportunity to use new software.
- 26** What was the main benefit of Linda's work placement?
A improved academic skills
B an offer of work
C the opportunity to use new software

Questions 27-30

What does Linda think about the books on Matthew's reading list?

Choose **FOUR** answers from the box and write the correct letter, **A-F**, next to questions 27-30.

Books

- 27** The Science of Materials
- 28** Materials Engineering
- 29** Engineering Basics
- 30** Evolution of Materials

Opinions	
A	helpful illustrations
B	easy to understand
C	up-to-date
D	comprehensive
E	specialised
F	useful case studies

SECTION 4 Questions 31-40

Complete the notes below.

Write **NO MORE THAN TWO WORDS** for each answer.

Researching the origin of medieval manuscripts

Background

- Medieval manuscripts - handwritten books produced between the fifth and fifteenth centuries
- Origin of many manuscripts unknown until 2009; scientists started using DNA testing.

Animal hides – two types

Parchment

Sheep skin: white in color and **31**

Greasy – writing can't be erased so often used for **32**

Vellum

Calf skin: most popular for prestigious work because you can get **33** lettering.

Preparation of hides

- Treated in barrels of lime – where this was not available, skins were **34**
.. (removed hair more flexible)
- Stretched tight on a frame
- Scraped to create same **35**
- Vellum was **36** – for correct color

Genetic testing – finding origins

Previously – analyzed hand writing and **37** used by the writer

Now – using genetic data from 'known manuscripts' to create a **38** '.....'

Uses of a new data

Gives information on individual books

Shows the **39** of the book industry

Helps define **40** in medieval period

TEST 48

SECTION 1 Questions 1-10

Complete the notes below.

Write **NO MORE THAN TWO WORDS OR A NUMBER** for each answer.

Notes for holiday

Travel information

Example

Will email the *flight number*

- must find out which **1** arriving at
- best taxi company **2**
- Note: Simon lives in the **3** of the city
- Simon's cell phone number: **4**

What to pack

(to wear)

- casual clothes
- one smart dress – to wear at a **5**
- a good **6**
- tough **7**

(to read)

- try to find book named **8** '.....' By Rex Campbell

(for presents)

- for Janice: **9**
- for Alec: **10** (with racing pictures)

SECTION 2 Questions 11-20

Questions 11-16

Choose the correct answer, A, B or C.

Camber's Theme Park

11 According to the speaker, in what way is Camber's different from other theme parks?

- A** It's suitable for different age groups.
- B** It offers lots to do in wet weather.
- C** It has a focus on education.

12 The Park first opened in

- A** 1980.
- B** 1997
- C** 2004.

13 What's included in the entrance fee?

- A** most rides and parking
- B** all rides and some exhibits
- C** parking and all rides

14 Becoming a member of the Adventurers Club means

- A** you can avoid queuing so much.
- B** you can enter the Park free for a year.
- C** you can visit certain zones closed to other people.

15 The Future Farm zone encourages visitors to

- A** buy animals as pets.
- B** learn about the care of animals.
- C** get close to the animals.

16 When is hot food available in the park?

- A** 10.00 a.m. - 5.30 p.m.

B 11.00 a.m. - 5.00 p.m.

C 10.30 a.m. - 5.00 p.m.

Questions 17-20

What special conditions apply to the following rides?

Choose **FOUR** answers from the box and write the correct letter, A-F, next to the questions 17-20.

Rides

17 River Adventure

18 Jungle Jim Rollercoaster

19 Swoop Slide

20 Zip Go-Carts

Special conditions for visitors

- A** Must be over a certain age
- B** Must use special safety equipment
- C** Must avoid it if they have health problems
- D** Must wear a particular type of clothing
- E** Must be over a certain height
- F** Must be accompanied by an adult if under

SECTION 3 Questions 21-30

Questions 21-22

Choose **TWO** letters, A-E.

What **TWO** things do Brad and Helen agree to say about listening in groups?

- A** Listening skills are often overlooked in business training.
- B** Learning to listen well is a skill that's easy for most people to learn.
- C** It's sometimes acceptable to argue against speakers.
- D** Body language is very important when listening.
- E** Listeners should avoid interrupting speakers.

Questions 23-24

Choose **TWO** letters, A-E.

What **TWO** things does the article say about goal-setting?

- A** Meetings should start with a clear statement of goals.
- B** It's important for each individual's goals to be explained.
- C** Everybody in the group should have the same goals.
- D** Goals should be a mix of the realistic and the ideal.
- E** Goals must always to be achievable within a set time.

Questions 25-26

Choose **TWO** letters, A-E.

What **TWO** things do Brad and Helen agree are weak points in the article's section on conflict resolution?

- A** It doesn't explore the topic in enough detail.
- B** It only discusses conservative views.
- C** It says nothing about the potential value of conflict.
- D** It talks too much about 'winners and losers'.
- E** It doesn't provide definitions of key terms.

Questions 27-30

What actions do Brad and Helen agree to do regarding the following preparation tasks?

Choose **FOUR** answers from the box and write the correct letter, A-F, next to the number.

Preparation tasks

- 27 Preparing the powerpoint
- 28 Using direct quotations
- 29 Creating a handout
- 30 Drawing up a bibliography

Action	
A	Contact the tutor for clarification.
B	Check the assignment specifications.
C	Leave it until the last task.
D	Ask a course-mate to help.
E	Find information on the Internet.
F	Look through course handbooks.

SECTION 4 Questions 31-40

Complete the form below.

*Write **ONE WORD ONLY** for each answer.*

Engineering for sustainable development

The Greenhouse Project (Himalayan Mountain Region)

Problems

- Short growing season because of high altitude and low **31**
- Fresh vegetables imported by lorry or by **32**, so are expensive
- Need to use sunlight to prevent local plants from **33**
- Previous programs to provide greenhouses were **34**

New greenhouse

Meets criteria for sustainability

- Simple and **35** to build
- Made mainly from local materials (mud or stone for the walls, wood and **36** for the roof)
- Building and maintenance done by local craftsmen
- Runs solely on **37** energy
- Only families who have a suitable **38** can own one

Design

- Long side faces south
- Strong polythene cover
- Inner **39** are painted black or white

Social benefits

- Owner's status is improved
- Rural **40** have greater opportunities
- More children are educated

TEST 49

SECTION 1 Questions 1-10

Choose your answers from the box and write the correct letter A-J next to Questions 1-5.
Which library matches each description?

- A late night opening
- B study rooms
- C story telling
- D online borrowing
- E a postal book service
- F printing facilities
- G internet training courses
- H weekend opening
- I walk-in internet access

For example

Gosford J

- 1 Ashfield
- 2 Carlton
- 3 Springfield
- 4 Paddington
- 5 Brookside

Questions 6-10

Complete the form below.

Write **NO MORE THAN THREE WORDS AND/OR A NUMBER** for each answer.

LIBRARIES INFORMATION PACK ORDER FORM

Personal details:

Full Name: John

Address: PO BOX 7 Gosford

Date of Birth: 8 1984

Highest education: 9 degree in Accounting

Library section most interested in: 10

SECTION 2 QUESTIONS 11-20

Questions 11-13

Complete the summary below.

Write **NO MORE THAN TWO WORDS** for each answer.

Computer Health and Safety.

Dry eyes can be experienced especially during the 11 However, this problem can easily be combated by using a humidifier. Another solution is to use indoor plants such as the

12 plant, which is very efficient at keeping the air clean and moist. To place an order for either of these, staff members should write their 13..... on one of the forms provided.

Questions 14-16

Complete the sentences below.

Write **NO MORE THAN TWO WORDS AND/OR A NUMBER** for each answer.

14 The optician's visit to the company begins on

15 Staff need to measure their screen to eye distance when they are sitting in their usual

16 Staff who miss the optician's visit can go to her clinic in the

Questions 17-20

Answer the questions below?

Write **NO MORE THAN THREE WORDS AND/OR A NUMBER** for each answer.

17 How long has the company been using laptops?

18 Which department now only uses laptop computers?

19 What risk is associated with connecting a laptop to a desk computer?

20 What does the company offer to people who regularly need to carry laptops?

SECTION 3 QUESTIONS 21-30

Questions 21-23

Complete the notes below.

Write **NO MORE THAN TWO WORDS AND/OR A NUMBER** for each answer.

ESSAY FEEDBACK

Part 1

Good point about how babies 21 differently.

Part 2

Omit the part about Mia being a 22..... baby.

Part 3

Don't use 23

Questions 24-28

What is said about the supporting evidence that the student uses in her essay?

Classify the following evidence as:

A the student's own idea

B paraphrased from another writer

C copied exactly from another writer

Write the correct letter A, B, or C next to questions 24-28. You may choose any letter more than once.

Evidence Used in the Essay.

24 The belief that young babies cannot feel pain

25 How babies respond to their surroundings

26 Examples of different developmental rates

27 Mia's response to physical sensations

28 How babies communicate without words

Questions 29 and 30

Choose the correct letter A, B or C.

29 The student decides to get some additional information about referencing from

- A the library
- B the assignment booklet
- C the university website

30 What still needs to be included in the final draft?

- A a cover page
- B a reference list
- C the total number of words

SECTION 4 QUESTIONS 31-40

Complete the notes below.

Write **NO MORE THAN TWO WORDS** for each answer.

Causes of Language Loss

- i Colonisation e.g. in 31 and 32
- ii Government policy directed at the 33 and schools.

Examples:

Russian children were sent to 34 during the 1950s.

In the US, English and Spanish 35 programs were ended.

- iii Linguistic Imperialism – People associate a language with 36 and 37 and so want to speak it.

Arguments for Preserving Languages

i Linguistic Relativity – Language loss may lead to a reduction in the diversity of 38 that people are able to explain.

ii Cultural Pluralism – Language loss affects:
art forms

39 systems

human relationships

iii Social 40 – Language loss = loss of personal identity.

TEST 50

SECTION 1 Questions 1-10

Complete the notes below.

Write **NO MORE THAN THREE WORDS OR A NUMBER** for each answer.

Example	Answer
Area of interest	city centre
Rents:	from 1 £ to £1000 per month
Number of bedrooms required:	2
Apartment 1:	North Street rent: 3 £ per month including 4
Apartment 2:	5 Road rent: £625 per month
Viewing arrangements:	meet 6 at 7 PLACE: 8 TIME: Pm.
Also required:	Reference letter from 9 one month's rent deposit 10 £ contract fee



SECTION 2 QUESTIONS 11-20

Complete the information below.

Write **NO MORE THAN THREE WORDS OR A NUMBER** for each answer.

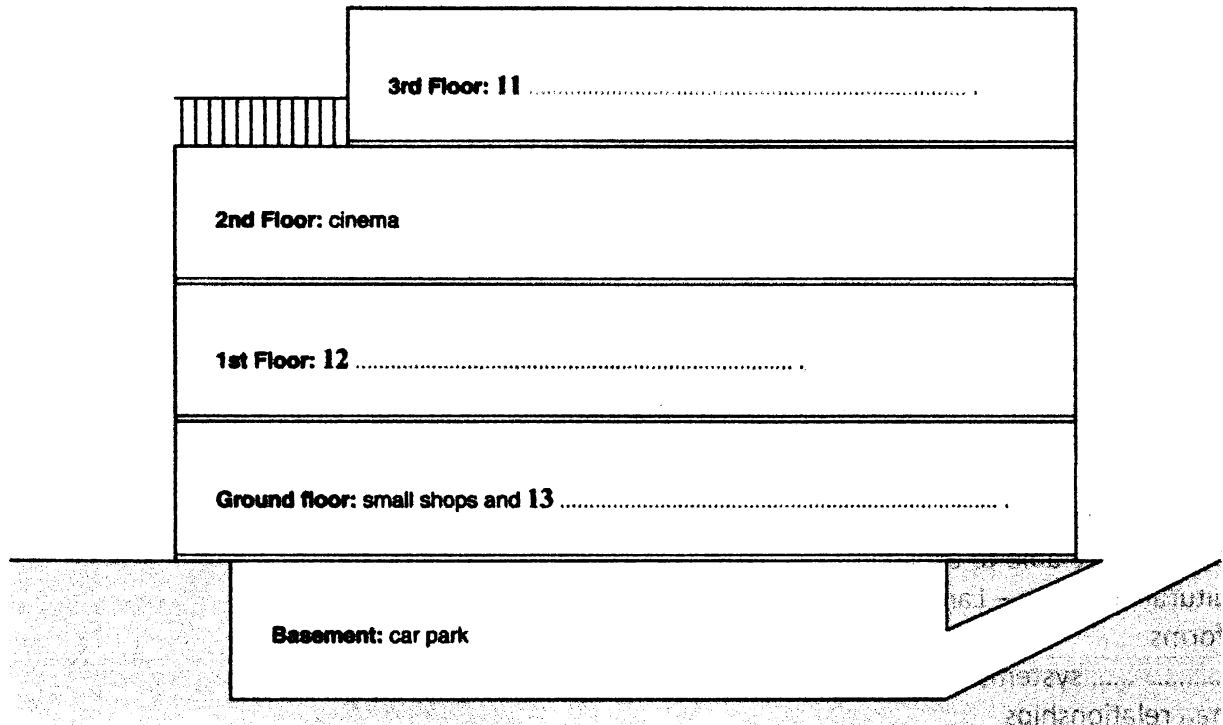

The beach will be 14

This will attract 15

The plans will be on display from Monday, 5th March until 16, 6th 17

Suggestions will be placed in the 18

The next meeting will be on April 19 th.

It will start at 20 pm.

SECTION 3 Questions 21-30

Questions 21-25

Choose the correct letter, A, B or C.

21 Maria's essay is

- A better than her previous one.
- B not quite as good as her previous one.
- C similar to her previous one.

22 The tutor is impressed by

- A the punctuation.
- B the spelling.
- C the style and choice of language.



- 23 The tutor feels that Maria's use of English is
 A generally acceptable
 B very poor
 C perfect
- 24 How does Maria feel about this?
 A She's very sad.
 B She's relieved.
 C She's delighted.
- 25 How does the tutor suggest Maria can improve her spelling?
 A Use a dictionary.
 B Use a computer spell checker.
 C Avoid difficult-to-spell words.

Questions 26-30

What suggestions does the tutor make?

Complete the list below with the correct letters, A, B or C.

- 26 The introduction.....
 27 Information on the railways.....
 28 The quotation from *the Times*.....
 29 The conclusion

- A expand it
 B reduce it
 C delete it

SECTION 4 Questions 31-40

Questions 31 and 32

Choose the correct letters A, B or C.

- 31 The main problem is
 A cats in towns.
 B the poor condition of feral cats.
 C public awareness.
- 32 Emergency veterinary treatment is provided by
 A the government
 B a small number of people
 C nobody

Questions 33-39

Complete the sentences below using **NO MORE THAN THREE WORDS** for each answer.

- 33 Sterilisation is usually performed only on
- 34 Sterilisation is carried out in
- 35 Cats remain there for
- 36 To show that an animal has been sterilized, one

Ways of publishing the issue

Method	Message	When
Poster campaign	"A kitten is not"	now
38	Families may get bored with the responsibility of owning a pet	Perhaps before next Christmas
Newspaper advertisements	Abandoned animals cause problems for other people	39



Question 40

Choose the correct letter, A, B or C.

- 40** A wider problem of feral cats is that they can
- A** injure children
 - B** damage human health
 - C** become infested with parasites.

TEST 51

SECTION 1 Questions 1-10

Questions 1-4

Complete the notes below.

Write **NO MORE THAN TWO WORDS AND/OR A NUMBER** for each answer.

Cheapest properties: £ 1..... per week

Minimum period of contract: 2.....

Office open Saturdays until 3.....

List of properties available on 4.....

Questions 5-7

Choose **THREE** letters A-G.

Which **THREE** things are included for free with every property for rent from Easylet?

- 5.....
- 6.....
- 7.....

- A** heating bills
- B** kitchen equipment
- C** plates and glasses
- D** sheets and towels
- E** telephone
- F** television
- G** water bill

Questions 8-10

Label the map below.

Write the correct letter **A-H** next to questions 8-10.

Where are the following blocks of flats situated?

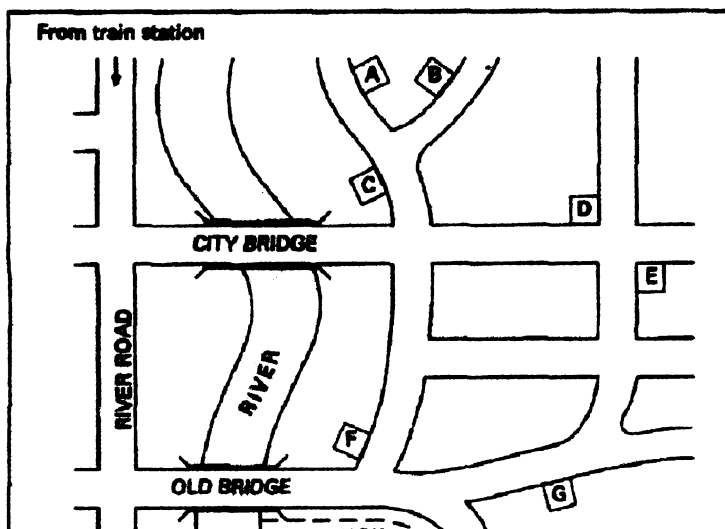

- 8** Eastern Towers
.....
- 9** Granby Mansions
.....
- 10** Busby Garden
.....



SECTION 2 Questions 11-20

Questions 11-12

For each question, choose TWO letter A-E.

11 Which **TWO** activities for school groups need to be booked one week in advance?

- A drama workshops
- B garden sculpture experience
- C painting demonstrations
- D tours for the blind
- E video making

12 Which **TWO** facilities are closed in winter?

- A adventure playground
- B artists' studio
- C cafe
- D mini zoo
- E shop

Questions 13-17

Complete the table below.

Write NO MORE THAN THREE WORDS AND/OR A NUMBER for each answer.

HOLLYLANDS MUSEUM & EDUCATION CENTRE

EXHIBITION	STARTING DATE	POINTS TO REMEMBER
History in Pictures	13	opportunity to go on an old bus
14	19 th September	visitors can use 15 service
16	11 th November	competition – prize: 17 for 2 people

Questions 18-20

Label the plan below.

Choose three answers from the box and write the letters A-F next to questions 18-20.

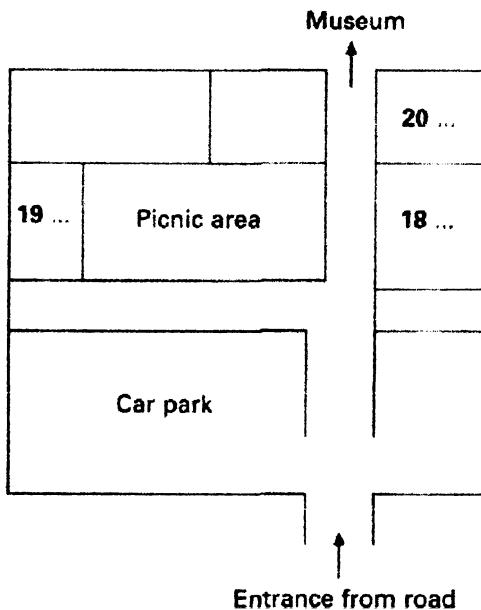

- | |
|---|
| <p>A bicycle parking
 B drinks machine
 C first aid room
 D manager`s office
 E telephones
 F ticket office
 G toilets</p> |
|---|

SECTION 3 **Questions 21-30**

Questions 21-25

Choose the correct letter, A, B or C.

21 Before giving her presentation, Kate was worried about

- A** being asked difficult question
- B** using the projection equipment.
- C** explaining statistical results.

22 During many presentations by students, Martin feels that

- A** the discussion of research methods is not detailed enough.
- B** lecturers do not show enough interest in their students' work.
- C** the student does not make enough eye contact with the audience.

23 What is Kate's opinion of tutorials she attends?

- A** They involve too much preparation.
- B** They should be held more frequently.
- C** they do not have a clear focus.

24 What does Martin intend to do next semester?

- A** make better use of the internet.
- B** improve his note-taking skills.
- C** prioritise reading lists effectively.

25 What problem do Kate and Martin both have when using the library?

- A The opening hours are too short.
- B there are too few desks to work at.
- C The catalogue is difficult to use.

Questions 26-30

Who will do the following tasks?

- A Martin
- B Kate
- C both Martin and Kate

Write the correct letter, **A**, **B** or **C** next to questions 26-30.

- 26** compose questionnaire
- 27** select people to interview
- 28** conduct interviews
- 29** analyze statistics
- 30** prepare visuals for presentation

SECTION 4 Questions 31-40

Questions 31-34

Answer the question below

*Write **NO MORE THAN ONE WORD AND/OR A NUMBER** for each answer.*

- 31** Where was a Stone Age rubbish dump found?
- 32** In Medieval times, what type of waste was most common?
- 33** What did science link with waste?
- 34** Which invention is the biggest problem for the environment?

Question 35-37

*List **THREE** factors which led to the increase in waste.*

*Write **NO MORE THAN TWO WORDS** for each answer.*

- 35**
- 36**
- 37**

A Denmark
B Germany
C Japan
D Switzerland
E UK
F USA

waste

Question 38-40

Which country uses the highest proportion of each method of disposal?

*Choose you answer from the box and write the letters **A—F** next to question **38-40***

- 38** incineration:
- 39** landfill:
- 40** recycling:

TEST 52

SECTION 1 Questions 1-10

Complete the form below.



Write **NO MORE THAN TWO WORDS AND/OR A NUMBER** for each answer.

COMPLAINT RECORD FORM

Holiday booked in name of: 1 First name Last name

Address: Flat 4
2
Winchester S02 4ER

Daytime telephone number: 3

Booking reference: 4

Special offer? Yes, from 5..... company

Insurance? Yes, had 6 Policy

Type of holiday booked: 7 Break

Date holiday commenced: 8

Details of complaint:
- no 9 at station
- a 10 was missing

SECTION 2 Questions 11-20

Questions 11-15

Complete the table below.

Choose your answers from the box and write the appropriate letters A-H next to questions 11-15.

A	driving licence
B	flexible working week
C	free meals
D	heavy lifting
E	late shifts
F	training certificate
G	travel allowance
H	website maintenance

JOB	EMPLOYER	NOTES
Reception Assistant	Park Hotel	<ul style="list-style-type: none"> • 11 • foreign languages • 12
General Assistant	Avenue Hotel	<ul style="list-style-type: none"> • low pay • 13 • 14
Catering Assistant	Hotel 56	<ul style="list-style-type: none"> • free uniform • 15 • outside city



--	--	--

TEMPORARY HOTEL JOBS

Questions 16-20

Complete the flow chart below.

Write **NO MORE THAN TWO WORDS** for each answer.

RECRUITMENT PROCESS

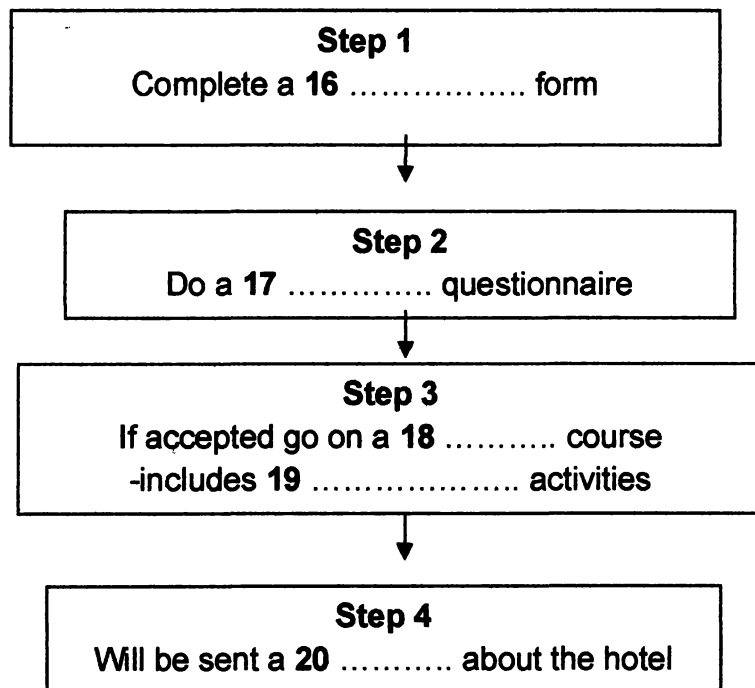

SECTION 3

Questions 21-30

Questions 21-25

Choose the sentences below.

Write **NO MORE THAN THREE WORDS** for each answer.

- 21 David feels that progress on the project has been slow because other members of the group are not
- 22 Jane thinks that were not clearly established.
- 23 Dr Wilson suggest that the group use the available from the Resource Centre.
- 24 David doubts that the research will include an adequate

25 According to Dr Wilson, the is now most important thing to focus on.

26 Jane believes the group could make more use of some

Questions 27-30

Complete the timetable below.

Choose your answer from the box and write the letters A-H next questions 27-30.

- A Compare photographs at newspaper offices.
- B Interview a local historian.
- C Listen to tapes in the City Library.
- D Study records of shop ownership.
- E Take photographs of the castle area.
- F Talk photographs of the castle area.
- G Tour city centre using copies of old maps.
- H Visit an exhibition at the University Library.

MON – WED FIELD TRIP TO CAMBRIDGE		
Mon 22 nd	am	arrive at hotel
	pm	27
Tues 23 nd	am	28
	pm	free time
Wed 24 th	am	29
	pm	30

SECTION 4 Questions 31-40

Questions 31-35

Complete the summary below.

Write **NO MORE THAN TWO WORDS** for each answer.

THE LONDON EYE

The architects who designed the London Eye drew it for a **31** in 1993. Subsequently, they formed a partnership with **32** to develop the project. As the biggest observation wheel ever built, its construction involved 1.700 people in five countries. Most of its components had to be **33**, and delivering them had to be coordinated with the **34** in the River Thames. On average 350 hours a week are spent on maintenance of the Eye, and only **35** is used to clean the glass.

Questions 36-40

Label the diagram below.

Write **NO MORE THAN TWO WORDS** for each answer.

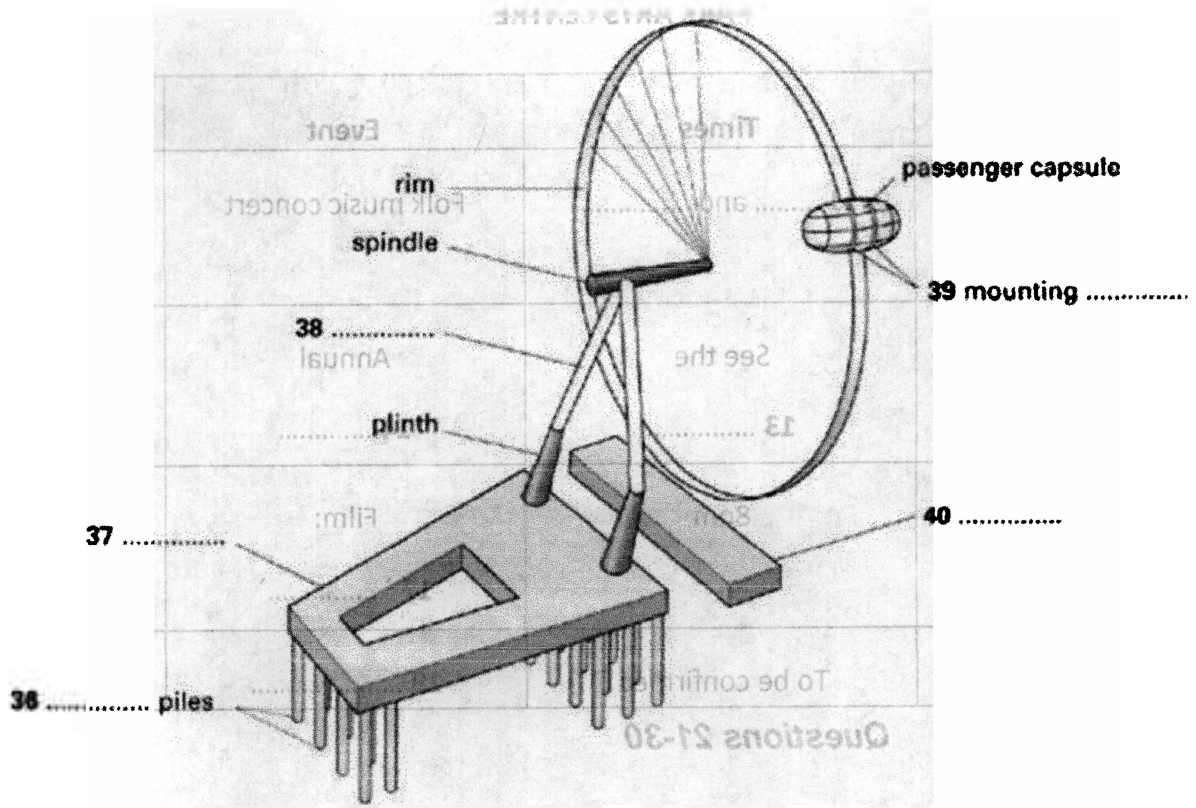

TEST 53

SECTION 1 Questions 1-10

Answer the questions below.

Write **NO MORE THAN THREE WORDS AND/OR A NUMBER** for each answer.

- 1 How many members does the cycling club have currently?
- 2 How much does Youth Membership cost?
- 3 From whom must you get a signature when applying to join?
- 4 How long does it take to process a membership application?.....
- 5 How often do family rides take place?
- 6 How long are the Saturday rides usually?
- 7 What must you get for your bike?
- 8 When is the next camping tour?
- 9 What is happening on May 5th?
- 10 How much discount do members get at Wheels Bike Shop?

SECTION 2 Questions 11-20

Complete the timetable below.

Write **NO MORE THAN THREE WORDS AND/OR A NUMBER** for each answer.

Dates	Times	Event	Notes
18-24 Feb	11 and	Folk music concert	Can get a 12 in sh
1-8 March	See the 13	Annual 14	Groups from 15
16	8pm	Film: 17 `.....`	Talk by the 18
2 April	To be confirmed	19	It will be 20

SECTION 3 **Questions 21-30**

Questions 21-25

What opinion is expressed about each dissertation?

Choose your answer from the box and write letters A – I next to questions 21-25.

- 21 Twentieth Century Architecture
- 22 Modern Construction
- 23 Steel, Glass and Concrete
- 24 The Space We Make
- 25 Change and Tradition

- A It has an inadequate index.
- B It contains unusual illustrations.
- C It is too detailed in places.
- D It presents clear arguments.
- E It contains diagrams which are not clear.
- F It omits important historical facts.
- G It is poorly translated.
- H It contains useful background information
- I It is not suitable for new students.

Questions 26-30

Complete the flow chart below.

*Write **NO MORE THAN THREE WORDS** for each answer.*

BEN'S PROGRAMME

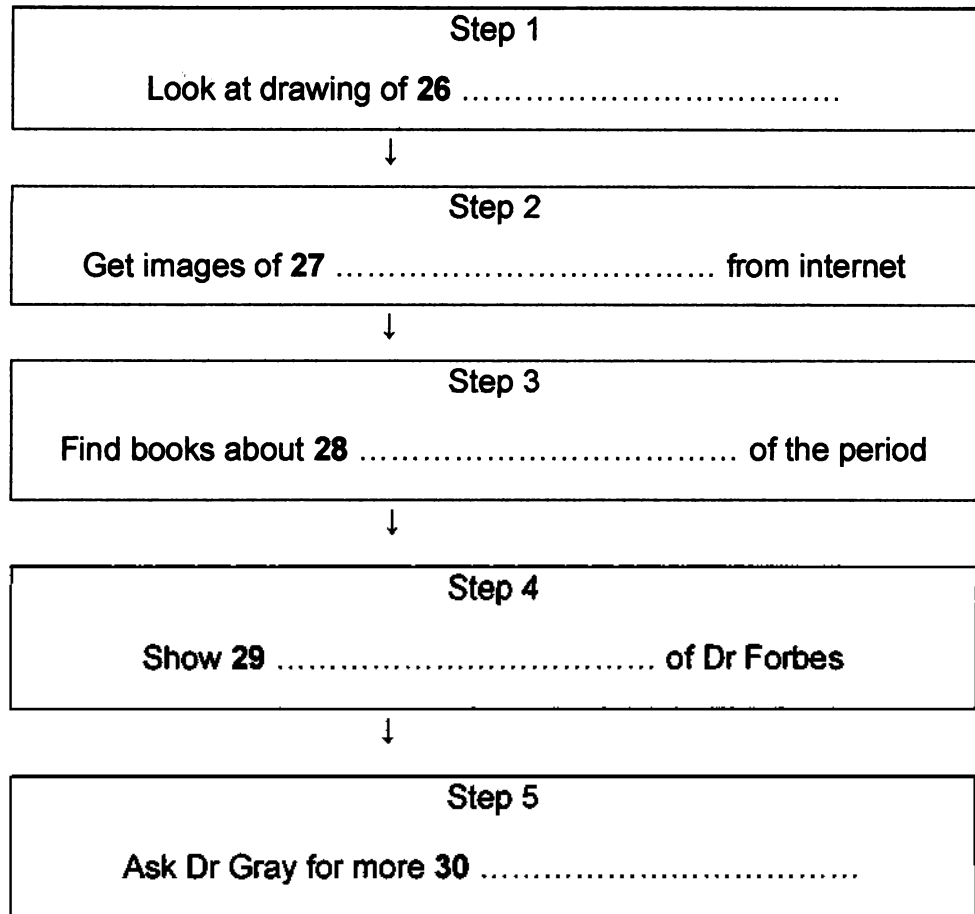

SECTION 4

Questions 31-40

Complete the sentence below.

*Write **NO MORE THAN TWO WORDS** for each answer.*

- 31 Rival cameras were claimed to less than the Cinematographer.
- 32 In Russia, on the occasion, the Cinematographer was suspected of being a
- 33 Early filming in Russia led to the cinema of a new approach to
- 34 One problem for historians is not knowing whether early equipment as it was claimed.
- 35 Mary encountered difficulties achieving the of strips of photographic paper.
- 36 The of comic strip influenced the way film were planned.
- 37 Documentaries used shots before fiction films did.
- 38 The popularity of films led to increased number of shots.
- 39 When filming, the screen might be divided.
- 40 As films became more complex, became an important part of film-making.



TEST 54

SECTION 1 Questions 1-10

Complete the form below.

Write NO MORE THAN THREE WORDS AND/OR A NUMBER for each answer.

**ABLE EMPLOYMENT AGENCY
APPLICATION FORM**

Full name: 1

Address: 2 Melford MF3 5JB

Contact number: 3

Qualifications: (a) A levels
(b) 4

(c) 5

Previous experience: (a) general work in a 6 (3 months)
(b) part-time job as a 7

Interests: (a) member of a 8

(b) enjoys 9 (10 years)

Date available: 10

SECTION 2 Questions 11-20

Questions 11-16

Complete the sentences below.

Write NO MORE THAN TWO WORDS for each answer.

The hotel

- 11 You must book in advance.
- 12 There are some interesting in the lounge.

Activities

- 13 The visit to the has been cancelled.
- 14 There will be a talk about from the area on Saturday.
- 15 The visit to the will take place on Sunday.
- 16 There is a collection of in the art gallery.

Questions 17-20

Label the map below.

Write the correct letter A-I next to questions 17-20.

Where are the following places situated?

- 17 Park Hotel
- 18 Internet Café
- 19 Tourist Information Office
- 20 Royal House Restaurant

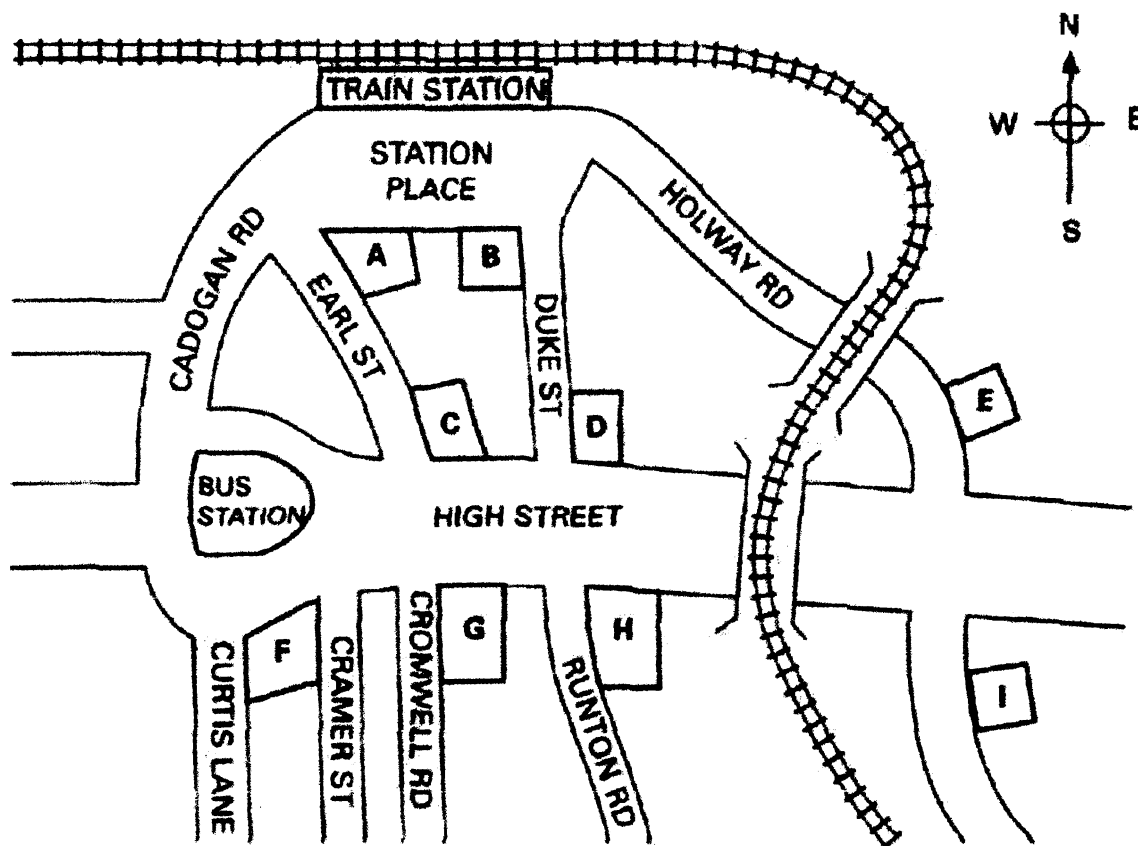

SECTION 3 Questions 21-30

Questions 21-26

Write the correct letter, A, B or C next to questions 21-26.
At which college are the following features recommended?

- A at Forth College
 - B at Haines College
 - C at both Forth and Haines Colleges
- 21 student support services
- 22 residential accommodation
- 23 on-line resources
- 24 libraries
- 25 teaching staff
- 26 research record

Questions 27-30

Choose the correct letter, A, B or C.

- 27 David is concerned that he may feel
- A unmotivated.
 - B isolated.
 - C competitive
- 28 In the future, Dr Smith thinks David should aim to
- A do further research.
 - B publish articles.
 - C get teaching work.

29 What does Dr Smith think has improved masters' study in recent years?

- A** the development of the internet.
- B** the growth of flexible courses.
- C** the introduction of changes in assessment

30 David would like to improve the way he

- A** takes notes in lectures.
- B** writes up assignments.
- C** manages his time.

SECTION 4 **Questions 31-40**

Questions 31-37

Complete the table below.

Write **NO MORE THAN TWO WORDS** for each answer.

Type of writing	Notes	Tips
Short stories	3 basic styles	start with a 31
Non - fiction	biographies often popular	tell publishers about you 32
Articles	advice articles work well	write for a 33
Poetry	meaning shouldn't be too 34	read your poems aloud
Plays	movements usually decided by the 35	learn about acting
Radio	BBC publishers handbook	try 36
Children's literature	illustrations important	decide on an 37

Question 38-40

Choose the correct letter, A, B or C

38 What is disadvantage of first person narration in novels?

- A** It makes it harder for the main character to be interesting.
- B** It is difficult for beginners to do well.
- C** It limits what can be described.

39 What is mistake when writing novels?

- A** failing to include enough detail
- B** trying to explain ironic effects
- C** including too many characters

40 In order to make dialogue seem natural, writers should

- A** make recordings of real conversations.
- B** include unfinished sentences.
- C** break up long speeches.

TEST 55

SECTION 1 Questions 1-10

Questions 1-6

Answer the questions below.

Write **NO MORE THAN TWO WORDS AND/OR A NUMBER** for each answer.

**GROUP TRIP
TO TIDBOROUGH**

- 1 How far is it from the youth hostel to the city centre?
- 2 What is the website address of the youth hostel?
- 3 What event is taking place on March 22nd?
- 4 Who does the concert feature?
- 5 What exhibition starts on March 24th?
- 6 What will be closed in March?

Questions 7-10

Choose the correct letters A-C.

7 When does the train ride depart?

- A 9.00
- B 9.15
- C 9.30

8 Where is it recommended to buy tickets?

- A at the tourist
- B at the station
- C at the youth hostel

9 How much is the group discount?

- A 10%
- B 15%
- C 20%

10 How long does the excursion last?

- A 3 hours
- B 3.5 hours
- C 4 hours

SECTION 2 Questions 11-20

Questions 11-13

Choose the correct letter, A, B or C.

11 Which chart shows the company's sales figures for the last five years?

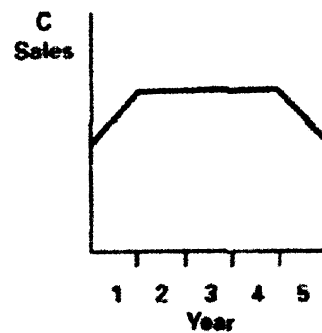
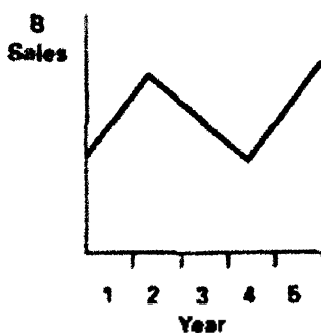
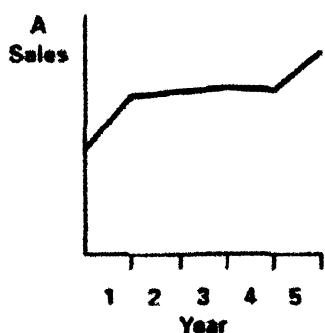



12 Which chart shows the relationship of three departments this year?

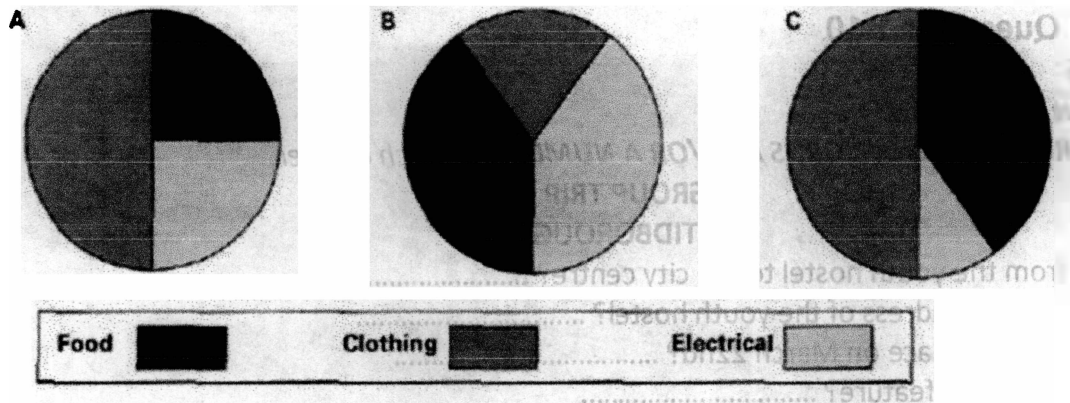

13 Which chart shows numbers of temporary staff in the company?

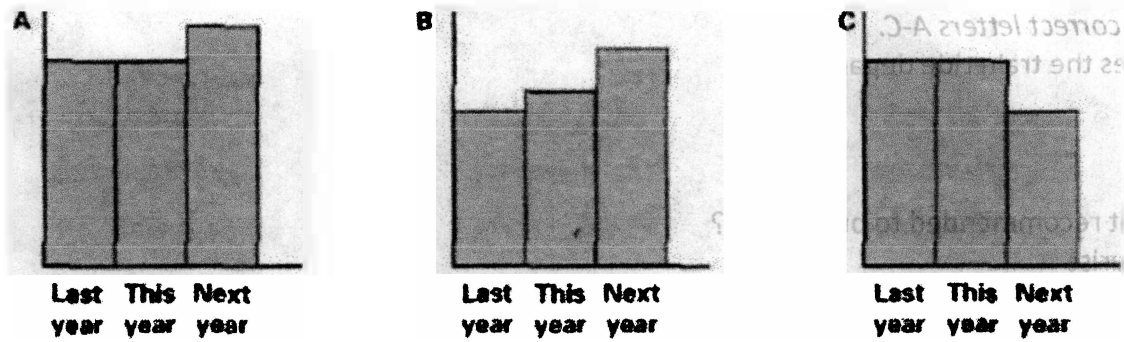

Questions 14-19

Complete the notes below.

Write **NO MORE THAN TWO WORDS** for each answer.

- Company's mission statement: '14 for customers'
- In case of problems, always ask your 15 for help
- Important for customers to have a 16 Experience
- Tell customers about 17 goods
- Read the 18 every month
- Must attend 19 on Thursdays

Question 20

Choose **TWO** letters, A-E.

20 Which **TWO** things must be done today?

- A complete form
- B get security pass
- C register for discount
- D show certificates
- E watch information video

SECTION 3 Questions 21-30

Questions 21-24

Which action does each type of penguin do?

Choose your answer A-G from the box below and write them next to questions 21-24.

- 21 Gentoo
- 22 Rockhopper
- 23 Magellanic
- 24 King

- A always hesitate before jumping
- B avoid climbing if possible
- C lean backwards when calling
- D move around at night
- E use its bill when climbing
- F usually look twice at things
- G walk with its flippers pointing downwards

Questions 25-27

Write NO MORE THAN TWO WORDS for each answer.

- 25 How do penguins usually sleep?
- 26 What do a Rockhopper's yellow feathers do when it is angry?
- 27 What do penguins recognize in the Skua's wings?

Questions 28-30

Complete the summary below.

Write NO MORE THAN TWO WORDS for each answer.

Penguins prefer to swim in groups because it makes easier to **28** When they are on land, they appear to be **29** The majority of species are characterized by their **30**, which makes them particularly interesting for humans to study.

SECTION 4 Questions 31-40

Complete the sentence below.

Write NO MORE THAN TWO WORDS for each answer.

- 31 Governments have been mistaken to slums.
- 32 There is often a lack of concerning housing projects.
- 33 Housing policies which are based on principles of are particularly effective.
- 34 Some should always be provided by governments.
- 35 Migrants will only in housing if they feel secure.
- 36 Governments often underestimate the importance of to housing projects.
- 37 The availability of is the starting point for successful housing development.
- 38 Urbanization can have a positive effect on the of individuals.
- 39 The population size of cities enables a range of to occur.
- 40 City living tends to raise the level of among people.

TEST 56

SECTION 1 Questions 1-10

Questions 1-7

Complete the form below.

Write **NO MORE THAN TWO WORDS AND/OR A NUMBER** for each answer.

GO-TRAVEL BOOKING FORM

Name 1(Last) (First)

Source of enquiry saw ad in 2 Magazine

Holiday reference: 3

Number of people: 4

Preferred departure date: 5

Number of nights: 6

Type of insurance: 7

Questions 8-10

Choose **THREE** letters A-H.

Which **THREE** options does the woman want to book?

- A arts demonstration
- B dance show
- C museums trip
- D bus tour at night
- E picnic lunches
- F river trip
- G room with balcony
- H trip to mountains

8

9

10

SECTION 2 Questions 11-20

Questions 11-17

Complete the notes below.

Write **NO MORE THAN THREE WORDS AND/OR A NUMBER** for each answer.

RUN-WELL CHARITY

Background to Run-Well charity

Set up in 11

Aim: raise money for the 12

Race details

Teams to supply own 13

Teams should 14 together

Important to bring enough 15

Race will finish in the 16

Price given by the 17

Questions 18-20

Choose **THREE** letters A-H.

Write **THREE** ways of raising money for the charity are recommended?

- A badges
- B bread and cake stall
- C swimming event
- D concert
- E door-to-door collecting
- F picnic
- G postcards
- H quiz
- I second-hand sale

18

19

20

SECTION 3 Questions 21-30

Questions 21-26

What do the students decide about each topic for Joe's presentation?

- A Joe will definitely include this topic.
- B Joe might include this topic.
- C Joe will not include this topic.

Write the correct letter, A, B or C next to questions 21-26

- 21 cultural aspects of naming people
- 22 similarities across language in naming practices
- 23 meaning of first names
- 24 place names describing geographic features
- 25 influence of immigration on place names
- 26 origins of names countries

Questions 27-30

Complete the summary below.

Write **NO MORE THAN TWO WORDS** for each answer.

Researches showed a group of students many common nouns, brand names and **27** Students found it easier to identify brand names when they were shown in **28** Researches think that **29** is important in making brand names special within the brain. Brand names create a number of **30** within the brain.

SECTION 4 Questions 31-40

Complete the form below.

Write **NO MORE THAN TWO WORDS** for each answer.

Gas balloons

Uses:

- instead of **31** in the US civil war
- to make **32**
- to **33** for search
- as part of studies of **34**

Hot air balloons

Create less **35** than gas balloons

Airships

Early examples had no **36** for crew

To be efficient, needed a **37**

Development of large airships stopped because of:

- success of **38**
- series of **39**

Recent interest in use for carrying **40**

TEST 57

SECTION 1 Questions 1-10

Questions 1-7

Complete the form below.

Write **NO MORE THAN TWO WORDS AND/OR A NUMBER** for each answer.

Hotel Columbus Guest Information

First name: **1**

Surname: **2**

Street address: **3** 45.....

Town/City: Lewes

State/County: East Sussex

Zip/Postcode: **4**

Country: United Kingdom

Email address: **5**@yahoo.co.uk

ID type: **6**.....

ID number: 874236195

Number of nights: **3**

Room: **7**

Questions 8-10

Label the map below.

Write the correct letter A-H next to questions 8-10.

Where are the following places situated?

- 8** museum
- 9** art gallery
- 10** conference center

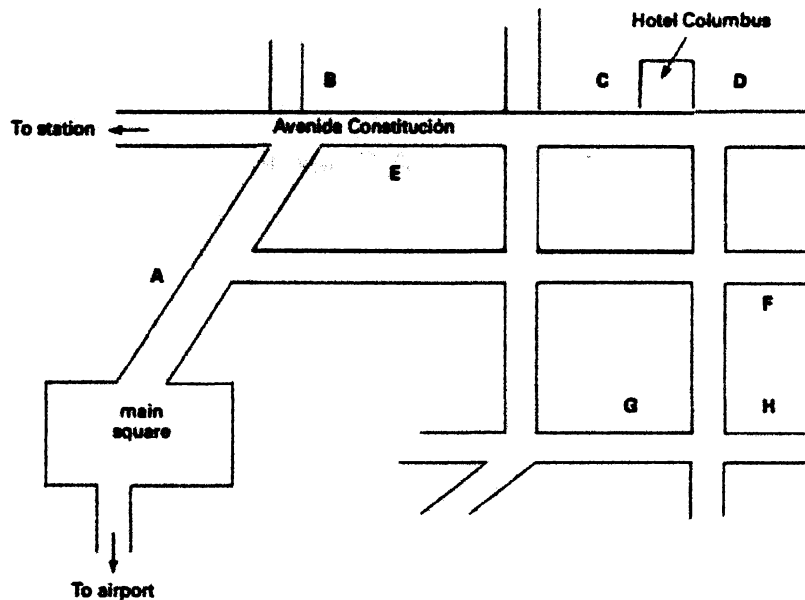

SECTION 2 QUESTIONS 11-20

Questions 11-14

Complete the notes below.

Write **NO MORE THAN TWO WORDS** for each answer.

Benefits of allotment gardening

- conventional gardens too small / can grow far more on own plot of land
- very sociable / communal – people from totally different **11** come together
- good exercise – costs far less than **12** membership!
- pleasure & sense of achievement – both mental & physical benefit
- environmental benefit – provide urban areas with essential **13** for wildlife
- reduction of **14** due to less traffic transporting produce

Questions 15-17

List **THREE** advantages of allotment-grown food.

Write **NO MORE THAN TWO WORDS** for each answer.

15

16

17

Questions 18-20

Label the plan now.

Choose **THREE** answers from the box and write the letter A-G next to the questions 18-20.

- A compost bin
- B flower bed
- C glass house
- D grass walkway
- E pond
- F stone sink
- G vegetable bed

- 18
- 19
- 20

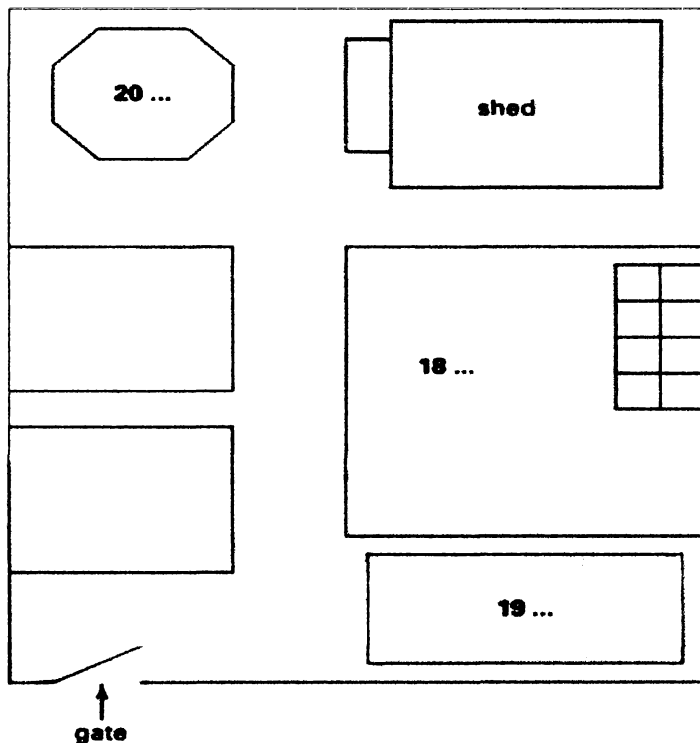

SECTION 3 QUESTIONS 21-30

Questions 21 -24

Answer the questions below.

Write NO MORE THAN ONE WORD for each answer.

- 21 What course does Lily want to study next year?
- 22 Where is Lily probably going to study?
- 23 What course are Mark and Lily studying on now?
- 24 What does Lily think Mark might be afraid of?

Questions 25-30

Who makes the following points?

Write the correct letter, **A**, **B** or **C** next to questions 25-30.

- A Mark
- B Lily
- C Tutor

- 25 most artists do not earn much money
- 26 renting studio space can be very expensive
- 27 art schools help promote young artists' work
- 28 some people disapprove of artistic courses
- 29 young artists need regular evaluation of their work
- 30 amateur artists have an unrealistic view of their work

SECTION 4 QUESTIONS 31-40

Questions 31-35

Complete the summary below.

*Write **NO MORE THAN TWO WORDS** for each answer.*

Laughter in psychological therapy

Most people acknowledge that any treatment involving psychological therapy **31** is and do not immediately associate it with laughter. People normally laugh when something is funny, so assume that laughter is naturally related to **32** The result is that laughter as a **33** is not recognized as it should be. Laughter is not simply a reaction to finding something amusing. A similar **34** may be triggered by a range of negative feelings. If we understand this, we will no longer **35** by people laughing unexpectedly.

Questions 36-40

Choose the correct letter A, B or C.

36 What does the speaker say about cathartic psychotherapy?

A There is a limit to how much pain laughter releases

B Laughter releases various negative emotions

C It is possible to estimate how much pain is released each time a person laughs

37 According to the lecture, losing self-control

A is often beneficial

B is acceptable when we are children

C makes feelings of pain and sadness last longer

38 Which of the following regarding recent research does the lecturer NOT suggest?

A The way people store emotions is more physical than mental

B People find it easier to laugh than to express other emotions

C Laughing replaces the need to cry or get angry

39 The lecturer feels that people in the medical professions must

A encourage patients to understand the seriousness of their conditions

B recognize that people do not necessarily laugh to hide true feelings

C stop patients laughing inappropriately

40 What does the lecturer conclude by saying about the catharsis of laughter?

A It helps people to forget distressing memories

B People find themselves in a position of control

C People can benefit from seeing the humor in unfortunate circumstances

TEST 58

SECTION 1 Questions 1-10

Questions 1-5

Complete the table below.

*Write **NO MORE THAN TWO WORDS OR A NUMBER** for each answer.*



Name of library	Location	Opening times	Other information
Bailey Library	Parkville Campus	8.30 a.m. – 1 p.m. weekdays	Popular with students
Brown Library	Near Stratton Street and 2	7.00 a.m. – 2.00 a.m. daily	Open to 3 students only
RMIT Library	Level 5, Building 8, 4 Swan Street	10.00 a.m. – 12 midnight Monday to Friday 10.00 am – 5p.m. Saturdays and Sundays	Good internet facilities

Questions 6-10

Complete the flow chart below.

Write **NO MORE THAN ONE WORD** for each answer.

Process of booking a computer

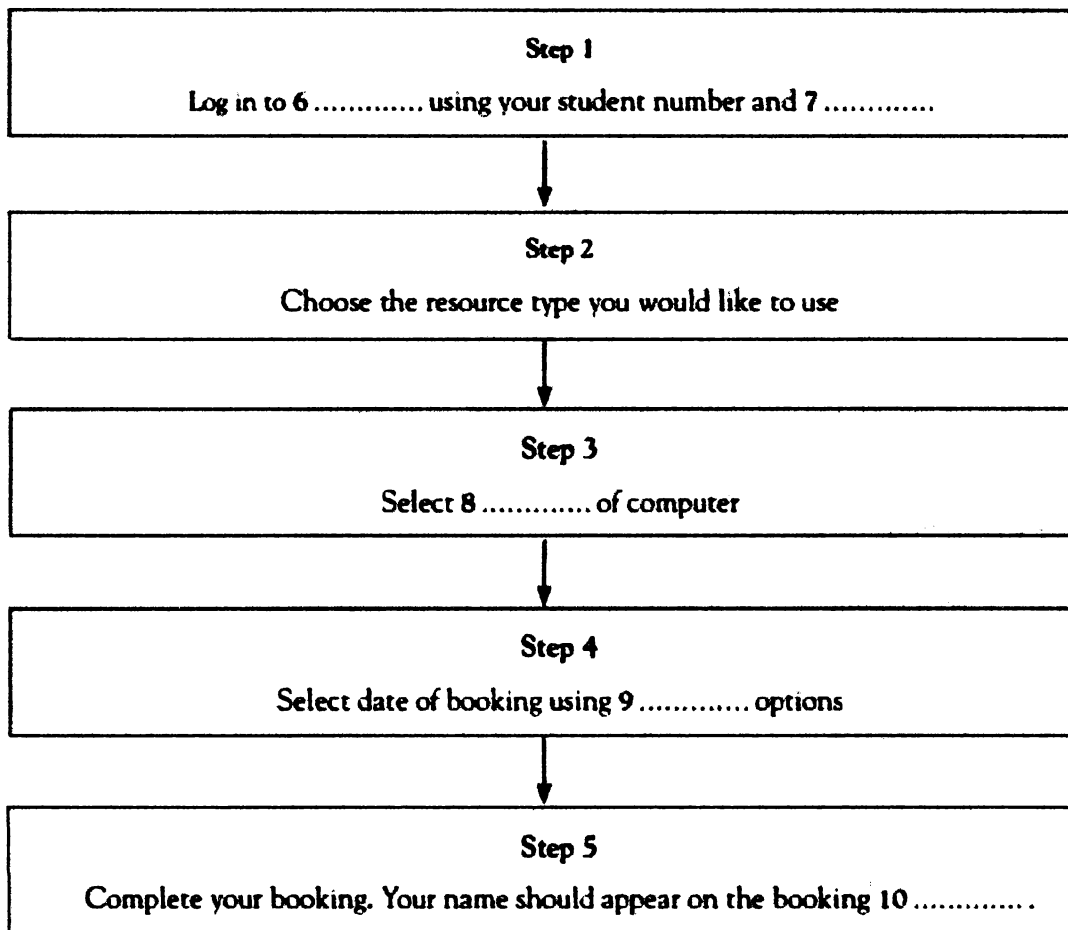

SECTION 2 QUESTIONS 11-20

Questions 11-14

Choose **TWO ANSWERS**.

11 Doors Open

- A is an annual event
- B lasts for one week
- C is a free event
- D happens in spring
- E is more than one hundred years old

12 The Observatory

- A is situated in Edinburgh
- B was built twenty years ago
- C regularly participates in the Doors Open event
- D is one hundred and twelve years old
- E is open to visitors every day of the year

13 Planetarium Shows

- A take place twice a day
- B are more popular on Saturday
- C run on Saturday and Sunday
- D run four times a day
- E finish at half past ten

14 All tickets

- A must be booked in advance
- B are already sold out
- C are on sale at the information point
- D must be booked online
- E are available for purchase from midday

Questions 15-20

Complete the sentences.

Use **NO MORE THAN TWO WORDS** for each answer.

15 The tour of the telescope dome includes access to the of the building.

16 Tour participants are advised to have suitable

17 Visitors to the Crawford Collection can see items from the astronomical on display.

18 The children's craft workshops take place in the

19 During the craft workshops children can construct a model of a

20 Children also have the opportunity to colour a

SECTION 3 QUESTIONS 21-30

Questions 21-23

Choose **THREE** letters, A-G.

Which **THREE** examples of space junk are mentioned by the speaker?



- 21
22
23

- A cans
- B cooling tanks
- C metal plates
- D metal crews
- E paint
- F satellites
- G whole rockets

Questions 24-26

Which country is responsible for depositing the following percentages of space junk?
Choose your answers from the box. Write the letters A-E next to questions 24-26.

- 24 28%
25 29%
26 37%

- A China
- B Europe
- C India
- D Russia
- E United States

Questions 27-30

Complete the table below.

Choose your answers from the box and write the appropriate letters A-I next to questions 27-30.

- A a grown up gorilla
- B a double decker bus
- C the desert
- D Eastern Australia
- E the 1980s
- F 2001
- G 100 tonnes
- H the South Pacific

Space Junk - Satellites

Name of satellite	Country of origin	Notes
UARS	United States	<ul style="list-style-type: none"> size and weight of 27..... was in space for two decades
Skylab	United States	<ul style="list-style-type: none"> ended up in 28 Weight of 29.....
Mir	Russia	<ul style="list-style-type: none"> Larger than UARS Ended up in 30

SECTION 4 QUESTIONS 31-40

Questions 31-35

Complete the table below.

Use **NO MORE THAN TWO WORDS** for each answer.

Supermarket layout

Name of area	Location of area	Purpose of area
Decompression zone (sometimes called the 31 zone)	Situated immediately inside the entrance and is generally free of 32	To encourage the customer to 33 to the supermarket
34 Zone	Situated on the right side near the front door	To encourage customers to relax before they start shopping
Power aisle	The central route through the supermarket	To display 35

Questions 36-40

Which items do the following sentences apply to?

Write the correct letter, A, B, C, D, or E, next to questions 36-40.

- A fruit and vegetables
- B bread and milk
- C cheap tinned foods
- D flowers
- E sunglasses

- 36 They are referred to as distress goods
- 37 They are always located at the front of the supermarket
- 38 They are referred to as destination goods.....
- 39 They are normally located below eye level
- 40 They are often located at the check-out

TEST 59

SECTION 1 Questions 1-10

Questions 1-3

Choose **THREE** letters A-G

Which of the following reasons does Kate mention for wanting a cleaner?

- A A cleaner can do a more thorough job than she can
- B Her husband is especially busy at work
- C There has recently been damage to the house.
- D Her husband is unwilling to do housework.
- E She and her husband cannot cope with all their responsibilities.
- F Other people she knows have a cleaner.

G The price of cleaning has dropped.

Questions 4-10

Complete the notes below.

Write **NO MORE THAN TWO WORDS OR A NUMBER** for each answer.

4

Reliable home cleaning

Call 5 on 07984 6

Top quality cleaning

7

Garden care 8 £..... per hour

Thorough spring clean 9 £.....

10 available

Call now – and put your feet up!

SECTION 2 QUESTIONS 11-20

Questions 11-14

Write **NO MORE THAN TWO WORDS** for each answer.

- 11 Some parents are worried that the size of will be reduced.
- 12 Any that parents give is welcomed.
- 13 An of changes and progress will be available each week online.
- 14 The speaker was keen to balance the need for with other school requirements.

Question 15-20

Label the plant below.

Choose **THREE** answers from the box and write the letter A-I, next to questions 15-20.

- | | |
|----------|----------------------|
| A | Snack bar |
| B | Children's toilets |
| C | Year 6 classroom |
| D | Bicycle baby |
| E | Nursery |
| F | Staff toilets |
| G | Hall |
| H | Year 5 classroom |
| I | Extra house facility |

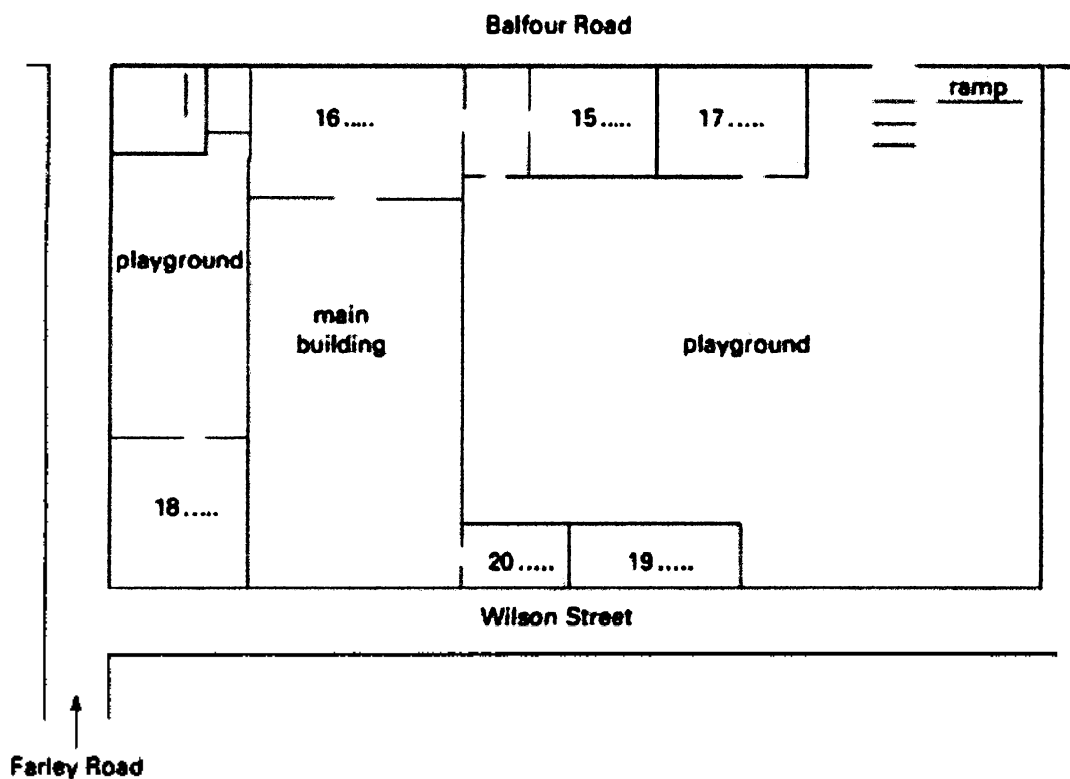

SECTION 3 QUESTIONS 21-30

Question 21-23

Choose the correct letter, A, B or C.

- 21 How does Matt feel about taking a gap year?
 A It's an option firmly in his plans.
 B It would be a waste of time.
 C It's something he might consider.
- 22 Sandy wants to do a gap year to
 A see as much of the world as possible.
 B gain experience and knowledge.
 C make money.
- 23 Sandy's parents
 A think she has made the right decision.
 B are worried about the future
 C feel that she may regret her choice.

Question 24 and 25

Which of the following ideas do the students mention as benefits of taking a gap year?

Choose **TWO** letters A-F

- A young people becoming more mature
 B students becoming experts on certain topics
 C students having clearer goals
 D fluency in a foreign language



- E an extra sense of spirit and adventure
- F a greater likelihood of academic success

Questions 26-30

Complete the table below.

Write **NO MORE THAN TWO WORDS** from the recording for each answer.

Australia	excellent coast 26 lifestyle cosmopolitan cities	27 of the journey
Ghana	rewarding life experience acquisition of 28	X
Nepal	Sense of achievement 29 of life	quality of 30

SECTION 4 QUESTIONS 31-40

Questions 31-34

Complete the summary.

Use **NO MORE THAN THREE WORDS** for each answer.

A predator is any animal that hunts and kills prey for food. The prey is not necessarily a 31 For many animals, 32 fills most of their time. Predators and prey can change roles – some animals find themselves in two different places on 33 Defence mechanisms are an important contributor to survival. 34 can be the result when species lack defence mechanisms.

Questions 35-40

Which creature uses each defence mechanisms?

Choose your answer from the box and write the letters A-I next to questions 35-40.

A	bird
B	butterfly
C	chameleon
D	frog
E	mollusk
F	porcupine
G	skunk
H	turtle
I	zebra

- 35 moves more quickly than a predator
- 36 frightens a predator
- 37 appears different when in a group
- 38 may injure a predator
- 39 produces a substance in which it can hide
- 40 can kill a predator

TEST 60

SECTION 1 Questions 1-10

Questions 1-4

Choose the correct letter, A, B or C.

- 1 The workshop takes place on
 - A the 5th
 - B the 6th
 - C the 16th
- 2 The maximum number of participants is
 - A five
 - B twelve
 - C fifteen
- 3 The workshop lasts for
 - A half an hour
 - B one hour
 - C over an hour
- 4 Each workshop participant must contribute
 - A £2
 - B £5
 - C £10

Questions 5 and 6

Choose TWO letters, A-F.

Which TWO items must participants bring to the workshop?

- A a bag
- B a container
- C floral supplies
- D paper
- E penknife
- F scissors

Questions 7-10

Complete the booking form below.

Write ONE WORD AND/OR A NUMBER for each answer.

Japanese Floral Art Workshop Booking Form

Participant Details

First name: **7**

Surname: **8**.....

Contact telephone number: 9
Email address: 10 @yahoo.com

SECTION 2 QUESTIONS 11-20

Questions 11-12

List **TWO** materials which are suitable for wrist rests.

11

12

Questions 13-17

Complete the notes below.

Write **NO MORE THAN TWO WORDS** for each answer.

Choosing a wrist rest:

- Make sure it is free of **13**

Advantages of a wrist rest:

- can help the wrist to maintain a **14** and neutral position during computer use
- prevents the hands **15** the edge of the keyboard
- can reduce pain in the **16** and shoulders

Disadvantages of wrist rest:

- may increase pressure on the **17** of the wrist

Questions 18-20

Answer the questions below.

Write **NO MORE THAN THREE WORDS AND/OR A NUMBER** for each answer.

18 How far should the wrist rest be placed from the keyboard?

19 Which parts of the hand should you place on the wrist rest?

20 When is the best time to use a wrist rest?

SECTION 3 QUESTIONS 21-30

Questions 21-23

Choose the correct letter A, B or C.

21 What is Hannah doing research on?

A domestic waste

B industrial waste

C construction waste

22 How does Hannah feel about the amount of waste?

A not surprised

B angry

C shocked

23 What proportion of food purchased goes to waste?

A one quarter

B one third

C one half

Diyorbek's

IELTS

Questions 24-30

Complete the table below with **NO MORE THAN ONE WORD AND/OR A NUMBER**.

Daily domestic food waste in the UK

Food	Quantity
Pots of yoghurt	24 million
Whole 25	5,500
Slices of bread	26 million
27	0.7 million
Packets of biscuits	28 million
Whole 29	5.1 million
Whole apples	4.4 million
Whole 30	2.8 million

SECTION 4 QUESTIONS 31-40

Label the diagram below.

Write **NO MORE THAN TWO WORDS** for each answer.

Motivational Pyramid – Hierarchy of Needs

Tier 5

encouragement to work on individual 40

39

development of skills and talents

Tier 4

receipt of rewards such as free mobile phones and 38

37

recognition of hard work

Tier 3

Social needs

involvement in decision making and discussion of 36

opportunities for social interaction and 35

Tier 2

good job terms such as employment contract and
a 34 in old age

33 needs

Tier 1

Basic physical needs

good working conditions such as access to staff canteen and 32

money for food and 31

TEST 61

SECTION 1 Questions 1-10

Questions 1-4

Complete the notes below.

Write **NO MORE THAN TWO WORDS AND/OR A NUMBER** for each answer.

York Car Pool

Complaint from Julie Gold – membership

No. 1.....

Car – grey 2 YPT723S

Location – 3

Booking 11/03 at 4 a.m.

Questions 5-10

Choose the correct letter A, B or C.

5 What is the caller's first complaint?

A The car she wanted to use was not in the correct location

B She had to phone the Car Pool to ask where the car was

C Another Car Pool member still had the car

6 The Car Pool advisor

A thinks that the previous car user did something wrong

B assumes that the previous car user was not able to park in the correct place

C agrees that the previous car user acted selfishly

7 The caller says that she

A shouts when she is angry with other drivers

B makes it known that she expects another driver to move

C is prepared to wait if she cannot park immediately

8 Why is the caller unhappy about the state of the car?

A It was dirty

B It had been damaged

C There was rubbish inside

9 What is the caller's final complaint?

A it was difficult to start the car

B She could not find the keys

C There was not enough petrol in the tank

10 The Car Pool advisor says that

A the caller will not be charged for today's booking

B he will credit the caller's aunt

C the incident will be reported on the Car Pool website

SECTION 2 QUESTIONS 11-20

Questions 11-13

Complete the flow-chart below.

Use **NO MORE THAN THREE WORDS** for each answer.



A Brief History of Archery

Archery first used to hunt and in warfare – bows were straight
String removed from curved bows when 11



All cultures had bows and arrows – 12 best known for using them



Advent of 13 saw a decline in use of bows and arrows



Archery as recreational activity grew in popularity

Questions 14 and 15

Complete the summary below.

Use **NO MORE THAN TWO WORDS** for each answer.

Safety procedures

All equipment must be used properly and safely. Archers must not think of the bows and arrows as 14 Nobody is allowed to enter the 15 until told to do so by the group supervisor. Each participant must use their weapon only when instructed to do so.

Questions 16-20

Label the diagrams below.

Choose **FIVE** answers from the box and write the letters A-J next to questions 16-20.

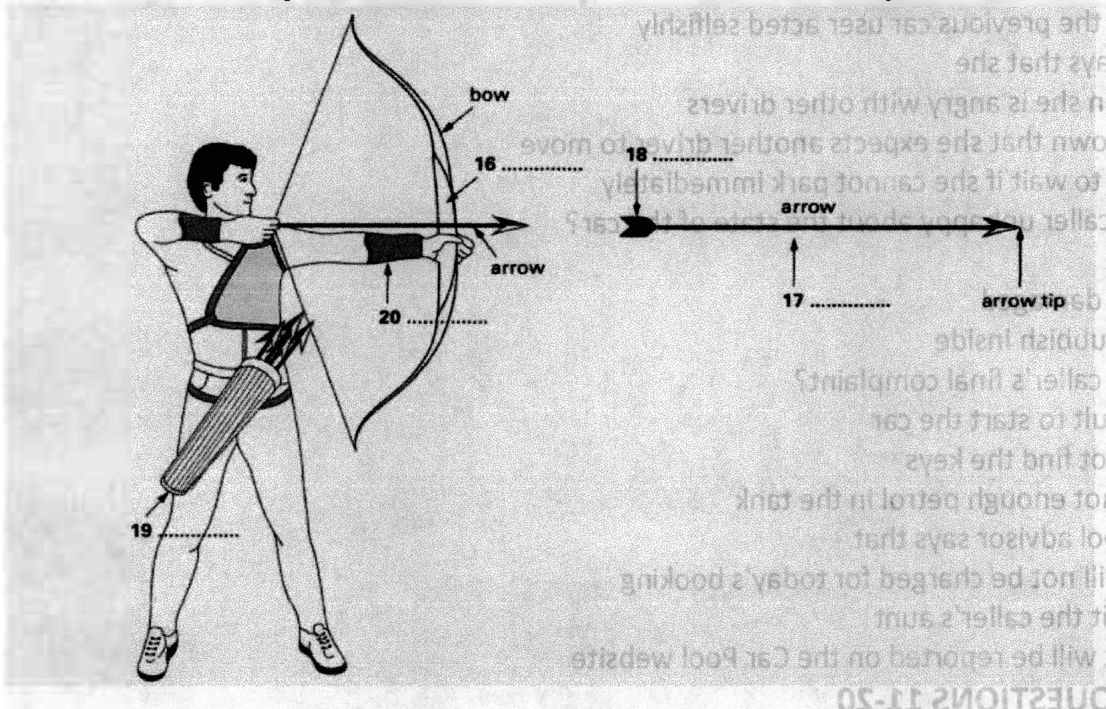

- A bracer
- B chest guard
- C drawstring
- D fibre glass
- E fletching
- F hand guard
- G quiver
- H shaft
- I sight
- J tension

SECTION 3 QUESTIONS 21-30

Questions 21-28

Complete the sentences below.

Use **NO MORE THAN TWO WORDS** for each answer.

21 Leo is worried about not being able to when he revises.

22 The tutor says that students need to make studying productive.

23 The tutor suggests that subjects or topics should be studied after something less demanding.

24 The tutor tells Leo to weigh up his And those he feels less confident about.

25 The tutor suggests that an in one or two exams might be preferable to only just passing a higher number of exams.

26 Leo wonders if he should realistically expect to some of his exams

27 The tutor says that applying a is essential when deciding what to revise.

28 Leo and the tutor agree that he prefers a style of learning.

Questions 29 and 30

Choose TWO letters, A-F.

Which of the following does the tutor believe to be true about revising with peers?

- A** Paying attention can become more difficult
- B** Study can be very well organized
- C** Students become too competitive
- D** Student can mark each other's work
- E** The right kind of criticism can be valuable
- F** It develops social skills

SECTION 4 QUESTIONS 31-40

Answer the questions below.

Write **NO MORE THAN TWO WORDS** for each answer.

31 Where was Sir Alfred Hitchcock from?

32 At what age did Hitchcock move to Hollywood?

33 What did the British movie *Blackmail* have that made it unique?

34 What was the title of Hitchcock's first failed attempt at making a movie?

Questions 35-40

Choose the correct letter A, B or C.

35 Why did Hitchcock want the camera to move in a particular way?

- A** It meant that scenes could be filmed more quickly
- B** It changed the way the viewer followed the action
- C** It was what viewers expected

36 What does the lecturer say about the filming of the shower scene in *Pyscho*?

- A** Hitchcock was wasting valuable time
- B** Today's filmgoers are not interested in such detail
- C** Spending a week filming one scene would now be too expensive

37 Which of the following statements about Hitchcock's movies is **NOT** true?

- A** The viewer is left to imagine many of the actual murders
- B** The real aim is to expose the characters' inner thoughts
- C** It is easy to guess the ending of a Hitchcock film



38 According to the lecturer, viewers of Psycho identify with the murderer because

- A the character they initially relate to is dead
- B he is a likeable character
- C the other characters are not very interesting

39 The lecturer believes that before Hitchcock

- A directors always acted in their own films
- B directors did not play such an important role in film-making
- C people knew what the director looked like

40 What is the main theme of the lecturer?

- A the movie Psycho
- B a comparison of various Hitchcock movies
- C Hitchcock's contribution to cinema

TEST 62

SECTION 1 Questions 1-10

Questions 1-2

Complete the notes below.

Write **NO MORE THAN ONE WORD** for each answer.

Advantages of mall walking:

- free exercise
- indoor activity – can avoid bad weather outside
- safe – no heavy 1 to worry about
- easy access to 2 and water

Questions 3-7

3 Anya found out about the mall walking programme

- A on the mall website
- B from a friend
- C on a notice board

4 Most mall walkers

- A walk before starting work or college
- B start their walk at 9 a.m.
- C walk every weekday

5 Mall walking groups meet at

- A the entrance to the mall
- B the food court
- C the information kiosk

6 The number of people who participate in each mall walk is usually

- A fewer than 10
- B between 10 and 15
- C around 50

7 Mall walks generally last

- A half an hour
- B one hour
- C one and a half hours

Questions 8-10

Complete the form below.

Mall Walking Programme Member Details

First name: Anya

Surname **8**

Address: **9** 2 Burlington Street

Contact telephone number: **10**

Occupation: Student

Start date: 4th February

SECTION 2 QUESTIONS 11-20

Questions 11-15

Answer the questions below.

Write **NO MORE THAN TWO WORDS OR A NUMBER** for each answer.

11 Who works in the Beehive building?

12 What nationality was the architect of the building?

13 In which year did construction of the building start?

14 How long did it take to construct?

15 How tall is the building in metres?

Questions 16 and 17

Which **TWO** facilities does the speaker mention?

16

17

Questions 18-20

What does the speaker say about the following features of the building?

Write the correct letter, A, B or C next to questions 18-20.

A bronze

B marble

C steel

D timber

18 The staircase railings are made of

19 The floor of the banquet hall is made of

20 The floor of the entrance foyer is made of

SECTION 3 QUESTIONS 21-30

Questions 21-24

Complete the summary below.

Write **NO MORE THAN ONE WORD AND/OR A NUMBER** for each answer.

Advantages of Speed Reading

Many people read at an average rate of **21**..... words per minute. This means an average page in a book or document takes up to **22** minutes to read. Speed reading means that you can double the rate to **23** words per minutes so you can read the content in half the time. Another important advantage of speed reading is that you can better comprehend the overall **24** of an argument.

Questions 25-30

Choose **THREE** letters A-G.

Which **THREE** things are discussed by the speaker?

25

26

27

- A ways to prepare for a speed reading test
- B making good use of the whole range of library services
- C using the internet as a resource to test your reading speed
- D what books and resources are available in the library
- E practical ways to improve reading speed
- F limitations of many speed-reading techniques
- G the comparison between speed reading and sport

Which **THREE** types of text are mentioned by the speakers?

28.....

29

30.....

- A articles
- B assignments
- C books
- D dissertations
- E journals
- F reports
- G theses

SECTION 4 QUESTIONS 31-40

Complete the notes below.

Use **NO MORE THAN TWO WORDS** for each answer.

Eco-tourism

Aims:

To encourage tourists to travel in a responsible way

To reduce the **31**..... of tourism (for example, rubbish, **32** and criminal activity)

Alternative Tourism

Is different from traditional holidays (for example, beach and sightseeing holidays)

Examples:

33 and adventure trips

Sustainable Tourism

Shares the same **34** as eco-tourism

Travel is not restricted to **35** (can include travel to urban areas too)

Involves adhering to local **36** (for example, dress and language)

Voluntourism

Combines volunteering with tourism

Involves assisting with building work in local communities and participating in **37**



Examples

Tree planning in Costa Rica
 Assistance with sustainable **38** in Cuba
 Cleaning up local **39** in Jamaica
 Animal conservation in **40**..... and Ecuador

TEST 63

SECTION 1 Questions 1-10

Questions 1-4

Complete the notes below.

Write **NO MORE THAN TWO WORDS AND/OR A NUMBER** for each answer.

NOTES ON COURSES AVAILABLE

Example:

Number of language courses per week: **10**

Languages

- Modern European Languages: French, Spanish, German, Dutch, Polish
- Ancient Languages: Latin and **1**
- Asian Languages: Hindi and **2**

Cost £25.00 per person per term

Notes: Bulk booking (more than two courses for **3**..... terms) 10% discount.

To reserve a place in a language class, telephone Mrs Johnson on extension **4**

Question 5-10

Complete the table and information below.

Write **NO MORE THAN TWO WORDS AND/OR A NUMBER** for each answer.

Monthly Computer Courses

Date	Subject	Places Available Person	Cost per
1st February	5	24	£40.00
March	Excel	6only	£45.00
April	Outlook	19	7
3rd 8	Word	9	£55.00

To book a place on a computer course, call Mary Jones before **10**

SECTION 2 QUESTIONS 11-20

Questions 11-16

Complete the summary of the welcoming speech.

Write **NO MORE THAN TWO WORDS AND/OR A NUMBER** for each answer.

Dear Joe,

You missed the Welcome meeting. We were greeted by the principal of Donleavy

11....., who explained how the university has **12** campuses.

He told us where all the important buildings on this campus are and also explained

Which subjects are studied on the other two. The principal's **13**..... is on our



Campus. Weekly 14..... are held in the Office and Administration Block every Tuesday at 1:30 p.m., and we are encouraged to attend. The university shop sells all the 15..... and stationery we might need, and you can find it next to the cafeteria. Remember, we must carry our 16..... to get into the campus.

Regards,
Rebecca

Questions 17-20

Complete the labels on the buildings in the map.

Write **NO MORE THAN TWO WORDS AND/OR A NUMBER** for each answer.

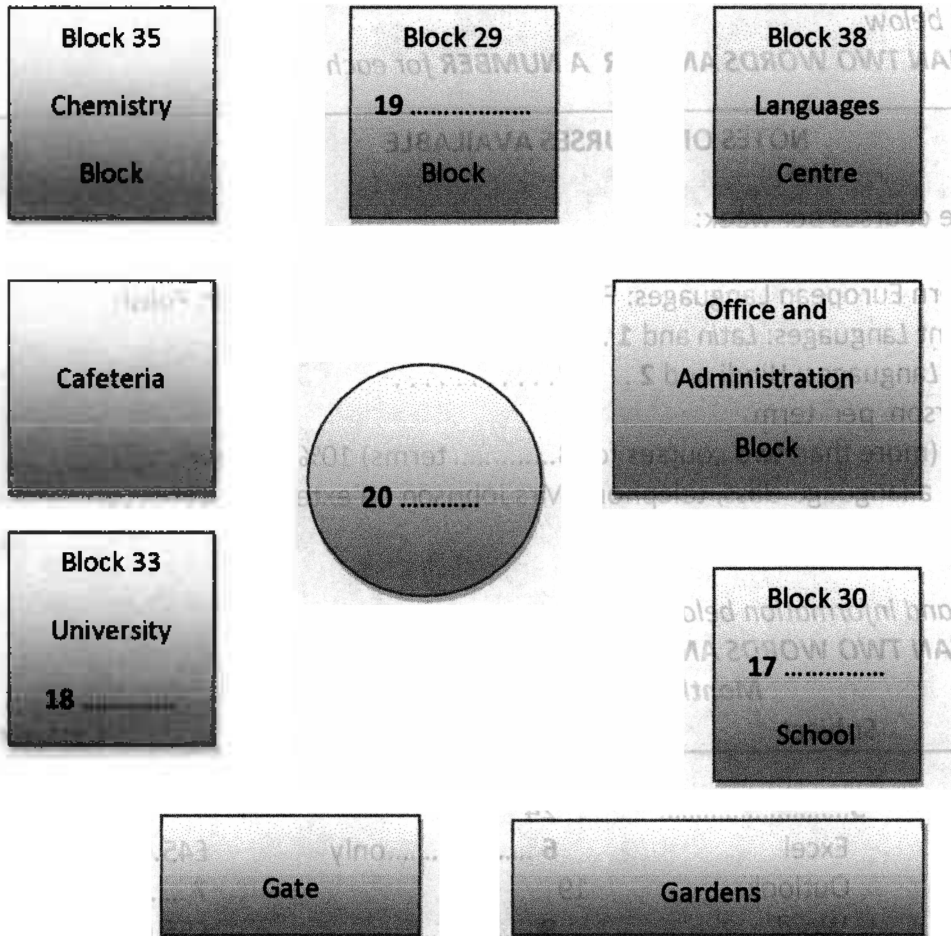

SECTION 3 Questions 21-30

Choose the correct letter, A, B or C.

21 Bill was ill. What was wrong?

- A A cold
- B A food allergy
- C A severe pain in his head

22 Bill and Sarah

- A live near each other.
- B have never worked on a project together.



- C have plans for later that evening.
- 23 Bill and Sarah have to
- A research and write a survey questionnaire.
 - B ask shopkeepers questions.
 - C submit their project via the Internet.
- 24 What does Sarah want Bill to do?
- A Visit the library
 - B Write a list of questions
 - C Use a computer
- 25 Which of the following items will be included in Bill and Sarah's research?
- A Deodorants and cosmetics
 - B Electrical goods
 - C Food and clothing
- 26 With what aspect of the project does Bill express concern?
- A Meeting the project's timeline
 - B Invading people's privacy
 - C Finding enough reference material
- 27 What does Bill plan to do for the rest of the day?
- A Review the notes from the previous week
 - B Prepare for his next meeting with Sarah
 - C Find people to participate in the research
- 28 What does Sarah do for Bill?
- A Lets him borrow her book
 - B Gives him a copy of her notes
 - C Promises to help him study
- 29 What does Sarah have to do at the library?
- A Research
 - B Meet Bill
 - C Collect some books
- 30 Where do Bill and Sarah agree to meet the next day?
- A In the library
 - B In class
 - C In the laboratory

SECTION 4 QUESTIONS 31-40

Questions 31-32

Choose the correct letter, A, B or C.

- 31 Who is giving this talk?
- A An artist
 - B An art critic
 - C A curator
- 32 Why did the speaker choose to speak about Joan Miró?
- A Because a new work by Miró was recently added the gallery
 - B Because he thought Miró would appeal to people with different tastes
 - C Because he felt everyone would be familiar with Joan Miró's art



Questions 33-35

Which **THREE** features below are mentioned by the speaker as characteristic of Joan Miró's art?
Choose **THREE** letters: A-G.

- A Themes from Spanish history
- B The use of primary colours
- C Influence of surrealism
- D Complex geometric forms
- E Large paintings
- F Equal number of sculptures and paintings
- G Birds and trees

Questions 36-40

Complete this table with information from the listening.

Write **NO MORE THAN TWO WORDS AD/OR A NUMBER** for each answer.

THREE OF MIRÓ'S GREAT WORKS

TITLE	DATE	LOCATION	DEATILS
Woman and 36	1982	A 37 in Barcelona	Tall sculpture, covered in 38
Woman	39	National Gallery of Art, Washington, D.C.	Large canvas, bright colours
Seated Woman II	1939	Guggenheim Museum, New York	Painted when Miró was influenced by the 40..... in Spain

TEST 64

SECTION 1 Questions 1-10

Questions 1-3

Complete the form below

Write **ONE WORD OR A NUMBER** for each answer.

University Accommodation Dept.

Customer Information

Example :

The caller wants accommodation for international students.

Student Name: Maria Teresa 1 Villa



Student Number: 2
 Faculty: Modern 3.....
 Starting: September 1

Questions 4-7

Complete the table below.

Write **ONE WORD AND/OR A NUMBER** for each answer.

Name of Block	Location	Rent
The Trigon	Located near 4 and main campus	£ 5 per week
The Cube	Located near 6 entrance to campus	7 room options -1 bedroom =£180 per week -2 bedrooms=£110 per week per person

Questions 8-10

Choose **THREE** letters, **A-E**.

Which **THREE** of the following are features of accommodation at *The Cube*?

- A parking garage
- B laundry room
- C ensuite bathroom
- D kitchen
- E study bedroom

SECTION 2 QUESTIONS 11-20

Questions 11-16

Complete the notes below.

Write **NO MORE THAN TWO WORDS AND/OR A NUMBER** for each answer.

Barker's Country Safaris

Established: 11 years ago by John and Nancy Barker.

As teens the Barkers enjoyed:

- climbing
- kayaking
- white-water rafting
- pot-holing

12

At university they organized:

- Motor trips
- 13 tours

5 years ago they 14 their regular jobs

15 years later they began running activity tours

1 year ago they started activities for 16 groups



Questions 17-20

Complete the table below.

Write **NO MORE THAN THREE WORDS AND/OR A NUMBER** for each answer.

Tour options

Name	Size	Times
Woodland tour and trail	10 jeeps 17 people per jeep	Morning: 8 AM Afternoon: 18 PM to 6PM Evening: 7-11 PM
Family 19	1 jeep/jeeps if 20 party	Whole Day From 10 AM till 11 PM

SECTION 3 QUESTIONS 21-30

Questions 21-27

Choose the correct answer, A, B or C.

- 21** Jess wants to start the meeting by
- A organizing his notes
 - B taking a photo
 - C reviewing the objectives for the project
- 22** What are Matt and Jess planning to study?
- A different species of insects
 - B different species of plants
 - C old photos
- 23** How far apart are the plots supposed to be?
- A 12 feet apart
 - D 10 meters apart
 - C 10 miles apart
- 24** Where can the bamboo sticks be purchased?
- A department stores
 - B toy shops
 - C gardening centres
- 25** One person throws the frame and the other person
- A turns on the spot
 - B smiles and waves
 - C marks out the squares
- 26** The instructions sound complicated because
- A they are in writing
 - B there is so much turning around
 - C there are so many squares
- 27** Jess thinks Matt should do the throwing because
- A he has more experience
 - B he has a stronger arm



C he is more accurate

Questions 28-30

What do Matt and Jess decide about each of the possible locations?

Write the correct letter, A, B or C.

- A they will go there
- B they might go there
- C they will not go there

Locations

- 28 the lowland around the marsh _____
- 29 behind the beach _____
- 30 behind the headland near the bay _____

SECTION 4 QUESTIONS 31-40

Questions 31-34

Choose the correct answer, A, B or C.

- 31 Compared to other industries, tourism has
 - A the most young customers.
 - B the biggest impact on people.
 - C only indirect impact.
- 32 In global tourism there is a
 - A 97% economic leakage .
 - B a 9 in 10 chance of failure.
 - C about 9% economic failure.
- 33 Some countries with high levels of tourism still have
 - A poor accommodation.
 - B great poverty.
 - C large national debt.
- 34 Geo-tourism is all about
 - A reducing pollution from industry.
 - B increasing numbers of travelers.
 - C providing a fair reward for service.

Questions 35-40

Complete the notes below.

*Write **ONE WORD AND/OR A NUMBER ONLY** for each answer.*

Project with World Bank

Developing technology platform
brings grassroots products to locals
avoids 35men

Volunteering

many teens schedule 36-year between school and university
volunteering organizations charge up to £ 37

Geo-tourism

customers are looking for organizations that can suggest 38 projects
organizers would charge flat 39
this would make for a good 40 for each customer



TEST 65

SECTION 1 Questions 1-10

Questions 1-6

Complete the form below, using **NO MORE THAN TWO WORDS AND/OR A NUMBER** for each answer.

EXPENSES CLAIM INFORMATION-GB AIRLINES	
Customer name: Mr	1
Date of Departure: 2	2016
Flight Number : GB1011	
Flight: From 3	to London Heathrow, UK
Departure Time: 4 p.m.	
Expenses Claimed: 5	Hotel, 73 euros
Taxis, 6	

Questions 7-10

Complete the sentences below with **NO MORE THAN TWO WORDS AND/OR A NUMBER**.

- 7 The customer had the option for his previous flight.
- 8 There are three meal options without meat: vegetarian, vegan, and
- 9 The vegan option doesn't contain any, eggs, fowl, or honey.
- 10 The meal option for the customer's flight to Kiev must be changed before the departure time.

SECTION 2 QUESTIONS 11-20

Questions 11-14

You are going to hear with a self-publishing expert.

What **FOUR** things does she say new writers need to make sure they have before they self-publish?

- A an impeccable edited novel
- B another finished novel
- C a budget
- D a solid marketing plan
- E a new novel in progress
- F a lot of money on the side
- G a good understanding of grammar

Questions 15-17

Choose the correct letter, A, B or C.

- 15 Patricia Abaddon's first novel
- A was a commercial success.



- B had mediocre sales.
 - C performed terribly.
- 16 For the first year after his novel's publication, Patricia Abaddon
- A avoided checking how many copies he sold.
 - B was depressed about the results.
 - C was relatively happy with how the novel was doing.
- 17 Patricia Abaddon subscribed to writing magazines because
- A she wanted to find out about writing competitions.
 - B it was a good way to build a fan base.
 - C she wanted to read advice from professionals.

Questions 18-20

Complete the sentences below with **NO MORE THAN THREE WORDS**.

- 18 Patricia Abaddon published her second novel under a because she didn't want her readers to know about her first novel.
- 19 Patricia Abaddon used her website and her pages on to promote her second novel.
- 20 By the time her second novel was out, Patricia Abaddon wanted her third novel to be

SECTION 3 QUESTIONS 21-30

21 Which graph shows what students reported feeling after a year at school?

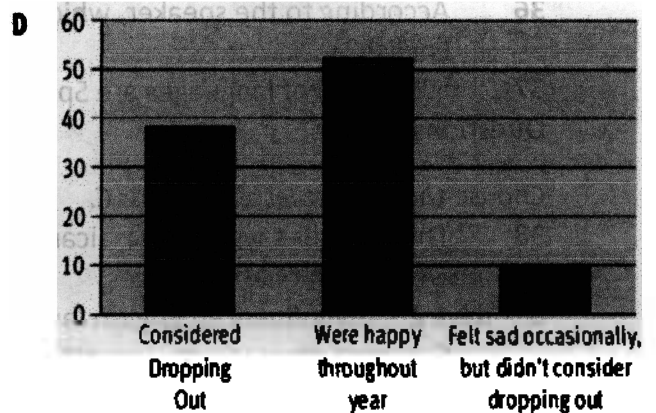
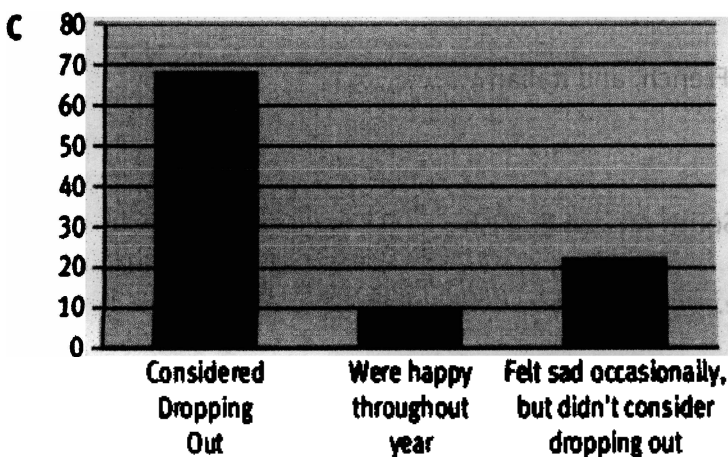
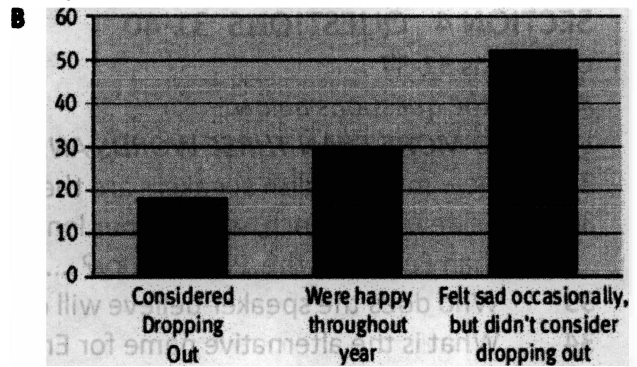
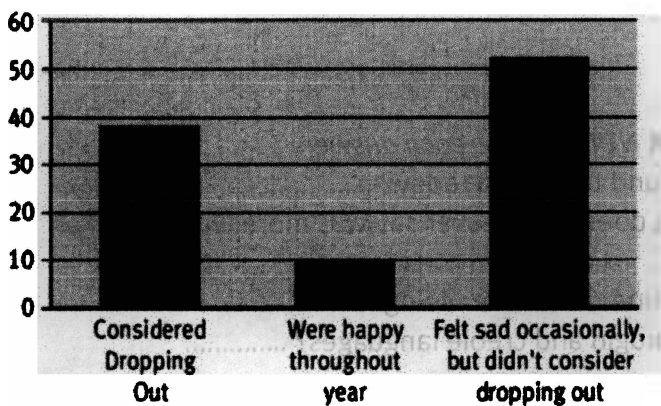

Questions 22-25

Which student will present which information?

- A Gale
- B Lindsay
- C Kevin

- 22 the research focus
- 23 the focus group of the research
- 24 how the students acquired access to the focus group
- 25 the structure of the survey used in the research

Questions 26-30

Complete the sentences below. Write **NO MORE THAN TWO WORDS AND/OR A NUMBER** for each answer.

- 26 The number of males and females participating in the study was
- 27 per cent of the participants came from Europe.
- 28 The vast majority of the participants were 20 or 21 years old, and only per cent were 19.
- 29 Most participants reported missing home and/or suffering from at the start of their course.
- 30 The students examined the of the previous two years to ensure the numbers in their research were as accurate as possible.

SECTION 4 QUESTIONS 31-40

Questions 31-37

Answer the questions below.

Write **NO MORE THAN THREE WORDS AND/OR A NUMBER** for each answer.

- 31 How many English speakers are there around the world today?
- 32 Aside from French, which other languages does the speaker say was more widely spoken than English in the 19th century?
- 33 Who does the speaker believe will determine the future of English?
- 34 What is the alternative name for English pidgin and creole languages?
- 35 What does "longi" mean?
- 36 According to the speaker, which languages has a history which is very similar to English?
- 37 What kind of languages are Spanish, French, and Italian?

Questions 38-40

Choose the correct letter, A, B or C.

- 38 The speaker says that Jamaican and South African English
 - A are very traditional languages.
 - B have greatly influenced English language.
 - C were created very recently.
- 39 According to the second theory mentioned by the speaker, English
 - A might lose some of its more complex features in a global level.
 - B might become even more complicated than it is now.
 - C might be called 'Globbish'.

- 40 English is a unique language because
- A it has the largest number of speakers in the world.
 - B it hasn't changed much throughout human history.
 - C it's spoken by a larger number of non-natives than any other language.

TEST 66

SECTION 1 Questions 1-10

Questions 1-6

Complete the form below, using **NO MORE THAN TWO WORDS AND/OR A NUMBER** for each answer.

PET PROTECT UK	
<u>PET DETAILS</u>	
Type of pet:	
<input checked="" type="checkbox"/> dog	<input type="checkbox"/> cat <input type="checkbox"/> rabbit
Pet's name: 1	
Pet's D.O.B.: 2, 2013	
<u>For Dogs Only</u>	
Is the dog a guide dog?No.....	
Has the dog been neutered? 3	
Type of dog: 4	
<u>CUSTOMER DETAILS</u>	
Name: Peter 5	
Address: 27 Cherry Drive, NW8 2HD	
Phone Number: 6	

Questions 7-10

Complete the table below, using **NO MORE THAN ONE WORD OR A NUMBER** for each answer.

Type of insurance	Fees
Basic	£8 p.c.m.
Premium	7 £ p.c.m. for first 6 months, then up to £18*
Ultimate Premium	£15 p.c.m. for first 6 months, then up to £20

*(if expenses claimed do not exceed £300 the fee drops to £ 8)

Please be advised that your pet's documents and 9 must be checked before we proceed with an insurance agreement. All three insurance plans cover 10 fees.

SECTION 2 QUESTIONS 11-20

Questions 11-14

You are going to hear an induction given to a group of students at a summer school.

Complete the sentences below.

Write **NO MORE THAN THREE WORDS** for each answer.

- 11 Jasmine Climb founded her school on a quiet and isolated site because she appreciated the of such places.
- 12 When the school was first founded, it had neither trees nor a
- 13 The students listening to the speech will be staying at the school for
- 14 The programme for the students' first day will culminate with a

Questions 15-20

Complete the plan below using **NO MORE THAN TWO WORDS** for each answer.

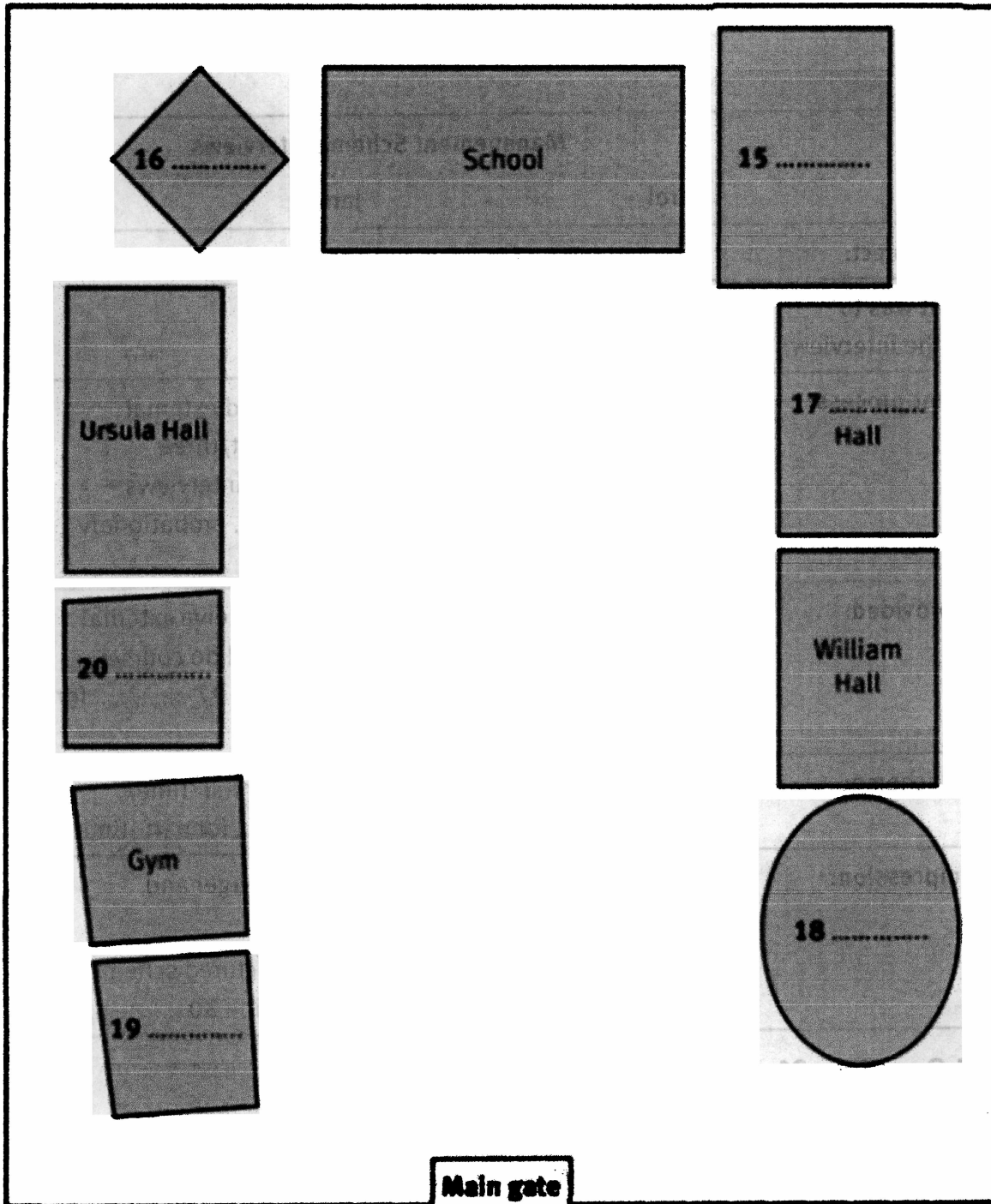

SECTION 3 QUESTIONS 21-30

Questions 21-30

Complete the table below.

Write NO MORE THAN THREE WORDS AND/OR A NUMBER for each answer.

SECTION 4 QU

	Management Scheme Interviews	
	Carol	James
Interview Subject:	Manager from 21	Manager from 22
How easy it was to schedule the interview:	Manager had a 23 – rescheduled 3 times	No issues
Recruitment process:	24 process: panel interview and trial day – 3 months probationary period	Internal and external recruitment/three individual interviews – 25 probationary period
Training provided:	Trainees learn 26 and move up the ladder, starting at the bottom	Trainees receive external training and do courses – also sent to 27 for a semester
Length of scheme:	3 years	2 years for full-time/ 28 for part-time
Overall impression:	Manager friendly and knowledgeable Scheme very helpful, but not enough 29	Manager eager and friendly Well-structured scheme, but duration 30

SECTION 4 Questions 31-40

Questions 31-33

Complete the sentences below.

Use **NO MORE THAN TWO WORDS AND/OR A NUMBER** for each answer.

31 There are few about being a foreign correspondent, but they are the wrong reason to choose it as a career.

32 The dangers of being a foreign correspondent lead to the death of per year.

33 Every journalist needs to possess certain media skills and

Questions 34-37

What **FOUR** pieces of advice does the speaker give to aspiring foreign correspondents?

- A to assimilate their target country's culture
- B to get work experience around the world
- C to travel as much as possible
- D to examine the past of their target country

- E** to learn how to speak impeccable English
- F** to create impressive CV before they leave their home country
- G** to study other languages

Questions 38-40

Choose the correct letter, A, B or C.

- 38** Because of recent technological advancements
- A** international journalism is less becoming common.
 - B** newspapers are loath to hire journalists on a contract.
 - C** newspapers have started to opt for independent foreign correspondents.
- 39** If foreign correspondents want to earn enough money
- A** they need to learn how to network.
 - B** they need to have a second job.
 - C** they need to start at the bottom.
- 40** The speaker's ex-student found which of the following pieces of advice very useful?
- A** "You need to remember to renew your passport."
 - B** "You need to learn how to deal with failure."
 - C** "You need to remember that failure is inevitable."

TEST 67

SECTION 1 Questions 1-10

*Complete the form below, using **NO MORE THAN TWO WORDS AND/OR A NUMBER** for each answer.*

The George and Dragon BOOKING FORM	
<u>DETAILS</u>	
Name: Carla 1	
Phone Number: 2	
Type of event: retirement party	
Date: 3	
Number of people: 16-17 (<i>Please note that the upstairs room has a capacity of no more than</i> 4 people)	
<u>MENU</u>	
Seven 5	
Two ham and cheese and two 6	
7 platters	
One Caesar and one 8 salad	
<u>PRICE</u>	
<i>Venue will be needed for a total of</i> 9hours	
Final price: 10 £.....	



SECTION 2 QUESTIONS 11-20

Questions 11-15

Complete the sentence below.

Write **NO MORE THAN TWO WORDS AND/OR A NUMBER** for each answer.

- 11 Antonia Watson's parents instituted the Antonia Watson Memorial Poetry Award in
- 12 The Antonia Watson Memorial Poetry Award's second prize is £
- 13 Thomas is one of Antonia Watson's
- 14 The name of the first poem Antonia Watson published was
- 15 After her grandfather passed away, Antonia suffered from

Questions 16-18

Choose the correct letter, A, B or C.

- 16 Between 1999 and 2003, Antonia
A wrote a few theatre plays and painted self-portraits.
B published several poems in her college's journal.
C remained ardent about poetry despite her break from writing.
- 17 The speaker and Antonia met in Sheffield, where
A they both studied English Literature at the University of Sheffield.
B they shared a room in a centrally located flat for a year.
C they became friends with each other despite having no common friends.
- 18 Antonia's self-published poem collection
A was named after a poem about her birthday.
B was released a few months before her death in 2005.
C led to her signing a contract with a literary agent.

Questions 19-20

Complete the summary below.

Write **NO MORE THAN TWO WORDS AND/OR A NUMBER** for each answer.

The Antonia Watson Memorial Award has dealt with a variety of themes over the years, all falling under the scope of a general theme reflecting Antonia's personal belief that all humans are **19** Next year's competition is no exception, with its theme of **20**

SECTION 3 QUESTIONS 21-30

Questions 21-24

Label the chart below.

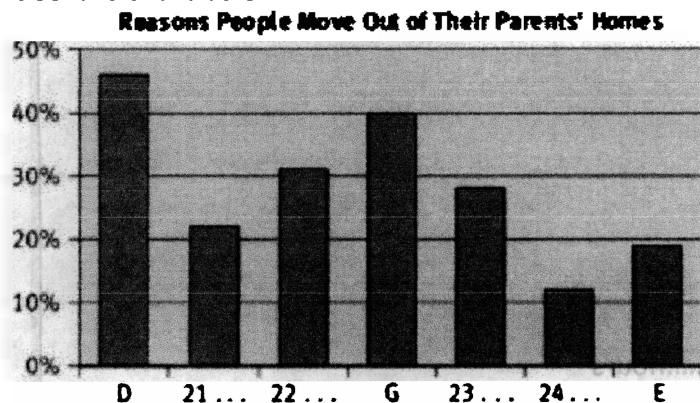

- A** relationship
- B** emancipation
- C** need for freedom
- D** studies
- E** conflict with paren
- F** pressure from pare
- G** new job
- H** need for space and privacy
- I** abuse



Questions 25-29

Which student will present which information?

- A Melaine
- B Chris
- C Both

Write the correct letter, A, B or C.

- 25 the 18-20 group
- 26 the 20-24 group
- 27 the under-18 group
- 28 the 25 and over group
- 29 the group that still live with parents

Question 30

Which graphs shows what problems people who moved out of their parents' house faced in their first few months living alone?

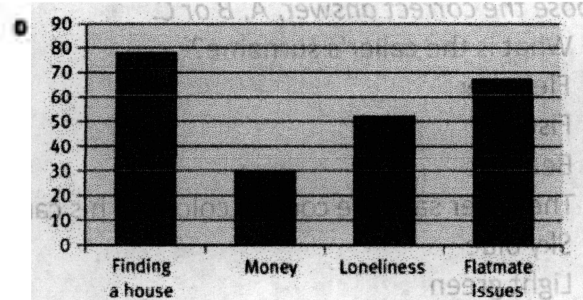
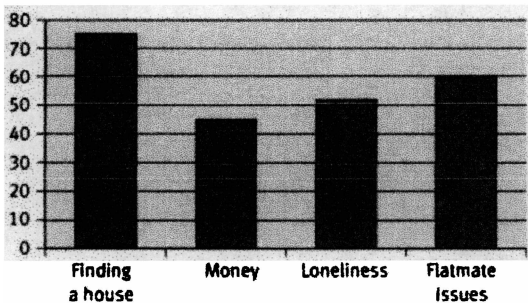
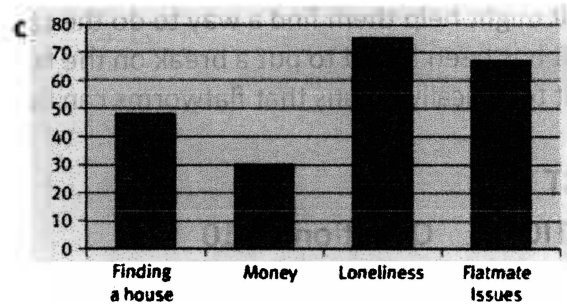
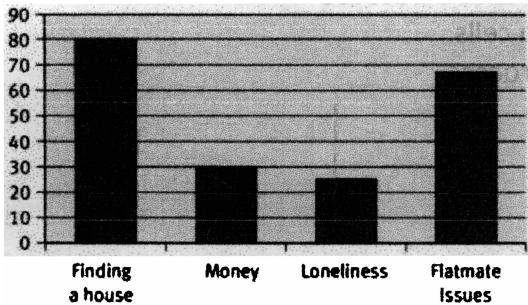

SECTION 4 QUESTIONS 31-40

Questions 31-33

What are the **THREE WAYS** in which turbellaria differ from other flatworms, according to Dr Baker?

- A they are not parasitic
- B 80% of their nutrition comes from platyhelminths
- C they have a simpler structure
- D they're less intelligent
- E they have eyes
- F their sensory system is more elaborate
- G their sensory organs are chemical

Questions 34-38

Complete the sentences below.

Write **NO MORE THAN THREE WORDS AND/OR A NUMBER** for each answer.

- 34 Turbellaria are able to thanks to the structure of their bodies.
- 35 Any part of a turbellarian's body that isn't occupied by organs is filled with a
- 36 While turbellaria are hermaphrodites, they don't
- 37 Most turbellaria's natural habitat is
- 38 Turbellaria expel all undigested food from their

Questions 39-40

Choose the correct letter, A, B or C.

- 39 Fission is the ability of
 - A two worms to grow out of one if you split it in the middle.
 - B flatworms to procreate by breaking into smaller flatworms.
 - C flatworms to regenerate organs they've lost.
- 40 Fission in flatworms is an important phenomenon for scientists because
 - A it might help them find a way to do the same to human cells.
 - B it has been found to put a break on the human aging process.
 - C it technically means that flatworms can live forever.

TEST 68

SECTION 1 Questions 1-10

Questions 1-5

Choose the correct answer, A, B or C.

- 1 What is the caller's surname?
 - A Fleischer
 - B Fischer
 - C Bennett
- 2 The caller says the correct colour of his car is
 - A Sky blue
 - B Light green
 - C White
- 3 What time does the caller say he went to collect his car?
 - A 9:30pm
 - B 8pm
 - C 8:30pm
- 4 Where does the caller usually store the front panel of his radio?
 - A In his pocket
 - B The hospital
 - C In the glove compartment
- 5 What does the advisor say she will send through the email to the caller?
 - A A radio
 - B Some CDs
 - C Some forms



Questions 6-10

Complete the notes below.

Write **NO MORE THAN TWO WORDS AND/OR A NUMBER** for each answer.

Insurance Claim Report

CUSTOMER FIRST NAME : Bennett
 POLICY NUMBER: 6
 TYPE OF CLAIM: Stolen 7
 PLACE WHERE OFFENCE WAS REPORTED: York 8Station
 CUSTOMER AWARE OF THE DANGER: No
 OTHER ITEMS STOLEN: Car radio, CDs and an old 9
 DOCUMENT REQUESTED TO SUPPORT CLAIM: Police report and 10

SECTION 2 QUESTIONS 11-20

Questions 11-13

Complete the sentences below.

Write **ONE WORD ONLY** for each answer.

- 11 There are two entrance to the
- 12 The first section you enter when leaving the staffroom is the
- 13 The pass through the dungeons as a group.

Questions 14-18

Complete the labels on the map.

Write **NO MORE THAN TWO WORDS** for each answer.

Stevensbridge Dungeons – Floor Plan

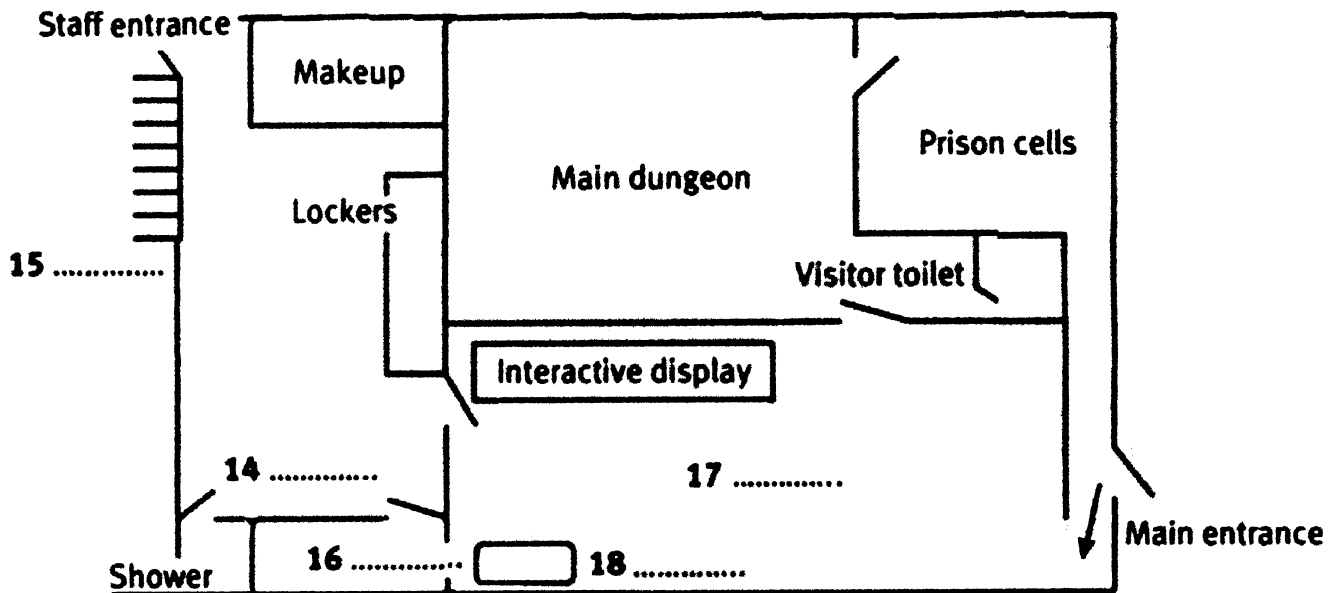

Questions 19-20

Choose **TWO** letters, A-E.

What are **TWO** things the speaker suggests the employees should do to help visitors?

- A help to carry their bags
- B guide them if they have gone the wrong way
- C talk to them in a strange accent
- D scare them so they have a more authentic experience
- E answer any questions they might have

SECTION 3 QUESTIONS 21-30

Questions 21-24

Which **FOUR** features below are mentioned by the woman as characteristic of pu-erh tea?

Choose **FOUR** letters: A-H.

- A Pu-erh is a dark tea
- B The tea leaves are picked and sorted by machines
- C It comes from a region of southern China called Yunnan
- D It undergoes a period of aging in the open air
- E It is a white tea
- F Pu-erh tea is expensive
- G The taste is very bitter
- H The tea is sold in tea bags

Questions 25-26

Choose the correct answer: A, B or C.

25 What is the likely job of the man?

- A A journalist
- B A tea farmer
- C An artist

26 Why does the woman dislike teabags?

- A She is allergic to them
- B The smell strange
- C Because the tea is trapped and cannot move freely

Questions 27-30

Complete the sentences below.

Write **ONE WORD** for each answer.

- 27 Tea must be brewed in theway to fully experience it.
- 28 The effect of on the taste of pu-erh is similar to that of wine.
- 29 Pu-erh tea leaves are gathered into big piles by the
- 30 Tea meditation involves focusing on two things:and body.

SECTION 4 QUESTIONS 31-40

Questions 31-36

Complete the flow-chart below.

Write **NO MORE THAN ONE WORD AND/OR A NUMBER** for each answer.

William the Conqueror defeated the **31** army in 1066.

The words beef, hour, fruit and **32** all entered the English language from French.

Gothic **33** architecture also arrived in England from France.

Construction of Wells Cathedral started in **34**

It was **35** in 1490.

Wells Cathedral is one of twenty-six cathedrals in England. This **36** is called the medieval cathedrals of England.

Questions 37-40

Complete the table below.

Write **NO MORE THAN TWO WORDS AND/OR A NUMBER** for each answer.

Architectural information		Design Notes
Cathedral name	Wells	The cathedral's lancet windows have no tracery.
Style	37	
Construction began	1175	West front of the cathedral is celebrated for its life-sized 39
Construction completed	1490	
Nave height	20 metres	In the past the sculptures and decorative carvings would have been 40 and gilded.
Length	38	

TEST 69

SECTION 1 Questions 1-10

Questions 1-5

Complete the details in the form below.

Write **NO MORE THAN ONE WORD AND/OR A NUMBER** for each answer.

z-Mobile Services	
Incident Report Sheet	
<i>Example</i>	<i>Answer</i>
Postcode	CN21EB
Mobile phone number	1 07890 570
Name	2 Green
Crime Reference Number	3 CZ5
4 Mobile Equipment Identity (IMEI) number	Not known
Time, date of theft	5 1-2pm, 16.....

6 The caller's phone was stolen

A when he went to the toilet

B from the table

C from his pocket

7 The caller will have to pay a charge

A for a new phone

B if his phone is stolen again

C in 12 months' time

8 The delivery address is

A 34 Solent Gardens

B 34 Solent House

C 34 Solent Grove

9 The caller's IMEI number

A can be found on the side of the phone battery

B is made up of 15 digits

C cannot be found

10 The operator

A transfers the caller to a colleague

B will ring the caller back the next day

C asks the caller to ring back

SECTION 2 QUESTIONS 11-20

Questions 11-13

Choose **THREE** letters, A-G.

Which **THREE** things did the presenter say he enjoyed about his holiday?

- A the food
- B the weather
- C the nightlife
- D the journey
- E the people he met
- F His children had a good time

Questions 14-16

Write **NO MORE THAN THREE WORDS** for each answer.

Which **THREE** radio shows does the presenter recommend Sally listen to?

- 14
- 15
- 16

Questions 17-18

Choose the correct letter, A, B or C.

17 What does John object to?

- A the time of day the programmers are on
- B the lack of time guests have to answer questions
- C the interviewers' questions

18 How does John think the problem could be solved?

- A have further live radio shows
- B put the radio shows on at different times
- C extend the show on the Internet

Questions 19-20

Choose **TWO** letters, A-E.

Which **TWO** things does Clive want to hear more of on the radio station?

- A younger guests
- B music for older people
- C consumer issues for older people
- D older presenters
- E health problems faced by older people

SECTION 3 QUESTIONS 21-30

Questions 21-25

Complete the notes below.

Write **NO MORE THAN THREE WORDS** for each answer.

Presentation Information

- Day **21**
- Subject **22**
- Length **23**
- Technical equipment needed **24**
- Location **25**



Questions 26-30

Which person is responsible for the following tasks?

Write the correct letter, A, B or C, next to questions 26-30.

NB You may use any letter more than once.

- A Simon
- B Kelly
- C Fiona

- 26 introduce and end the talk
- 27 talk about the historical perspective
- 28 talk about the contemporary situation
- 29 book the technical equipment
- 30 build the presentation

SECTION 4 QUESTIONS 31-40

Questions 31-37

Choose the correct letter, A, B or C.

31 The speaker thinks

- A a university is a similar experience to school or college
- B students need more tutor support at university
- C a lot of students have difficulties at university

32 Which chart, A, B or C, shows the degree of poor time management skills amongst male and female students?

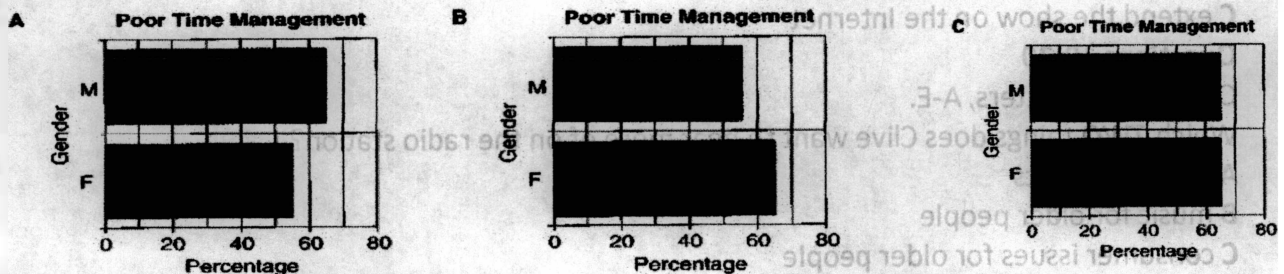

33 The speaker thinks it's important that

- A the academic planner is kept safe somewhere
- B the academic planner is put somewhere it can be seen easily
- C students remember to collect their academic planner

34 When filling in the academic planner students should

- A ignore non-academic occasions
- B try to keep visits home to a minimum
- C add all important academic and non-academic dates

35 Initially, the academic planner will

- A give the wrong impression about the amount of work there is
- B show some days are busier than others
- C give a clear idea of busy periods

36 According to the tutor, students should organize their studies



- A so that they have time for coffee breaks
- B so that they don't miss any seminars or lectures
- C as if it were a normal working day

37 The tutor makes the point that

- A cookery students do well when writing essays
- B cooking and essay writing share certain characteristics
- C cooking is a complicated process

Questions 38-40

Choose **THREE** letters, A-G.

Which **THREE** things does the tutor recommend?

- A when planning self-study, note the time you should spend studying
- B break tasks down into individual stages
- C avoid working in the evenings
- D put time aside for favorite TV programmes
- E do household tasks at regular times
- F avoid the library if your friends are there

TEST 70

SECTION 1 Questions 1-10

Questions 1-3

Choose the correct letter, A, B or C.

Example

Seb's course looks like it will be

A too difficult

B too easy

C enjoyable

1 Some of Lydia's classmates

A are going into town later.

B have already been into town.

C haven't got time to go out.

2 Seb says he

A is cooking a meal for his lost family.

B doesn't think he'll want to eat in town.

C has already eaten.

3 Lydia's teacher

A has asked her to do some shopping.

B advised her not to stay out late.

C told her the shops stay open longer that evening.

Questions 4-7

Complete the notes below.

Write **NO MORE THAN THREE WORDS AND/OR A NUMBER** for each answer.



YOUR HOST FAMILY DETAILS

Your host family are Mr and Mrs Andrews.

Address 4 Mayweather Road, Coldfield

Bus service 5 Number

Local landmarks 6 The house is opposite the

Telephone number 7 01764

Question 8

Choose the correct letter, A, B or C.

8 Lyida needs to find

A a stationer`s.

B a grocer`s.

C a chemist`s.

Questions 9-10

Complete the sentences below.

Write **NO MORE THAN THREE WORDS** for each answer.

9 Seb is looking for a _____.

10 They both have a voucher for the _____ in the city library.

SECTION 2 QUESTIONS 11-20

Questions 11-16

11 The self-access centre

A is always available.

B is generally quiet.

C gets busy during exams.

12 The internet PCs

A should be used for no more than half an hour.

B must not be used to access Facebook.

C are generally used to study English.

13 Usernames and passwords

A are created by the teachers.

B are issued during induction.

C are created by students.

14 The help desk

A is staffed by technicians.

B offers language support.

C is only open when two members of staff are available.

15 Photocopying of reference books

A is not allowed.

B is done by teachers.

C has a small cost.

16 The high-spec PCs

A can be used to browse the Internet.

B are available for word processing.



C may need a CD-ROM.

Questions 17-20

Complete the sentences below

Write **NO MORE THAN THREE WORDS AND/OR A NUMBER** for each answer.

17 Students can purchase a _____ from the help desk.

18 The graded readers can be borrowed for a maximum of _____

19 The centre opens at 8.30 and closes at _____, Monday to Friday.

20 On occasion the room is _____ by a teacher and might not be available.

SECTION 3 QUESTIONS 21-30

Questions 21-24

Choose the correct letter, A, B or C.

21 Jacob says that

A he needs to do more research.

B he read widely before writing the draft.

C he isn't confident about his main points.

22 The tutor thinks Jacob

A has presented both sides of the argument well.

B needs to do more work on the content.

C has organized the essays very well.

23 The ideas Jacob expresses in the essay

A should be re-ordered.

B are poorly presented.

C don't make sense.

24 The tutor suggests that Jacob

A look at the use of paragraphs in other pieces of writing.

B read one or two textbooks on writing skills.

C read widely to develop his vocabulary.

Questions 25-27

Complete the tutor's notes below.

Write **NO MORE THAN THREE WORDS** for each answer.

Very natural use of **25** _____ . Well done!

Try using higher level **26** _____ in your essays.

The sentences are sometimes too **27** _____.

Questions 28-30

Choose **THREE** letters, A-F.

What does the tutor suggest?

A Try some worksheets to practice formal writing.

B Check spelling carefully.

C Use more advanced vocabulary.

D Buy a thesaurus.

E Use some of the synonyms the tutor has suggested.

F Find alternative words to those that are underlined.



SECTION 4 QUESTIONS 31-40

Questions 31-34

Choose the correct letter, A, B or C.

31 Work experience is required

- A to get a professional job.
- B to do a postgraduate degree.
- C to join an undergraduate course.

32 Graduates on placements

- A develop skills employers require.
- B are transferred to various posts.
- C should avoid making too many demands on employers.

33 Placements can offer the opportunity

- A to make an impact on the working environment.
- B to get to know important people in the area of work.
- C to meet new and interesting people.

34 Placements can lead to

- A future employment with the same organisations.
- B a better class of postgraduate degree.
- C greater influence with large organisations.

Questions 35-37

*Choose **THREE** letters, A-E.*

Students on placements could

- A help improve the quality of research within the organization
- B support people receiving long-term treatment following serious injury
- C run counselling sessions
- D have the chance to offer feedback on counselling sessions they attend
- E contribute to teacher-development programmes

Questions 38-40

Complete the notes below.

Write **NO MORE THAN THREE WORDS** for each answer.

It is the responsibility of the student **38** an interview.

It is **39** to have a CRB check when working with certain clients.

Forms for the CRB can be obtained from **40**

TEST 71

SECTION 1 Questions 1-10

Questions 1-4

Complete the form below.

Write **NO MORE THAN THREE WORDS AND/OR A NUMBER** for each answer.

Example	Answer
Modal	Ford Fiesta
Registration	1 3R1
Current mileage	2 miles
Estimated yearly mileage	6000 a year
Overnight parking	3



Cover 4 Third party
No claims bonus 6 years

Questions 5-7

Choose **THREE** letters, A-G.

Which additional cover does Liam want?

- A legal
- B 14-day cover courtesy car
- C driver injury
- D protected no claims bonus
- E breakdown
- F lost car key
- G windscreen

Questions 8-10

Complete the form below.

Write **NO MORE THAN THREE WORDS AND/OR A NUMBER** for each answer.

Name Liam Byrd
Address 35 Bottiville Crescent, Birmingham
Postcode 8.....
Date of birth 11/11/1969
Telephone 0121 677 9887
Payment by 9
Card number **** * 1551
Security number ***

How did the customer hear about Hartline? 10

SECTION 2 QUESTIONS 11-20

Questions 11-14

Complete the sentences below.

Write **NO MORE THAN THREE WORDS AND/OR A NUMBER** for each answer.

- 11 Ever year more than people try to climb Mont Blanc.
- 12 Approximately Reach the top every day in the summer months.
- 13 In July 2007 there were 30 fatalities, chiefly due to
- 14 One danger is caused by other climbers.

Questions 15-17

Choose the correct letter, A, B or C.

- 15 How did Katherine do her most recent climb?
A in a group
B with a guide
C on her own
- 16 Why did Katherine find her first climb of Mont Blanc difficult?
A because of poor weather conditions
B because of the time she was climbing
C because the route was crowded
- 17 What did Katherine do on her second climb that made it easier?
A She spent a few days in Chamonix beforehand
B She did the climb over two days

C She climbed smaller peaks for training

Questions 18-20

Choose **THREE** letters, A-F.

What has experience taught Katherine about climbing Mont Blanc?

- A Be in good physical condition
- B Have the right climbing equipment
- C Wear several layers of clothing
- D Protect yourself from the sun
- E Climb with others
- F Acclimatize yourself to the altitude first

SECTION 3 QUESTIONS 21-30

Questions 21-23

Write **NO MORE THAN THREE WORDS** for each answer.

- 21 When do Elaine and Adam decided to meet for revision?
- 22 What item does Adam think will help them work independently on revision?
- 23 How does Elaine suggest they spend their revision time between meetings?

Questions 24-28

Complete the sentences below.

Write **NO MORE THAN THREE WORDS** for each answer.

- 24 It's best to avoid taking notes
- 25 Relate to key theories and arguments
- 26 Using diagrams can help keep a lot of information
- 27 Bullet points can enable you to highlight
- 28 Keep a record of your sources, such as the

Questions 29-30

Choose the correct letter, A, B or C.

29 In future revision sessions Adam suggests using past papers

- A to try to predict future exam questions
- B to test each other
- C to discuss the questions

30 Elaine suggests

- A adding essay practice to the timetable
- B doing essays under exam conditions
- C asking a tutor to mark their essays

SECTION 4 QUESTIONS 31-40

Questions 31-33

Choose the correct letter, A, B or C.

31 According to the text, shared space

- A is very popular in the Netherlands
- B reduces the number of cars in an area
- C improves the dynamic between drivers and pedestrians

32 Shared space design results in

- A fewer road signs
- B stronger boundaries between pedestrians and motorists
- C increased local employment

- 33 Supporters of shared space argue that it
A leads to new businesses opening
B makes people happier to shop in the area
C encourages wildlife

Questions 34-37

Match the groups A-D with their concerns about shared space 34-37.

- A Motorists
B Blind people
C Cyclists
D Supporters of shared space
34 Insufficient experience amongst planners
35 A lack of important signage
36 Intimidation by motorists
37 The loss of familiar street furniture

Questions 38-39

Choose **TWO** letters, A-D.

People will be able to answer the questions

- A on the Internet
B at the local library
C at the proposed site
D at home

Question 40

Choose the correct letter, A, B or C.

Questions must be designed so that they

- A do not reflect the views of the campaign group
B do not require an understanding of shared space
C are easy to answer

TEST 72

SECTION 1 Questions 1-10

Questions 1-3

Complete the notes below.

Write **NO MORE THAN THREE WORDS AND/OR A NUMBER** for each answer.

Example Answer

The customer is going to France for 1 week

Traveler's cheques can be replaced within 1

Having a little cash is useful for things like 2

The bank charges for ATM withdrawals with a 3

Questions 4-7

Complete the table below.

Write **NO MORE THAN TWO WORDS AND/OR A NUMBER** for each answer.

Order	Collect in branch	Home delivery
Monday-Thursday 4 Befre p.m.	Next day 10 a.m.	Next day 5 p.m.
Friday-Saturday 6	Tuesday 10 a.m.	Tuesday 7 p.m.

Questions 8-10

Choose the correct letter, A, B or C.

8 The bank will buy back unused traveler's cheques

- A free of charge
- B for a small fee
- C if they are returned in good condition

9 Sandra does not want Euors because she

- A already has some
- B will be given some
- C will be buying some at the airport

10 On Tuesday Sandra will

- A collect the cheques from the branch
- B be at work
- C sign for the cheques at home

SECTION 2 QUESTIONS 11-20

Question 11

Choose the correct letter, A, B or C.

11 Nus extra cards

- A are offered free to all students.
- B are recognised internationally.
- C give you a year's-worth of discounts.

Question 12-15

Complete the notes below.

Write **NO MORE THAN THREE WORDS AND/OR A NUMBER** for each answer.

Student Raileards	
For young people between 16 and 25	
Mature students 25+ studying 12 _____	
Get 13 _____ train fares in the UK	
Discounts for theatre tickets and 14 _____	
1 year £28	
3 years 15 _____	

Questions 16-17

Choose **TWO** letters, A-E.

Local bus operators offer bus passes

- A especially for students.
- B for various lengths of time .
- C that are cheaper the longer the period.
- D for use only for commuting.
- E that can be used by your friends.

Questions 18-20

Write the correct letter, A, B, or C, next to questions 18-20

Which places are useful for the following?

- A Household items B Vintage clothes C Second-hand textbooks
- 18 The university campus
- 19 Charity shops
- 20 Car boot sales

SECTION 3 QUESTIONS 21-30

Questions 21-25

Complete the notes below.

Write **NO MORE THAN THREE WORDS AND/OR A NUMBER** for your answer.

Autumn term: Key dates	
Term starts	15 th September
Release timetables	15 th September
Release 21 _____	14 th October
All assignments online	by 22 _____
Release grades for first assignment	23 _____
Release 24 _____ for Belgium trip	29 th October
Belgium trip	25 _____

Questions 26-30

Choose the correct letter, A, B or C.

- 26 The college is trying to
 - A significantly reduce the amount of paper it uses.
 - B be careful about the amount of documents it produces.
 - C discover why students keep losing their work.
- 27 According to the text, students at the college
 - A are not allowed to print documents.
 - B have restrictions on how many pages they can print.

C have to pay to do any printing

28 The college

A has permission to reproduce the quizzes.

B wants the students to give them feedback about the quizzes.

C thinks the online quizzes are more effective than the paper ones.

29 The tutor explains that

A the quizzes are easy to find on the internet.

B the quizzes will be online for a few weeks only.

C the majority of the quizzes are online.

30 The online quiz system

A occasionally doesn't work.

B keeps the quiz results confidential.

C allows tutors to identify areas where the students may be having difficulties.

SECTION 4 QUESTIONS 31-40

Question 31-34

Complete the sentences below.

Write **NO MORE THAN THREE WORDS** for each answer.

31 _____ times are less common within the family.

32 We may eat more than we need due to our _____.

33 Eating habits can be affected by both _____ emotions.

34 People who are _____ are more likely to eat more due to negative emotions.

Question 35-39

Answer the questions below.

Which type of hunger relates to the points below?

Write **E** for emotional hunger. Write **P** for physical hunger.

35 Experiences a sudden urge to eat

36 Hungers for any type of food

37 Needs to satisfy the hunger as soon as possible

38 Will stop eating once full

39 Will feel no sense of guilt after eating

Question 40

Choose the correct letter, **A**, **B** or **C**.

40 People suffering from obesity can be helped by

A taking the pressure off them about feeling guilty.

B understanding why they have negative feelings.

C pinpointing stressful moments that can cause emotional hunger.

TEST 73

SECTION 1 Questions 1-10

Questions 1-3

Choose the correct letter, **A**, **B** or **C**.

Example

The customer is leaving from

1 The customer's coach departs at

A 1.00 pm

B 2.00 pm

C 3.00 pm



A Main Street

B Centenary Square

C Central Bus Station

3 The customer is going to London

A to attend a family party

B to see his daughter

C for a meeting

Questions 4-7

Complete the notes below.

Write **NO MORE THAN TWO WORDS OR A NUMBER** for each answer.

Kieren Coaches

Name: 4 Matthew

Address: 5 34

Telephone: 6 01732

Email: 7 matt @yahoo.co.uk

Questions 8-10

Choose the correct letter, A, B or C.

8 Apart from hand language, travelers

A must pay £10 for luggage

B can only take two additional suitcases

C are allowed up to 40 kilos of luggage free of charge

9 Travel insurance

A is included

B costs extra

C is compulsory

10 The customer decides to pay

A by credit card

B in cash

C by cheque

SECTION 2 QUESTIONS 11-20

Questions 11-13

Choose **THREE** letters, A-F.

Which **THREE** changes have been made to the library over the summer?

A new roof

B new computers

C new shelf units

D a self-service system

E meeting room decorated

F new furniture for the children

Questions 14-16

Write **NO MORE THAN THREE WORDS** for each answer.

WHICH THREE events does the speaker say are taking place in September?

14

15

16

Questions 17 and 18

Choose the correct letter, A, B or C.

17 The library needs a teacher for the Computer Club because

A the current teacher is leaving

B they are starting an additional group

C they want to start a higher-level class

18 Who does the library want older people to talk to about the past?

A teachers

B young children

C teenagers

Questions 19 and 20

Choose **TWO** letters A-E.

In addition to books, which two services does the mobile library offer?

A computer lessons

B a reservation service

C a reference section

D newspapers and magazine

E community service

SECTION 3 QUESTIONS 21-30

Questions 21-23

Complete the sentences below.

Write **NO MORE THAN THREE WORDS** for each answer.

21 The best days for engineering students are

22 Students can get useful suggestions about

23 Use the internet to look at before the event.

Questions 24-27

Choose the correct letter, A, B or C.

24 Fergus says that

A there is one company he is particularly interested in

B he has done some research already

C he knows the boss at one of the companies

25 The tutor thinks Fergus should

A prepare questions in advance

B research the skills required for jobs before the event

C find out what the starting salaries are

26 Fergus plans

A to wear a suit and tie

B to wear smart but casual clothes

C to buy an outfit for the event

27 The tutor suggests that Fergus

A should ask particular people certain questions

B should avoid taking free gifts

C should treat conversations like short interviews

Questions 28-30

Choose **THREE** letters A-F.

Why do the tutor and Fergus think it is useful to attend a jobs fair?

A to get a job

B to find out what employers want from you

C to give employers your contact details

D to discover which are the key companies to work for

E to practice your communication skills

F to make useful contacts

SECTION 4 QUESTIONS 31-40

Questions 31-33

Choose the correct letter, A, B or C.

31 According to the speaker,

A people were healthier in the past

B ancient bones need to be handled with care

C bones offer clues to a person's lifestyle

32 The island of Vanutau

A was not always inhabited

B had no food sources

C was the only island in Remote Oceania

33 Archaeologists wanted to discover

A what resources were available on the island

B if the settlers could rely entirely on local food sources

C the extent to which the settlers ate food they had brought with them

Questions 34-37

Complete the sentences below.

Write **NO MORE THAN THREE WORDS** for each answer.

34 Bones provide a dietary of the things people ate

35 Different ratios of carbon and sulphur are found in organisms depending on whether they come from the

36 Archaeologists analyzed modern and food sources for chemical elements

37 The settlers are wild creatures as well as

Questions 38-39

Choose **TWO** letters, A-D.

An analysis of the bones of men and women suggest that

A females ate more meat than males

B diet could have been determined by the job of the person did

C some people held higher status than others

D food was distributed equally among the settlers



Question 40

Choose the correct letter, A, B or C.

The bones of pigs and chickens indicate that these animals

A only ate food provided by the settlers

B were a main source of food for the settlers

C probably did not consume the settlers' limited food supplies

TEST 74

SECTION 1 Questions 1-10

Questions 1-3

Choose the correct letter, A, B or C.

Example

Jason says the house

A is close to the university

B is in the student area of town

C is near a bus service to the university

1 Katie thought the house

A would be too small for them

B would be quite cheap

C would not be like the advertisement claimed

2 Jason says

A Katie's parents would like the house

B there is no communal area in the house

C the house needs decorating

3 Jason likes the landlady because

A she used to be a student herself

B she has a lot of properties

C she takes care of the house

Questions 4-6

Choose **THREE** letters, A-G.

Which **THREE** of the following do the house and its vicinity have?

A a garden

B a washing machine

C an internet connection

D parking restrictions

E a modern kitchen

F a garage

G local shops

Questions 7-10

Complete the notes below.

Write **NO MORE THAN THREE WORDS OR A NUMBER** for each answer.

RENT DETAILS

Address: 7 94

Monthly rent: 8 £.....

9 rent to be paid as deposit



Telephone number 10 01764.....

SECTION 2 QUESTIONS 11-20

Questions 11-13

Choose the correct letter, A, B or C.

11 When Amanda was bitten,

A she felt a sharp pain in her foot

B she believed she was in serious trouble

C she started to shake all over

12 Amanda

A checked to see if there was anything in her shoes first

B found a fault in one of her shoes

C was aware of common ways of getting bitten

13 When Tony saw the spider,

A he picked it up

B he hit it with Amanda's shoe

C he covered it with a glass container

Questions 14-15

Complete the sentences below.

Write **NO MORE THAN TWO WORDS** for each answer.

FIRST AID ADVICE

Place a(n) 14 over the bite to relieve the pain.

Do not place a(n) 15 over the bite as this can cause future pain.

Questions 16-18

Choose **THREE** letters, A-E.

Which **THREE** symptoms did Amanda have before going into hospital?

A a painful lower leg

B feeling sick

C a fever

D a headache

E a swelling

Questions 19 and 20

Complete the sentences below.

Write **NO MORE THAN TWO WORDS OR A NUMBER** for each answer.

19 Following treatment, symptoms can sometimes take a few to clear up.

20 Amanda flew home later.

SECTION 3 QUESTIONS 21-30

Questions 21-25

Choose the correct letter, A, B or C.

21 Kevin has lectures

A three days a week

B on Wednesdays

C four days a week

22 What does Kevin say about going home?

A He last went home in September

B It is too expensive to travel by train



- C He has been back home once
23 Kevin thinks living in halls of residence
A is cheaper than renting a house
B is a good way of getting to know people
C means it is difficult to use the kitchen
24 Kevin joined the Spanish Society because
A he wanted to learn how to cook
B someone told him it was good
C he knows people who are members
25 The tutor says it is important for students to structure their time because
A they have more independence at university
B they have too much freedom
C it is the best way to get top grades in their work

Questions 26-30

Complete the sentences below.

Write **NO MORE THAN THREE WORDS OR A NUMBER** for each answer.

Writing Tutorial Service

Get feedback on your academic writing skills!

Send us a piece of work along with a completed 26

The team may not be familiar with your subject, so try one of the general 27 you will on our webpage.

When applying for a tutorial, tell us when you are 28

We usually arrange to see you within 29 of receiving your application.

Under normal circumstances, students will be able to meet the team once every 30.....

SECTION 4 QUESTIONS 31-40

Questions 31 and 32

Choose the correct letter, A, B or C.

31 According to the speaker, which of the following models emerged first?

- A equity-based crowdfunding
- B micro-landing
- C fan-based crowdfunding

32 The fan-based model offers

- A shares
- B a financial return
- C a reward

Questions 33-40

Complete the sentences below.

Write **NO MORE THAN TWO WORDS** for each answer.

Crowdfunding explained

- The project and financial target are explained on the crowdfunding website.
- Each fundraising initiative has a set 33 limit.



- For a film, people could expect anything from free tickets to having their name listed in the 34

Crowdfunding opportunities

- Companies can receive small donations from a(n) 35 of people.
- Partner companies can help as part of their own fundraising events.
- You can get 36 from supporters during the development phase.
- Crowdfunding will increase 37 of the product and potentially improve sales.

Crowdfunding dangers

- You must reach your target or donations that are 38
- It can take a lot of time to fulfil the promises you have made to fans.
- Don't forget to consider the cost of 39 when working out profits.
- Raising awareness is hard if your company is 40 or if you don't have many social media followers.

TEST 75

SECTION 1 Questions 1-10

Questions 1-3

Choose the correct letter, A, B or C.

Example

What has the patient just had?

A tooth out

B his teeth cleaned

C an X-ray

1 On which day can the patient make an appointment?

A Monday

B Tuesday

C Wednesday

2 The patient has to wait for an appointment because

A the surgery is closed for a holiday

B there are fewer dentists available

C a dentist has called some appointments

3 The patient books an appointment at

A 1.30

B 3.30

C 4.00

Questions 4-6

Complete the notes below.

Write **NO MORE THAN TWO WORDS OR A NUMBER** for each answer.

Costs of treatment.

Fillings £55

Extractions £90

X-rays 4 £.....

We require 5 hours of notice of a cancellation, otherwise a fee of £10 is charged.

Cheques should be made payable to 6 Dental Surgeons.

Questions 7-10

Complete the notes below.

Write **NO MORE THAN TWO WORDS** for each answer.

Dental Insurance

We cover up to £650 worth of treatment very 7

Get big discounts on insurance cover for the whole 8

You can pay 9 and no interest is charged.

Cover begins immediately your 10 starts.

SECTION 2 QUESTIONS 11-20

Question 11

Choose the correct letter, A, B or C.

The main aim of the arts festival is to

- A support the creative industries
- B increase the number of spectators
- C get more people into the creative arts

Questions 12 and 13

Choose **TWO** letters, A-E.

Which **TWO** things does the speaker say about doing something creative?

- A It is best to attend a workshop.
- B It can remind you of your childhood.
- C It can give joy to other people.
- D You may be surprised how talented you are.
- E You can become more interested in the world around you.

Questions 14-17

Which groups of people can do the following activities?

Write the letters A, B, C or D next to Questions 14-17.

- A older people
- B any interested people
- C the unemployed
- D creative people

- Activities**
- 14 Create your own Artwork
 - 15 Walk for Creativity
 - 16 Work with Children
 - 17 Learn the Art of Story-telling

Questions 18-20

Complete the sentences below.

Write **NO MORE THAN TWO WORDS OR A NUMBER** for each answer.

Sessions must be 18 in advance.

All workshops are free of charge and 19 will be provided.

The office is open from 9-5, Monday-Friday, and until 20 on Saturdays.



SECTION 3 QUESTIONS 21-30

Questions 21-23

What does Judy say about the following courses?

Write the correct letter, A, B or C next to Questions 21-23.

- A She transferred from this course.
- B She transferred to this course.
- C Her transfer request was turned down for this course.

- 21 Fine Art
- 22 History of Art
- 23 English

Questions 24-26

Choose **THREE** letters, A-G.

Which **THREE** reasons does Graham give for wanting to transfer?

- A The German course is too difficult
- B He does not like the people he is studying with
- C He has more interest in history
- D He plans to do a combined degree
- E It suits his career plans
- F He is not bothered that he will not spend a year abroad
- G His housemate has persuaded him to transfer

Questions 27-30

Complete the sentences below.

Write **NO MORE THAN THREE WORDS** for each answer.

Transferring to another course at the university.

Step 1: Identify your reasons for wanting to transfer.

Step 2: Check that you satisfy the **27** for the newcourse.

Step 3: Speak with the Careers Service.

Step 4: Find out if there are any **28** implications.

Step 5: Speak to the Admissions Tutor in the department you want to transfer to.

Step 6: Complete a(n) **29** Form.

Please note: The form must also be signed by the **30** of your current course and the one you are transferring to.

SECTION 4 QUESTIONS 31-40

Choose the correct letter, A, B or C.

31 The symptoms of synesthesia

- A are the same for everyone with the condition
- B cannot be controlled
- C can be harmful

32 People who discover that they have synesthesia

- A often say they thought everyone experienced it
- B express negative feelings about their condition
- C wonder what it is like to be normal

- 33** One research project looking at synesthesia
A produced different result from other research
B was able to estimate the proportion of people with the condition
C found that a small number of people saw different colours
- 34** The condition means some people see numbers or letters
A as either red or blue
B as days or months
C as colours or in particular relative positions
- 35** The way people experience colours
A will be exactly the same for everyone
B can lead to disagreements
C differs when a large number of experiments are carried out
- 36** When seeing certain words, people with word-taste synesthesia
A will differ in the way they 'taste' a word
B generally get a sweet taste in their mouth
C have similar experiences
- 37** What does the speaker say about synesthesia?
A Infants may all have the condition
B It is difficult to prove that the condition exists
C The condition becomes more noticeable during childhood
- 38** Family members with synesthesia
A are not always closely related.
B may not have the same symptoms
C make up forty per cent of the extended family
- 39** People with synesthesia
A are advised to take up a hobby or interest
B are often talented artists
C often take an interest in the arts
- 40** What attitude do scientists have towards synesthesia nowadays?
A It has little scientific worth
B It may help them better understand how the brain functions
C They need more proof that it exists

TEST 76

SECTION 1 Questions 1-10

Complete the notes below.

Write **NO MORE THAN THREE WORDS OR A NUMBER** for each answer.

Example

The woman was getting something for lunch when the accident happened.

Accident report

Time of accident: **1**

Driver failed to stop at the junction of Monks Road and High Street.

There were **2** people in the car, all around 20 years old.

The car hit a woman on her **3**

The car was last seen heading towards the 4

The 5 at the junction out of order.

The car may have been a red Ford Fiesta. One of the car doors is 6

Registration number: 7 Y48.....

Witness name: 8 Rita

Address: 9 19,

Telephone number: 0232 566788

Mobile number: 10 07834.....

SECTION 2 QUESTIONS 11-20

Questions 11 and 12

Choose the correct letter, A, B or C.

11 The speaker says solar panels
A are expensive
B should be considered more seriously
C are not very popular

12 In the speaker's opinion, most people
A neglect to turn the heating down
B wash their clothes too often
C do not use the kitchen efficiently

Questions 13-20

Complete the notes below.

Write **NO MORE THAN THREE WORDS OR A NUMBER** for each answer.

Energy-saving tips

- Living in **13** accommodation? Check windows and doors for draughts.
- Don't leave laptops and TVs on **14** overnight.
- Don't use **15** than you need when making hot drinks.
- Put **16** pots and pans when building water.
- Where possible, avoid placing the refrigerator next to the **17**
- Remember to turn down the fridge temperature control in the **18**
- Don't forget to **19** the freezer and don't put too much food in it.
- Reduce the temperature of your washing machine to **20** degrees.

SECTION 3 QUESTIONS 21-30

Questions 21-25

Choose the correct letter, A, B or C.

21 What did Alice do when she first arrived at the university Open Day?

- A** She had a coffee
- B** She looked around the campus
- C** She went to one of the events

22 Which of the following is NOT on the campus?

- A** a supermarket
- B** a bank
- C** a bookshop

23 Why does Oliver think it is a good idea to register?

- A** The university will know you attended
- B** You get an information pack

C You cannot attend events unless you register

24 What is the main factor for Alice in her choice of university?

A its facilities

B its links to industry

C the number of mature students

25 Which area of work is Oliver interested in?

A teaching

B finance

C software development

Questions 26-28

What does Alice say about the events in the afternoon?

Write the correct letter, A, B or C next to Questions 26-28.

- A she will attend
B she might attend
C she will not attend

- 26** a talk about the year abroad
27 the exhibition in the Physics Department
28 a talk by the head of the department

Questions 29 and 30

Choose the correct letter, A, B or C.

29 Which employers offer only unpaid work?

A accountancy firms

B the university

C campus retail outlets

30 Oliver

A plans to live at home if he gets a place at the university

B will live on campus if he gets a place at the university

C does not yet know where he will live if he gets a place at the university

SECTION 4 QUESTIONS 31-40

Complete the lecture notes below.

Write **NO MORE THAN TWO WORDS** for each answer.

Pygmy Blue Whale Research

- Pygmy blue whales: Before 1966 it is likely they were **31**..... With the Antarctic blue whales.
- Aim of study: To find out more about their **32** and movements.
- Method: Whales are tagged with an antenna. When the antenna communicates with a number of satellites, the whale's **33** can be identified. Researchers access the results using the project **34**
- Findings: The whales travel from the **35** of Australia to breeding grounds in Indonesia during March and April, and return to Australian waters in **36** Pygmy whales do not give without **37** whilst they are in their breeding grounds.
- Conversation issues: The effect of **38** routes on communication between whales.
Conservation efforts can take place over a(n) **39** area now there is evidence that they migrate out Australian waters.



- Future studies: To explore whether pygmy whales off the southern coast of Australia follow the same northerly migratory routes as those studied or whether they travel a(n) **40** region to the south of Australia.

TEST 77

SECTION 1 Questions 1-10

Questions 1-7

Complete the notes below.

Write **NO MORE THAN THREE WORDS AND/OR A NUMBER** for each answer.

Notes—Clark's Bicycle Hire

Example

Type: ... *touring* ... bike

Rental: £50 a week, or **1** £ a day

Late return fee: **2** £ per extra hour

Deposit: **3** £ returnable

Accessories: £5 for **4**: pannier or handlebar type

free: pump

repair kit

5 strong

Insurance: included, but pay first **6** £ of claim

Pay: by **7** only

Questions 8-10

Label the map.

Choose your answers from the box.

- A health centre
- B Maple Leaf club
- C Clark's Cycle Hire
- D supermarket
- E garage

Woods Road

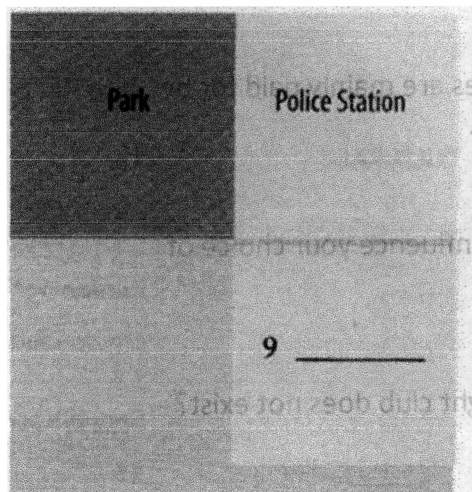

Oak Street

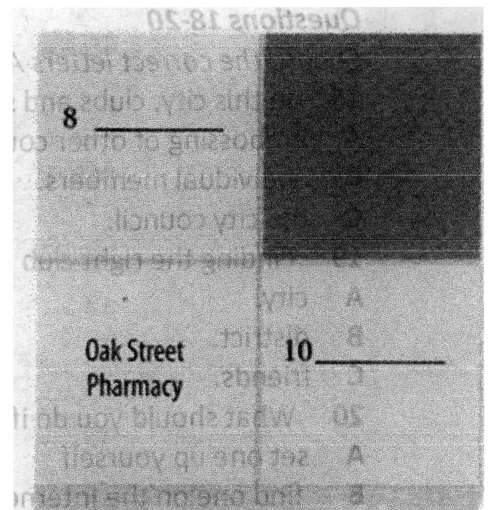

SECTION 2 QUESTIONS 11-20

Questions 11-17

Complete the table below.

Write **NO MORE THAN THREE WORDS** for each answer.

TYPE OF CLUB OR SOCIETY	EXAMPLES
SPORTS	rugby tennis
HOBBY/INTEREST	landscape photography 11
12	dancing speed-dating
RELIGIOUS	
INTERNATIONAL/CULTURAL	13 Afro-Caribbean
14	human rights environmental
15	Republicans 16
PERFORMING ARTS	17 amateur theatre

Questions 18-20

Choose the correct letters A-C.

- 18** In this city, clubs and societies are mainly paid for by
A embossing of other countries.
B individual members.
C the city council.
- 19** Finding the right club might influence your choice of
A city.
B district.
C friends.
- 20** What should you do if the right club does not exist?
A set one up yourself
B find one on the Internet
C join one in another town



SECTION 3 QUESTIONS 21-30

Questions 21-25

Label the flow chart.

*Write **NO MORE THAN THREE WORDS AND/OR A NUMBER** for each answer.*

LECTURES AND NOTE TAKING

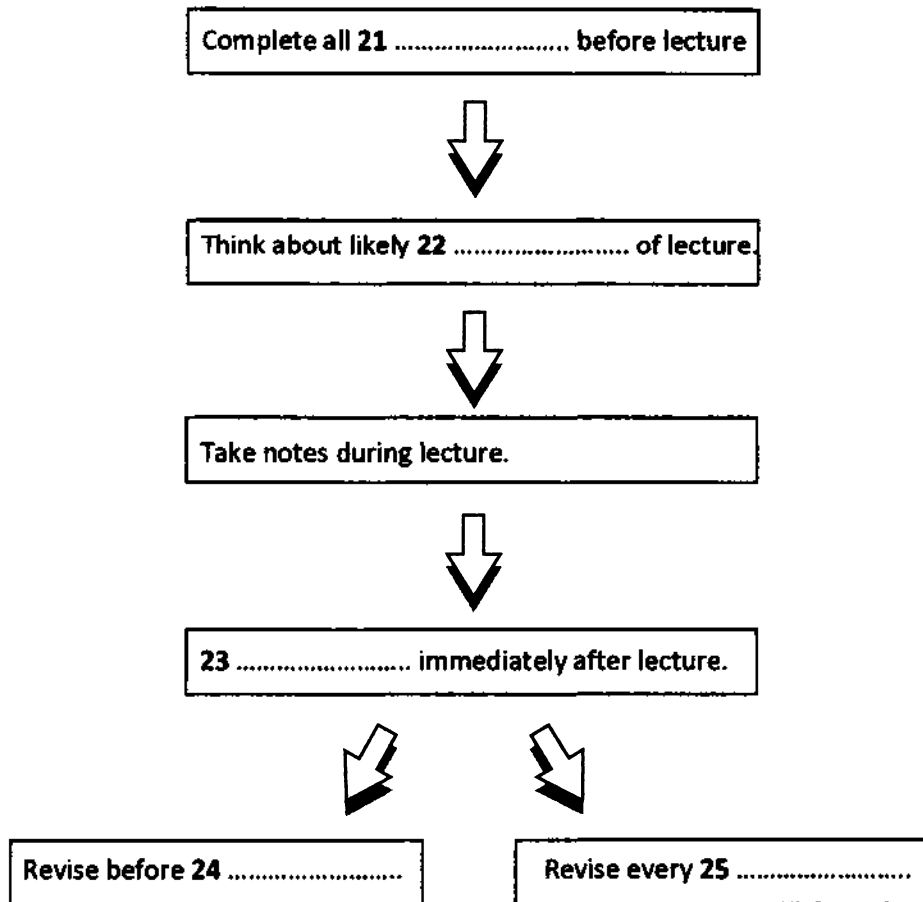

Questions 26-29

*Write **NO MORE THAN THREE WORDS** for each answer.*

- 26 Where should you sit when you attend a lecture?
- 27 What should you do if you miss an important point?
- 28 Why must your notes be easy to read?
- 29 What do we call expressions which indicate what is coming next?



Question 30

Circle the correct letter A, B, C or D.

30 Where does Carlos write summing-up points on his notes?

Summing-up points

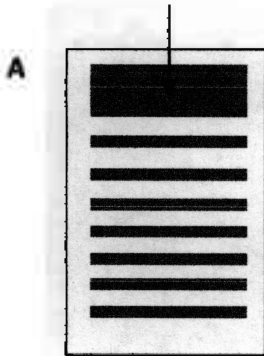

Summing-up points

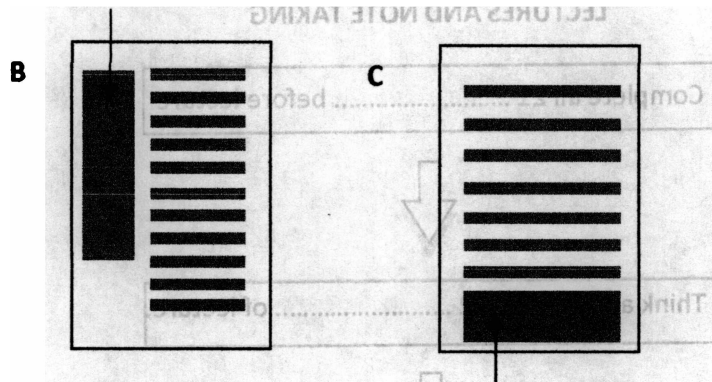

C

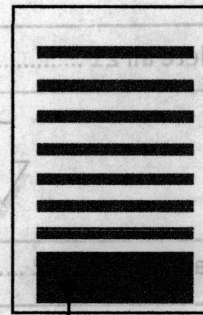

D

Summing-up points

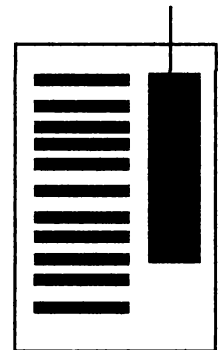

Summing-up points

SECTION 4 QUESTIONS 31-40

Questions 31-36

Complete the summary below by writing **NO MORE THAN THREE WORDS** in the spaces provided.

The Australian mining town of Coober Pedy is about **31** kilometers south of Alice Springs. Opals were first found in the area in **32** and people began to settle there after the **33** In the late 1940s, new opal fields and mass immigration from **34** created a boom, despite the extreme climate which forced about **35** of the population to live underground, where they built hotels, churches, and the world's only underground **36**

Questions 37-40

Write the appropriate letters A, B, or C.

<i>Example</i>	<i>Answer</i>
The conical hills	B
37 the town of Woomera	
38 the opal museum	
39 the Dingo Fence	
40 the sets of films	

- A in the town of Coober Pedy
- B near Coober Pedy
- C far from Coober Pedy

TEST 78

SECTION 1 Questions 1-10

Questions 1-6

How does the owner answer? Write

- A if she says YES, DEFINITELY
- B if she says MAYBE
- C if she says DEFINITELY NOT

Example House free of damp? *Answer B*

- 1 Current gas safety certificate?
- 2 Gas inspection within last twelve months?
- 3 Electricity checked in last five years?
- 4 Sufficient electric sockets?
- 5 Fire detection equipment that works?
- 6 Previous tenants all returned keys?

Questions 7-10

- 7 On which floor is the storeroom?
 - A first
 - B second
 - C third
- 8 What is the temperature of the hot water?
 - A 55°
 - B 60°
 - C 70°
- 9 How big is the garden?
 - A 20 m²
 - B 90 m²
 - C 150 m²
- 10 What size is the television?
 - A 70 cm
 - B 80 cm
 - C 90 cm

SECTION 2 QUESTIONS 11-20

Questions 11-12

Choose the correct letters A-C.

- 11 Which column of the chart shows the percentage of young people suffering loneliness?
 - A 16%
 - B 32%
 - C 68%
- 12 Which chart shows the percentage of young people using the counseling service?

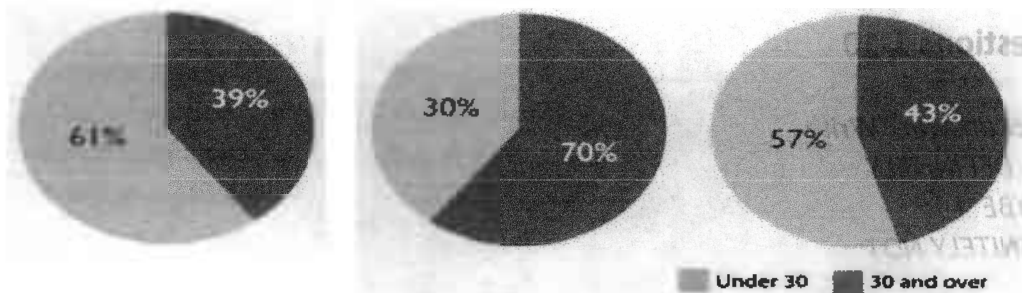

Questions 13-20

Complete the sentences below.

Write **NO MORE THAN THREE WORDS** for each answer.

- Many young people feel lonely during their **13** away from home.
- You may feel lonely even though you are often with **14**
- People may find it easier to adapt if they have been **15** before.
- It's possible you last needed to make new friends at **16**
- Someone special to you may live **17** from you.
- Don't forget that **18** is affected by loneliness.
- Doing interesting **19** is a good way to meet new people.
- The **20** at your town hall can tell you more about counselling.

SECTION 3 Questions 21-30

Questions 21-23

What does Katy say about the Language Centre?

- A It is near the College
- B The library's materials are for advanced learners only
- C All books have accompanying cassettes
- D It receives a Spanish newspaper every day
- E At present, at least fifteen languages are taught by computer
- F All the computers can be used for Internet learning

Question 24

Choose **TWO** letters A-E

Which of the following can you watch on the second floor?

- A live TV in English
- B live TV in Japanese
- C live TV in Turkish
- D recorded news in Arabic
- E recorded news in Portuguese

Questions 25-27

Circle **THREE** letters A-F.

What must you do when you join the Language Center?

- A pay a small amount of money
- B show some proof of identity
- C be accompanied by someone from your Department
- D take a test in the language you want to study
- E register at Reception in the Language Centre



F learn how to use the Centre's equipment

Questions 28

Choose **TWO** letters A-E

Which **TWO** should you tell the librarian?

A whether you have studied the language previously

B why you want to study this language

C how many hours per week you must study it

D which text books you will use

E which other languages you have learned

Question 29 and 30

Circle **TWO** letters A-E

Which **TWO** of these can you do at the Language Centre?

A read and listen to materials on your own

B choose books to take away from the Centre

C copy tapes to listen to them outside the Centre

D photocopy materials yourself

E have a few pages of a book photocopied

SECTION 4 Questions 31-40

Questions 31-34

Write **NO MORE THAN TWO WORDS OR A NUMBER** for each answer.

The zip				
1851	Howe	'Automatic Continuous Clothing Closure'	commercial potential only	USA
1893	Judson	'Clasp Locker'	commercial failure	31
1908	Sundback	'Hookless Fastener'	commercial 32	Sweden
33	Kynoch	'Ready Fastener'	commercial success	UK
1920s	34	'Zipper'	commercial success	USA

Questions 35-39

Label the zip.

Write **NO MORE THAN THREE WORDS** for each answer.



The Separating Zip Fastener

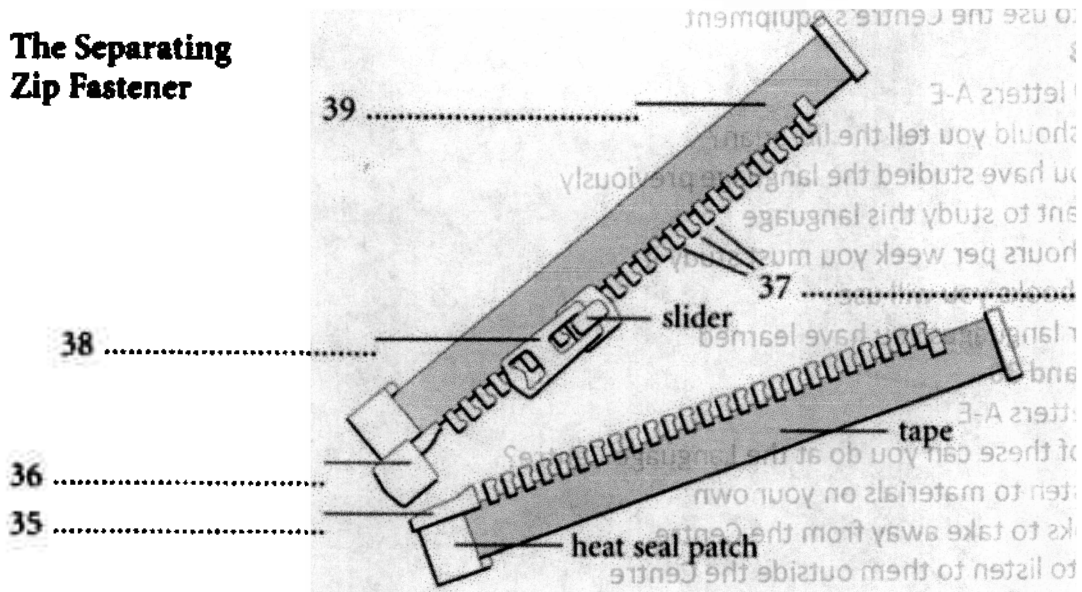

- 40 The speaker's overall aim is to
- A explain how different kinds of zip fastener work
 - B outline the development of the zip fastener
 - C advertise a particular kind of zip fastener
 - D warn of the dangers of zip fasteners

TEST 79

SECTION 1 Questions 1-10

Questions 1-6

What does Lisa say about each object?

- A if she says it is **ESSENTIAL**
- B if she says it is **RECOMMENDED**
- C if she says it is **NOT RECOMMENDED**

Example Documents Answer A

- 1 At least £50
- 2 Warm clothing
- 3 Personal computer
- 4 Food from home
- 5 Favorite tapes or CDs
- 6 Photos from home

Questions 7-10

Complete the sentences below.

Write **NO MORE THAN THREE WORDS** for each number.

The labels on Dan's luggage must state 'Mr & Mrs 7' and their address.

Lisa says he should carry some spare clothes in 8

For health reasons, Dan intends to wear 9 during the flight.

Dan should practice carrying his luggage for a minimum distance of 10

SECTION 2 Questions 11-20

Questions 11-13

Choose **THREE** letters A-F.

What does Sally say about universities?

- A Compared to the general population, few students are disabled
- B Most universities don't want students aged over 25
- C Old universities can present particular difficulties for the disabled
- D All university buildings have to provide facilities for the disabled
- E There are very few university disability advisors
- F Some disability advisors can do little to help disabled students

Questions 14-19

Complete the table below.

Write **NO MORE THAN THREE WORDS** for each answer.

Disability	Facilities
General	personal care and assistance
Mobility impairment	ramps and easy access, fire and emergency procedures 14 lavatory facilities
15	induction loops, flashing sirens, 16
Sight impairment	Braille translators, 17 on stairs, floors, etc fire and emergency procedures
Dyslexia	use of computer 18 to finish work
Other difficulties	access to treatment: medication/therapy 19 procedures

Question 20

Choose the correct letter, A, B, C or D.

20 What is the speaker's main purpose?

- A to explain why comparatively few students are disabled
- B to advise disabled students what to look for in a university
- C to describe the facilities for the disabled in a particular university
- D to criticize the facilities for the disabled in most universities

SECTION 3 Questions 21-30

Questions 21-26

Complete the notes below using letters A-F from the box.

NB You may use any letter more than once.

- A tour of the university campus
- B formal dinner party
- C meeting with senior students
- D driving in this country
- E visit to a night club
- F tour of the city

Orientation Course for international students

What Liz liked about the course.

21

22

23

What Mark thinks could be improved

24

25

26

Questions 27-30

Choose the correct letter A, B, C, or D.

27 Your room during the Orientation Course is

- A usually shared with another students
- B the same room you will have for the rest of the year
- C some distance from the university
- D furnished, and with bedclothes provided

28 The daytime temperature will be probably be

- A less than 10C
- B between 10C and 20C
- C 20C
- D more than 20C

29 How much free email time do you get?

- A 30 minutes
- B 20 minutes
- C 15 minutes
- D 10 minutes

- 30 There are Orientation course activities from
 A Sunday to Saturday
 B Sunday to Friday
 C Monday to Friday
 D Monday to Saturday

SECTION 4 Questions 31-40

Questions 31-33

Complete the sentences below.

Write **NO MORE THAN TWO WORDS** for each answer.

Fireworks were first used in China, probably in the 31 century.

By the following century, they were known in Arabia as 32

Fireworks first appeared in 33 in the thirteenth century.

Questions 34-37

Label the diagram.

Write **NO MORE THAN THREE WORDS** for each answer.

Firework Mortar

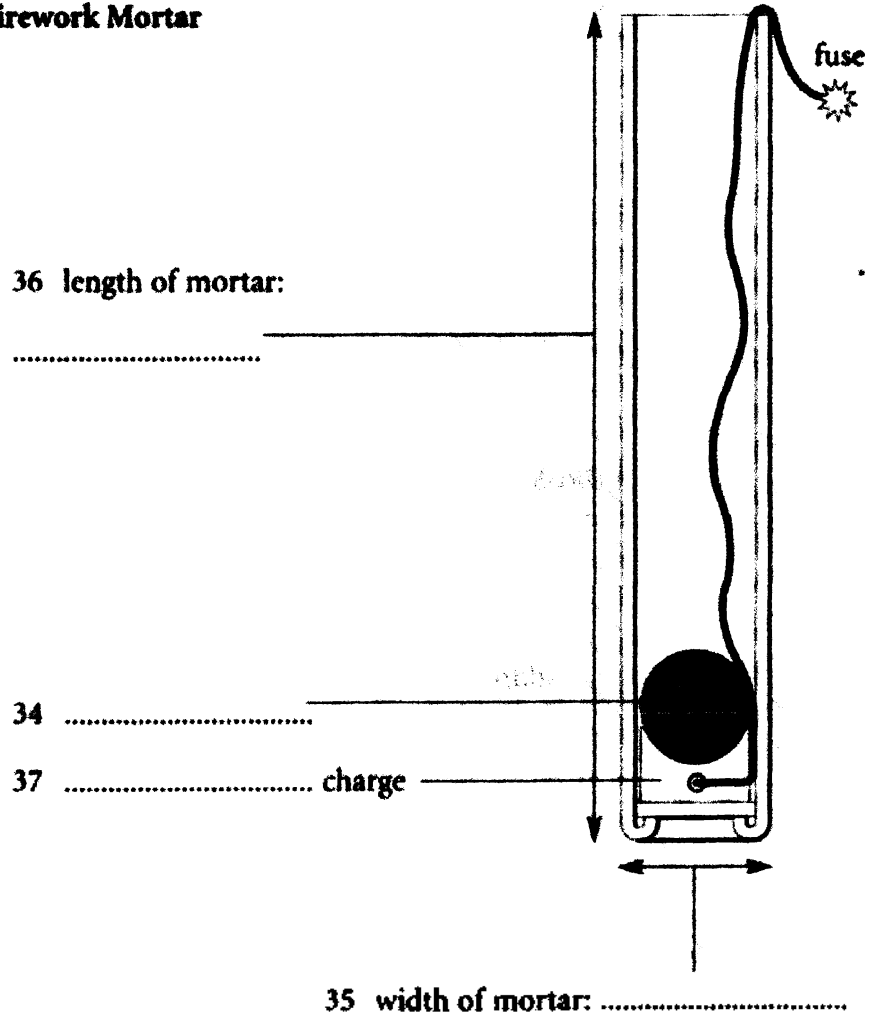



Where? 6

Free gift? 7

Questions 8-10

Match the places in Questions 8-10 to the appropriate letters A-H on the map.

8 Royal Bank

9 Northern Bank

10 National Bank

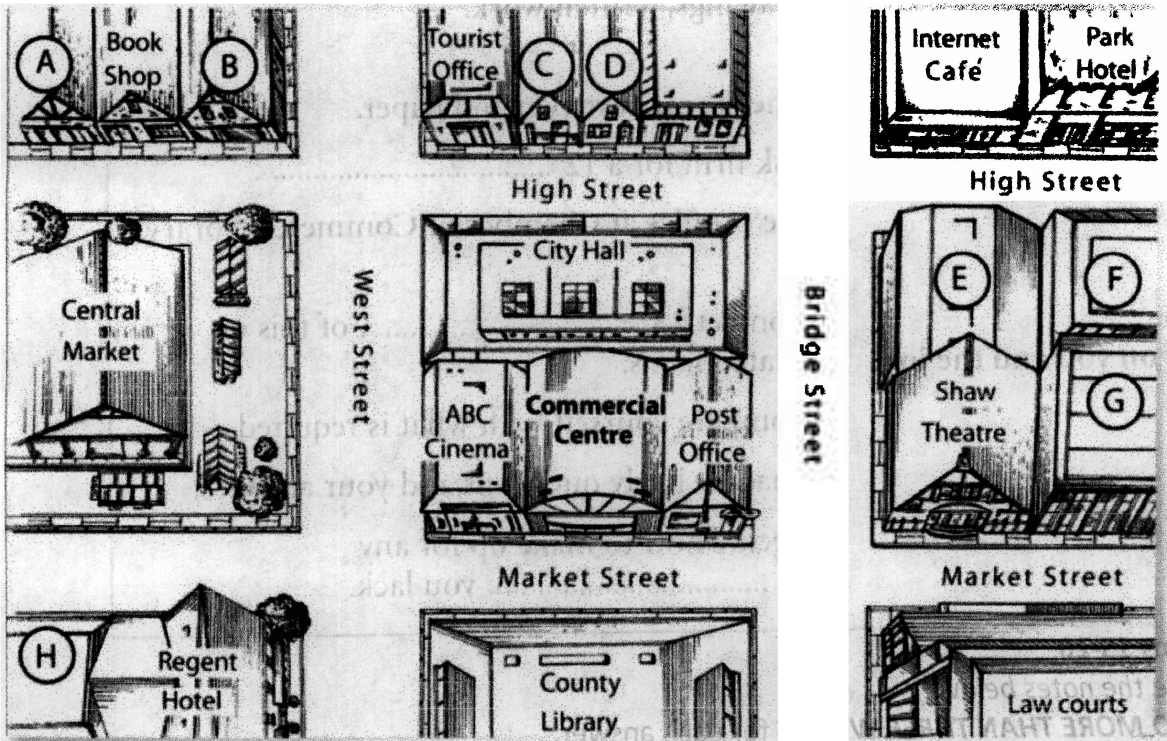

SECTION 2 Questions 11-20

Questions 11-14

Complete the table below.

Write **NO MORE THAN THREE WORDS** for each answer.

Preparing for the interview

What to do

How to do it

Step 1:
Prepare things to take.

Gather all documents, e.g. copies of résumé.
Choose 11 , e.g. designs,
drawings, written work.

Step 2:
Get more information.

Check you have pen and paper.
Ask firm for a 12
See profiles at Chamber of Commerce, library.

Step 3:
Focus on you and the job.

Contact 13 of this or
related firms.
Compare yourself with what is required.
Imagine likely questions and your answers.
Decide how to make up for any
14 you lack.

Questions 15-20

Complete the notes below.

Write **NO MORE THAN THREE WORDS** for each answer.

At the interview.

- Arrive no more than **15** before the time of the interview.
- After you hear the question, you can **16** before you reply.
- You can **17**if you don't understand what they're asking
- Wait for them to offer you the job before you saw what **18** you want.
- Learning from the experience will make you more **19** in future interviews.
- Pay attention to your **20** – it shows you have a positive attitude.

SECTION 3 Questions 21-30

Questions 21-24

*Complete the summary below by writing **NO MORE THAN THREE WORDS** in the spaces provided.*

To many employers, academic success and personal development as a result of being at **21** can be as important as course content, so choose **22** Modules that you may do well in. You should, however, think more carefully about your choice if your course is **23** In this case the course normally includes all the modules necessary for professional training, but if you are in any doubt check with your academic department or the **24** at the university.



Questions 25-29

Write the appropriate letters A-C against questions 25-29

Which modules have the following features?

A Applied Chemical Engineering

B Fluid Mechanics

C Chemical Engineering Science 1

25 developing computer skills

26 exemption from part of a different module

27 assessment by formal examination

28 developing speaking and writing skills

29 learning through problem solving

Question 30

30 Which chart shows the percentage of private study time on the Spanish 1A module?

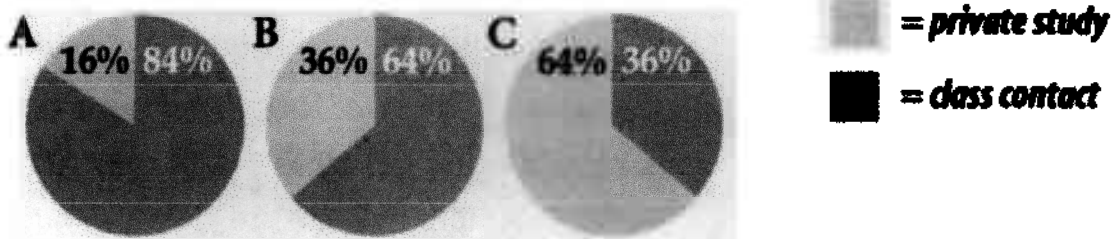

SECTION 4 Questions 31-40

Questions 31-33

Label the diagram.

Write **NO MORE THAN TWO WORDS AND/OR A NUMBER** for each answer.

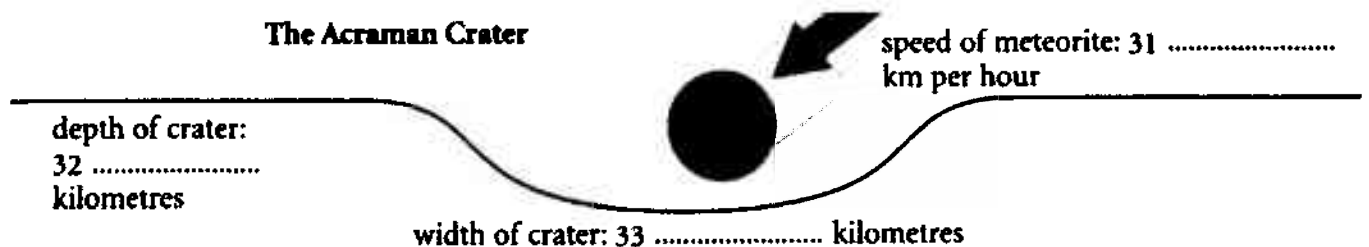

Questions 34-36

Choose from letters A-C and write them on your answer sheet.

34 The crater at Acraman is

A nowadays entirely covered by sea water

B one of the most beautiful on Earth

C less spectacular than others in Australia

35 Williams realized what had happened at Acraman when he

A saw pictures of the area taken from above



B visited Acraman for the first time in 1980

C noticed a picture of crate in a textbook

36 Where was rock from Acraman found

A Only in the Flinders mountains

B At several places over 300 km from Acraman

C At a palace 500 km from Acraman, but nowhere else.

Questions 37-40

Write **NO MORE THAN THREE WORDS** for each answer.

37 What made the sea water shake?

38 What threw the pebbles into the air?

39 What was mixed with silt to form a layer of rock?

40 What shaped their ripples on top of the rock?