



# chinese english



OVER 6,000 WORDS  
AND PHRASES

BILINGUAL  
DICTIONARY

VISUAL  
SOUND







Bilingual  
**VISUAL**  
dictionary

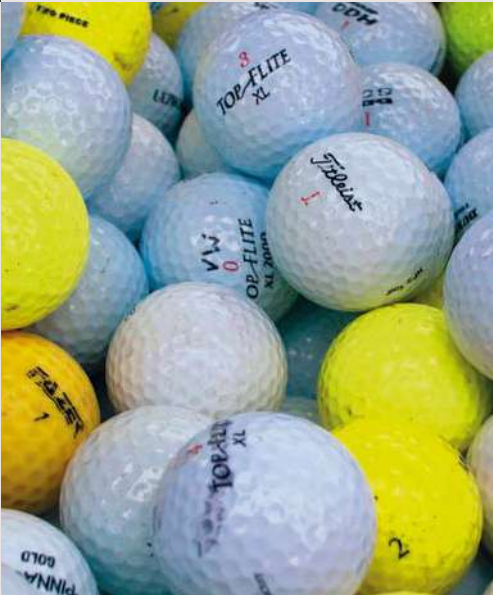
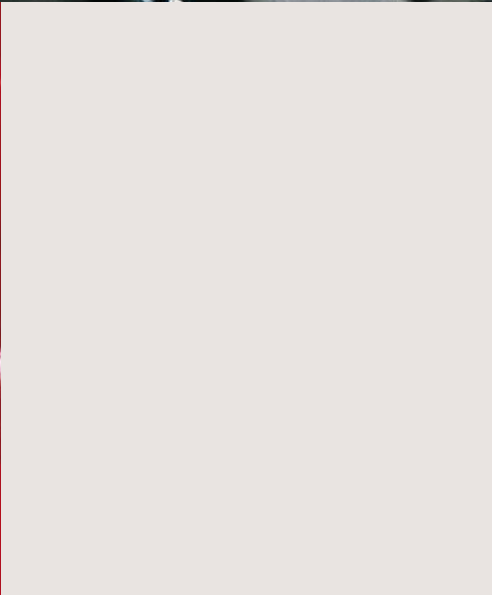
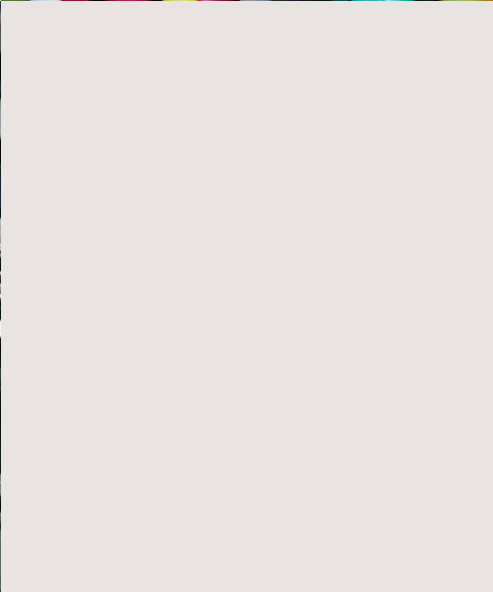
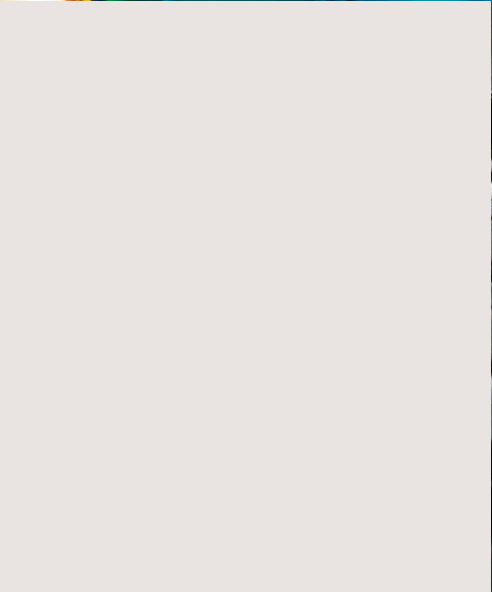

# Bilingual **VISUAL** dictionary



A DORLING KINDERSLEY BOOK

London, New York, Melbourne, Munich, Delhi

Senior Editor Angela Wilkes  
Senior Art Editor Vicky Short  
DTP Designer Deeraj Arora  
DTP Coordinator Balwant Singh  
Production Editor Lucy Baker  
Production Controller Rita Sinha  
Managing Art Editor Christine Keilty

Designed for Dorling Kindersley by WaltonCreative.com  
Art Editor Colin Walton, assisted by Tracy Musson  
Designers Peter Radcliffe, Earl Neish, Ann Cannings  
Picture Research Marissa Keating

Language content for Dorling Kindersley by  
g-and-w PUBLISHING

Managed by Jane Wightwick, Shuang Zou  
Translation by Foreign Language  
Teaching & Research Press  
Pinyin transcription by Lin Jing

First published in Great Britain in 2008 by  
Dorling Kindersley Limited,  
80 Strand, London WC2R 0RL

A Penguin Company

2 4 6 8 10 9 7 5 3 1

Copyright © Dorling Kindersley Limited 2008  
Copyright Chinese translation © Foreign Language  
Teaching & Research Press (FLTRP) 2008

All rights reserved. No part of this publication may be reproduced, stored in a retrieval system, or transmitted in any form or by any means, electronic, mechanical, photocopying, recording, or otherwise, without the prior written permission of the copyright owner.

A CIP catalogue record for this book is available from  
the British Library

ISBN 978 1 4053 2916 3

Printed by L. Rex Printing Co. Ltd, China

Discover more at  
[www.dk.com](http://www.dk.com)

## 目录 mùlù contents



42

健康  
jiànkāng  
health



146

外出就餐  
wàichūjiùcān  
eating out



252

休闲  
xiūxián  
leisure



6

词典介绍  
cídiǎnjièshào  
about the dictionary



8

使用说明  
shǐyòng shuōmíng  
how to use this book



10

人  
rén  
people



28

外表  
wàibiǎo  
appearance



56

家居  
jiājū  
home



92

服务  
fúwù  
services



102

购物  
gòuwù  
shopping



116

食物  
shíwù  
food



160

学习  
xuéxí  
study



170

工作  
gōngzuò  
work



192

交通运输  
jiāotōng yùnshū  
transport



218

体育运动  
tǐyù yùndòng  
sports



278

环境  
huánjīng  
environment



302

日常便览  
rìcháng biànlǎn  
reference



324

索引  
suǒyǐn  
index



360

鸣谢  
míngxiè  
acknowledgments



## 人 rén • people

人体 réntǐ   body	12
面部 miànbù   face	14
手 shǒu   hand	15
脚 jiǎo   foot	15
肌肉 jīròu   muscles	16
骨骼 gǔgé   skeleton	17
内脏 nèizàng internal organs	18
生殖器官 shēngzhíqìguān reproductive organs	20
家庭 jiāting   family	22
人际关系 rénjìguānxì relationships	24
情感 qínggǎn   emotions	25
人生大事 rénshēngdàshì life events	26

## 外表 wàibiǎo • appearance

童装 tóngzhuāng children's clothing	30
男装 nánzhuāng men's clothing	32
女装 nǚzhuāng women's clothing	34
配饰 pèishì   accessories	36
头发 tóufà   hair	38
美容 měiróng   beauty	40

## 健康 jiànkāng • health

疾病 jíbìng   illness	44
医生 yīshēng   doctor	45
创伤 chuāngshāng   injury	46
急救 jíjiù   first aid	47
医院 yīyuàn   hospital	48
牙医 yáyī   dentist	50
配镜师 pèijìngshī   optician	51
怀孕 huáiyùn   pregnancy	52

分娩 fēnmiǎn   childbirth	53
替代疗法 tìdài liáofǎ alternative therapy	54

## 家居 jiājū • home

房屋 fángwū   house	58
室内系统 shìnèi xìtǒng internal systems	60
起居室 qǐjūshì   living room	62
餐厅 cāntīng   dining room	64
厨房 chúfáng   kitchen	66
厨具 chújù   kitchenware	68
卧室 wòshì   bedroom	70
浴室 yùshì   bathroom	72
育婴室 yùyīngshì   nursery	74
洗衣间 xǐyījiān   utility room	76
工作间 gōngzuòjiān   workshop	78
工具箱 gōngjùxiāng toolbox	80
装修 zhuāngxiū   decorating	82
花园 huāyuán   garden	84
花园植物 huāyuánzhíwù garden plants	86
园艺工具 yuányì gōngjù garden tools	88
园艺 yuányì   gardening	90

## 服务 fúwù • services

急救 jíjiù emergency services	94
银行 yínháng   bank	96
通讯 tōngxùn communications	98
旅馆 lǚguǎn   hotel	100

## 购物 gòuwù • shopping

购物中心 gòuwùzhōngxīn shopping centre	104
百货商店 bǎihuò shāngdiàn	105

department store	
超级市场 chāojí shìchǎng supermarket	106
药店 yàodiàn   chemist	108
花店 huādiàn   florist	110
报刊亭 bàokāntíng newsagent	112
糖果店 tángguǒdiàn confectioner	113
其他店铺 qítā diànpù other shops	114

## 食物 shíwù • food

肉 ròu   meat	118
鱼 yú   fish	120
蔬菜 shūcài   vegetables	122
水果 shuǐguǒ   fruit	126
谷物及豆类 gǔwùjídòulèi grains and pulses	130
香草和香辛料 xiāngcǎo hé xiāngxīnliào   herbs and spices	132
瓶装食品 píngzhuāngshípǐn bottled foods	134
乳制品 rǔzhǐpǐn dairy produce	136
面包和面粉 miànbāo hé miànfěn   breads and flours	138
糕点 gāodiǎn cakes and desserts	140
熟食店 shúshídiàn delicatessen	142
饮料 yǐnliào   drinks	144

## 外出就餐 wàichū jiùcān • eating out

咖啡馆 kāfēiguǎn   café	148
酒吧 jiǔbā   bar	150
餐馆 cānguǎn   restaurant	152
快餐 kuàicān   fast food	154
早餐 zǎocān   breakfast	156
正餐 zhèngcān   dinner	158



**学习 xuéxí • study**

学校 xuéxiào   school	162
数学 shùxué   maths	164
科学 kēxué   science	166
高等院校 gāoděngyuànxìào college	168

**工作 gōngzuò • work**

办公室 bàngōngshì   office	172
计算机 jìsuànjī   computer	176
媒体 méitǐ   media	178
法律 fǎlǜ   law	180
农场 nóngchǎng   farm	182
建筑 jiànzhù   construction	186
职业 zhíyè   occupations	188

**交通运输 jiāotōng  
yùnsū • transport**

道路 dàolù   roads	194
公共汽车 gōnggòngqìchē bus	196
汽车 qìchē   car	198
摩托车 mótuōchē motorbike	204
自行车 zìxíngchē   bicycle	206
列车 lièchē   train	208
飞机 fēijī   aircraft	210
机场 jīchǎng   airport	212
船 chuán   ship	214
港口 gǎngkǒu   port	216

**体育运动 tǐyùyùndòng  
• sports**

美式橄榄球 měishì gǎnlǎnqiú American football	220
英式橄榄球 yīngshì gǎnlǎnqiú rugby	221
足球 zúqiú   soccer	222

曲棍类运动 qūgǔnlèi yùndòng hockey	224
板球 bǎnqiú   cricket	225
篮球 lánqiú   basketball	226
棒球 bàngqiú   baseball	228
网球 wǎngqiú   tennis	230
高尔夫球 gāo'ěrfūqiú golf	232
田径运动 tiánjìng yùndòng athletics	234
格斗运动 gédòu yùndòng combat sports	236
游泳 yóuyǒng   swimming	238
帆船运动 fānchuán yùndòng sailing	240
马上运动 mǎshàng yùndòng horse riding	242
钓鱼 diàoyú   fishing	244
滑雪 huáxuě   skiing	246
其他运动 qítāiyùndòng other sports	248
健身 jiànshēn   fitness	250

**休闲 xiūxián • leisure**

剧院 jùyuàn   theatre	254
乐队 yuèduì   orchestra	256
音乐会 yīnyuèhuì   concert	258
观光 guānguāng   sightseeing	260
户外活动 hùwàihuódòng outdoor activities	262
海滩 hǎitān   beach	264
露营 lùyíng   camping	266
家庭娱乐 jiātīngyúlè home entertainment	268
摄影 shèyǐng photography	270
游戏 yóuxì   games	272
工艺美术 gōngyīměishù arts and crafts	274

**环境 huánjìng  
• environment**

宇宙空间 yǔzhòukōngjiān space	280
地球 dìqiú   Earth	282
地貌 dìmào   landscape	284
天气 tiānqì   weather	286
岩石 yánshí   rocks	288
矿物 kuàngwù   minerals	289
动物 dòngwù   animals	290
植物 zhíwù   plants	296
城镇 chéngzhèn   town	298
建筑 jiànzhù   architecture	300

**日常便览 rìcháng  
biànlǎn • reference**

时间 shíjiān   time	304
日历 rìlì   calendar	306
数字 shùzì   numbers	308
度量衡 dùliáng Héng weights and measures	310
世界地图 shìjiè dìtú world map	312
小品词与反义词 xiǎopǐncí yǔ fǎnyící   particles and antonyms	320
常用语 cháng yòngyǔ useful phrases	322

# 词典介绍

图片的应用经研究有助于对信息的理解和记忆。本着这个原则，这本有着丰富图片注释的英中双语词典包含了范围很广的词汇。

这本词典按照情景划分章节，从饮食到健身，从家居到工作，从太空到动物世界，包括了日常生活的所有细节。从这本词典中你也可以找到额外的常用词汇和词组以便口语练习和词汇量的扩大。

这本词典实用，生动，易用。对所有对语言有兴趣的人来说是一个重要的参考工具。

## 注意事项

本词典中的中文汉字同中华人民共和国官方汉字一样为简体汉字。

本词典为普通话注音，注音标记为拼音。拼音是中国人和中文学生最熟悉的一种音标。四声的变化也在拼音的结构中显示。

所有词语项都是以同样的顺序展示 - 文字，拼音，英文。例如：

午餐	安全带
wǔcān	ānquándài
<b>lunch</b>	<b>seat belt</b>

动词在英文词尾以 (v) 作为标记。例如：

收获 shōuhuò | **harvest (v)**

所有词汇在书后也有总目录可以查阅。在总目录里你可以通过查询英文，或者查询拼音找到相应的页数。这样可以很顺利地找到和拼音或英文相对应的中文文字翻译。

# about the dictionary

The use of pictures is proven to aid understanding and the retention of information. Working on this principle, this highly-illustrated English-Chinese bilingual dictionary presents a large range of useful current vocabulary.

The dictionary is divided thematically and covers most aspects of the everyday world in detail, from the restaurant to the gym, the home to the workplace, outer space to the animal kingdom. You will also find additional words and phrases for conversational use and for extending your vocabulary.

This is an essential reference tool for anyone interested in languages – practical, stimulating, and easy-to-use.

## A few things to note

The Chinese in the dictionary is presented in simplified Chinese characters, as used in the People's Republic of China.

The pronunciation included for the Chinese is given in the Mandarin dialect and is shown in Pinyin, the standard romanization familiar to most native speakers and learners of Chinese. Accents showing the Chinese tones are included on the Pinyin.

The entries are always presented in the same order – Chinese, Pinyin, English – for example:

午餐	安全带
wǔcān	ānquándài
<b>lunch</b>	<b>seat belt</b>

Verbs are indicated by a (v) after the English, for example:

收获 shōuhuò | **harvest (v)**

Each language also has its own index at the back of the book. Here you can look up a word in either English or Pinyin and be referred to the page number(s) where it appears. To reference the Chinese characters for a particular word, look it up in the Pinyin or English index and then go to the page indicated.



# 使用说明

不论你学习语言的目的是工作，兴趣，为旅行做准备还是仅仅在已学语言的基础上扩大词汇量，这本词典都是你语言学习的重要工具。你可以多方面地去运用它。

在学习一种新的语言的时候，注意同源词汇（即在不同语言中相似的词汇）和衍生词汇（即只在某种语言中有相似根源的词汇）。你可以发现语言和语言之间的联系。例如说，英文从中文中引用了一些关于食品的词汇，而同时也输出了一些关于科技和流行文化的词汇。

## 实用技巧

- 当你设身处地在家，工作场所或者学校的时候，试着看相对应自己所在环境的章节。这样一来你可以合上书，环视四周看看自己可以识别多少事物。
- 为自己做一些词汇卡片，一面英文一面为中文和汉语拼音。时常携带这些卡片并且测试自己的记忆。记住每次测试之前要打乱卡片的顺序。
- 挑战自己尝试用某一页上的所有词汇写一个小故事，一封信或者一段对话。这样不但可以帮助你牢记这些词汇，而且可以帮助你记住它们的拼写。如果你想尝试写一篇长一点的文章，那么以至少含有2-3个词的句子为起点。
- 如果你有很强的视觉记忆，试着将书上的内容画出来或者在纸上诠释出来，然后合上书，在已有的图形下面填充词汇。
- 一旦你变得更加自信，从中文目录中任意找一些词汇，检查自己是否在翻阅到相关页之前能知道其词意。

# how to use this book

Whether you are learning a new language for business, pleasure, or in preparation for a holiday abroad, or are hoping to extend your vocabulary in an already familiar language, this dictionary is a valuable learning tool which you can use in a number of different ways.

When learning a new language, look out for cognates (words that are alike in different languages) and derivations (words that share a common root in a particular language). You can also see where the languages have influenced each other. For example, English has imported some terms for food from Chinese but, in turn, has exported some terms used in technology and popular culture.

## Practical learning activities

- As you move about your home, workplace, or college, try looking at the pages which cover that setting. You could then close the book, look around you and see how many of the objects and features you can name.
- Make flashcards for yourself with English on one side and Chinese/Pinyin on the other side. Carry the cards with you and test yourself frequently, making sure you shuffle them between each test.
- Challenge yourself to write a story, letter, or dialogue using as many of the terms on a particular page as possible. This will help you retain the vocabulary and remember the spelling. If you want to build up to writing a longer text, start with sentences incorporating 2-3 words.
- If you have a very visual memory, try drawing or tracing items from the book onto a piece of paper, then close the book and fill in the words below the picture.
- Once you are more confident, pick out words in the foreign language index and see if you know what they mean before turning to the relevant page to check if you were right.











人 rén  
people

# 人体 réntǐ • body

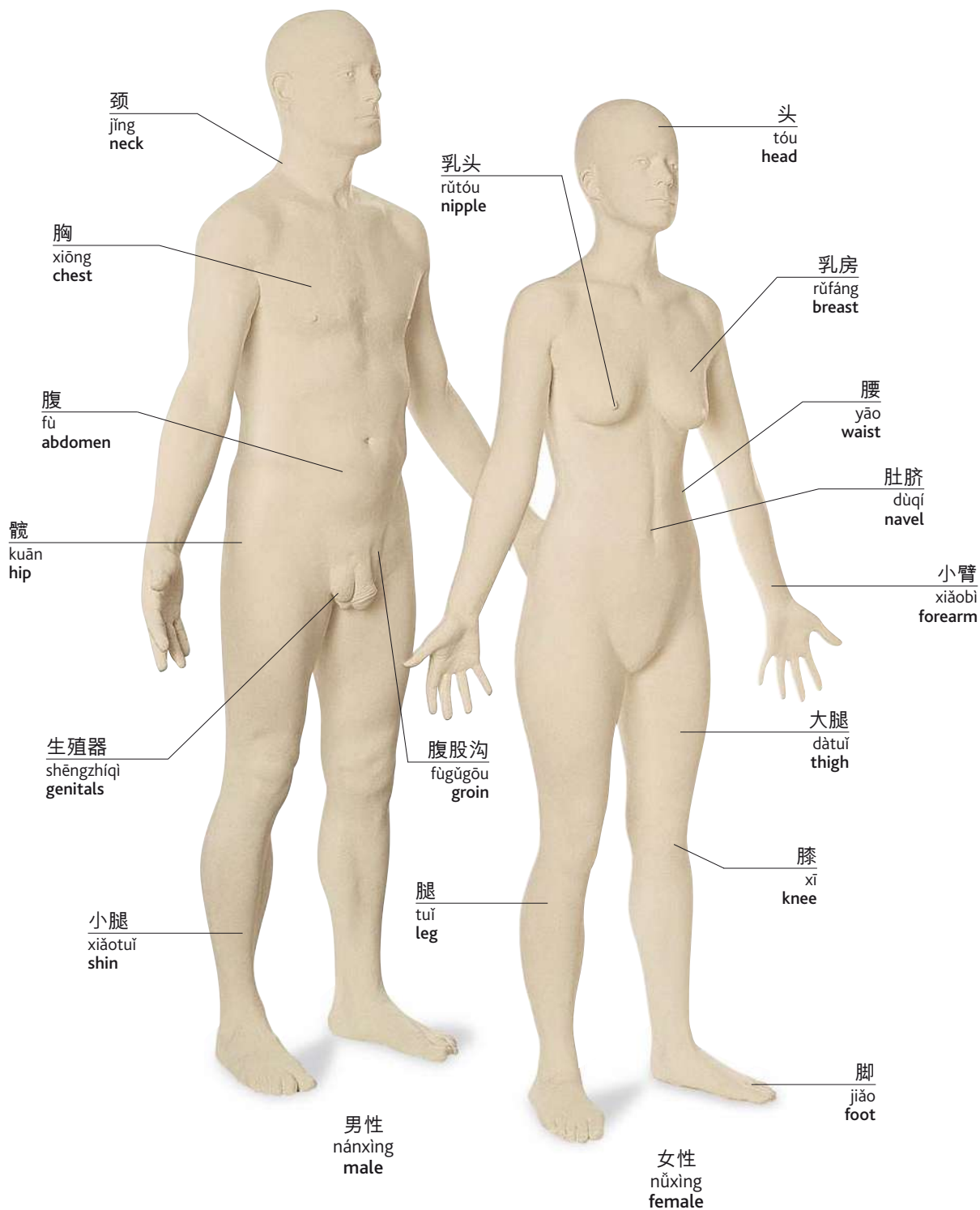



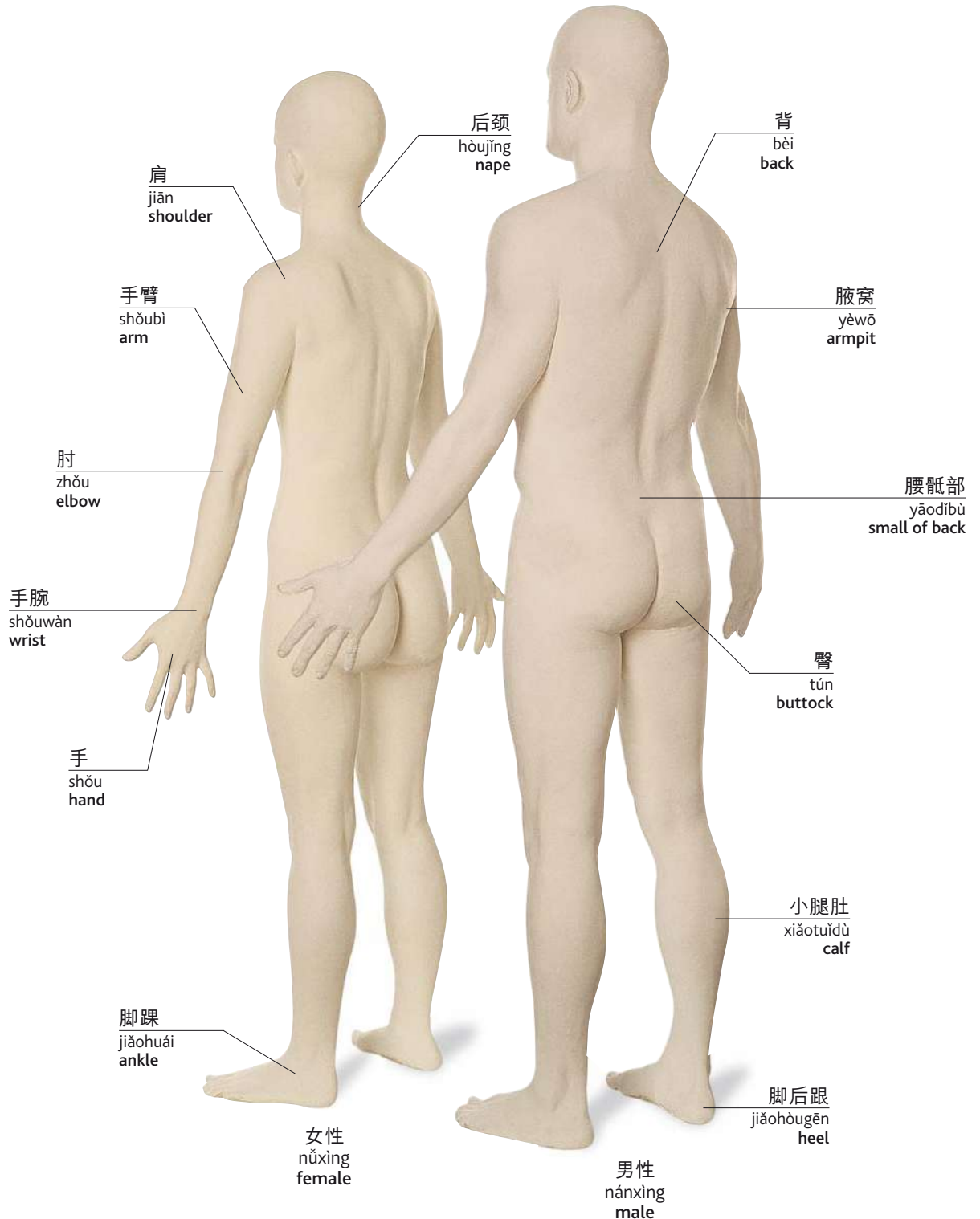

# 面部 miànbù • face

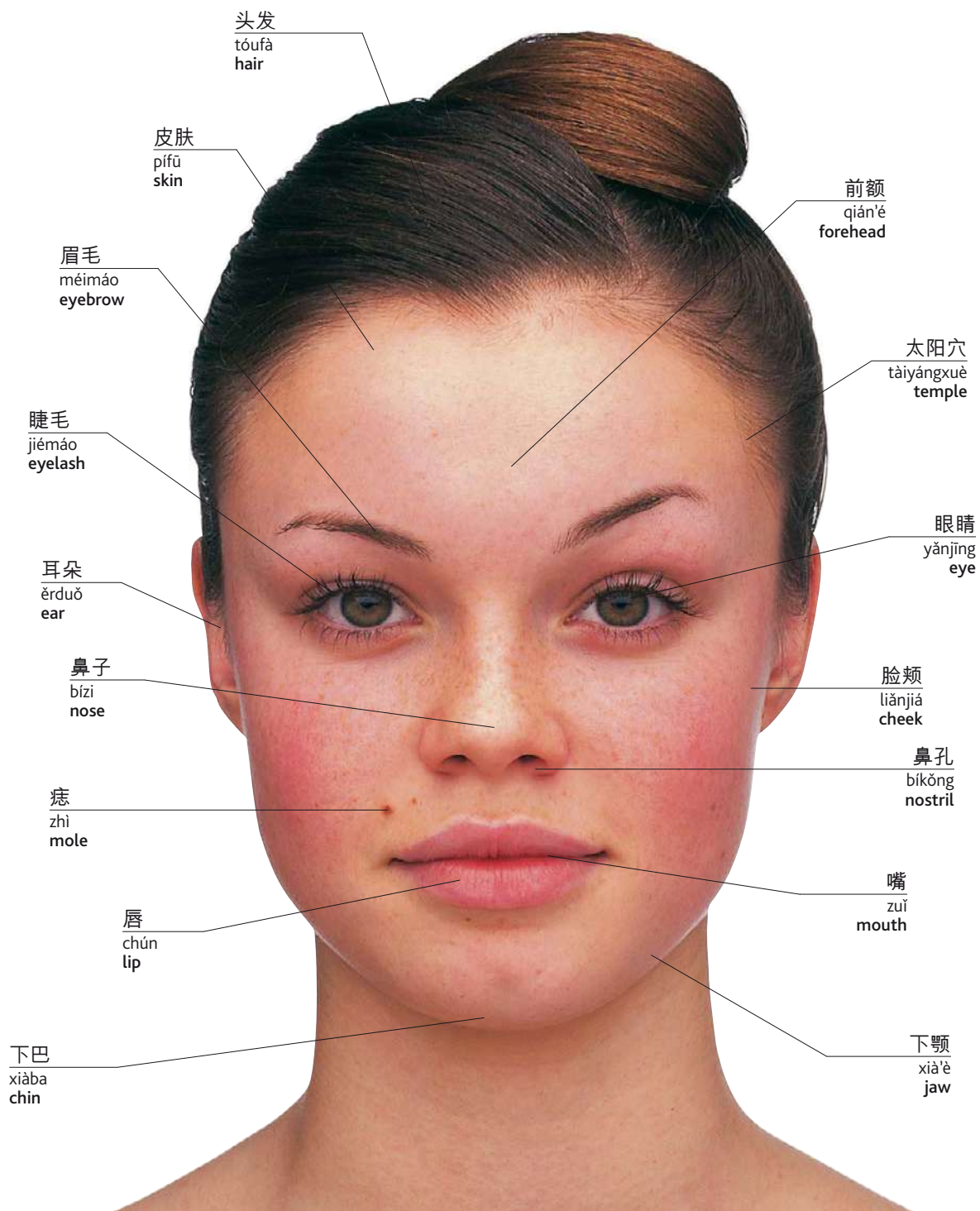



皱纹  
zhòuwén  
wrinkle



雀斑  
quèbān  
freckle



毛孔  
máokǒng  
pore



酒窝  
jiǔwō  
dimple

## 手 shǒu • hand

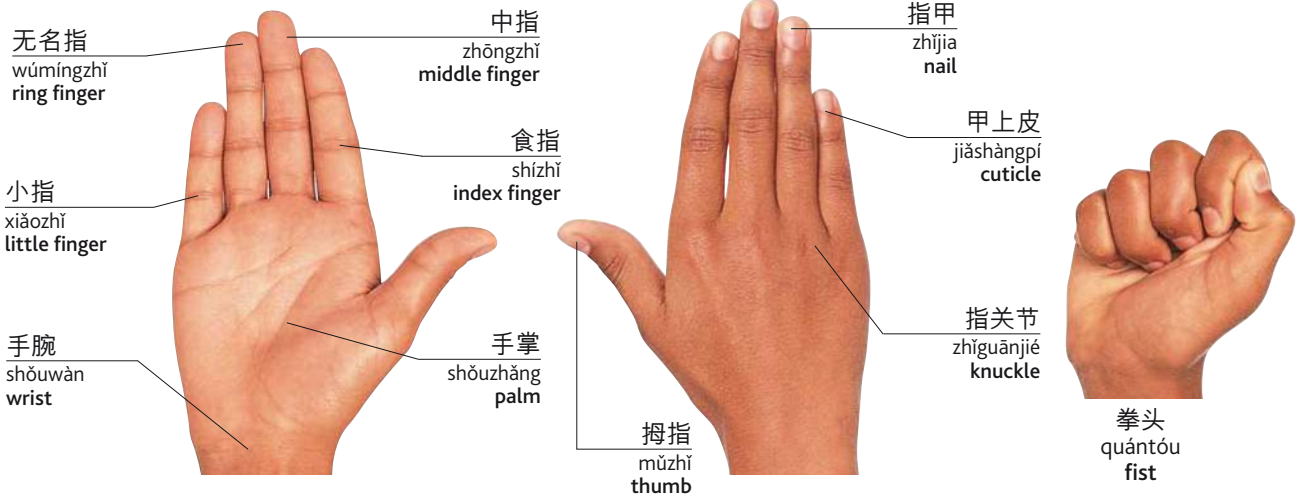

## 脚 jiǎo • foot

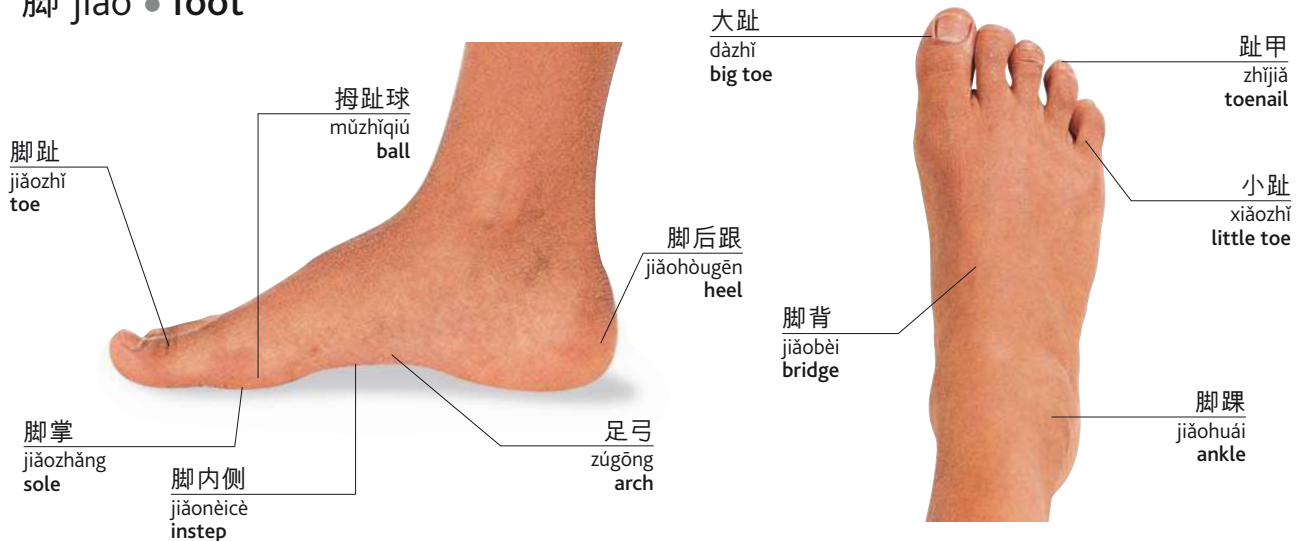





# 骨骼 gǔgé • skeleton

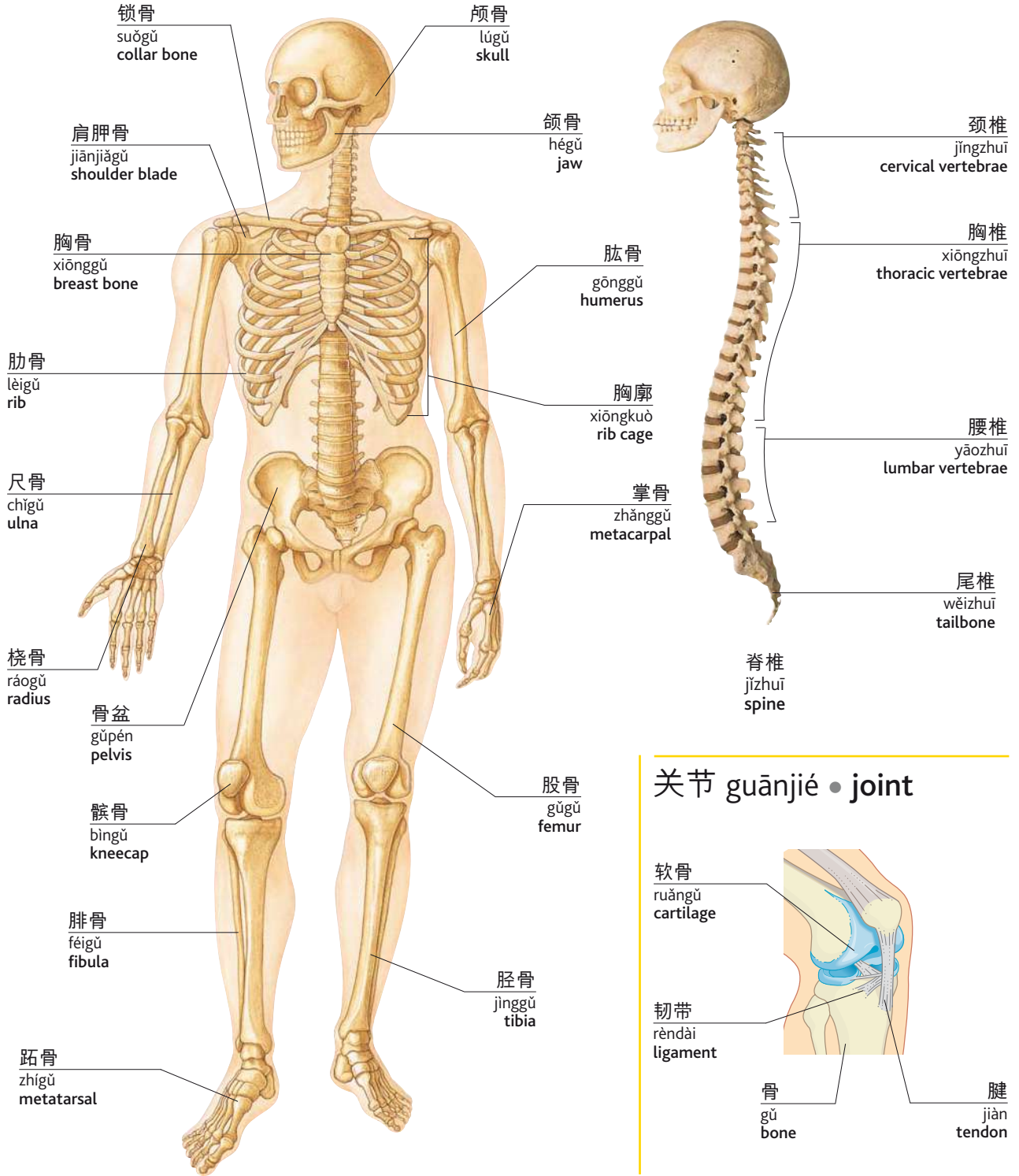

# 内脏 nèizàng • internal organs

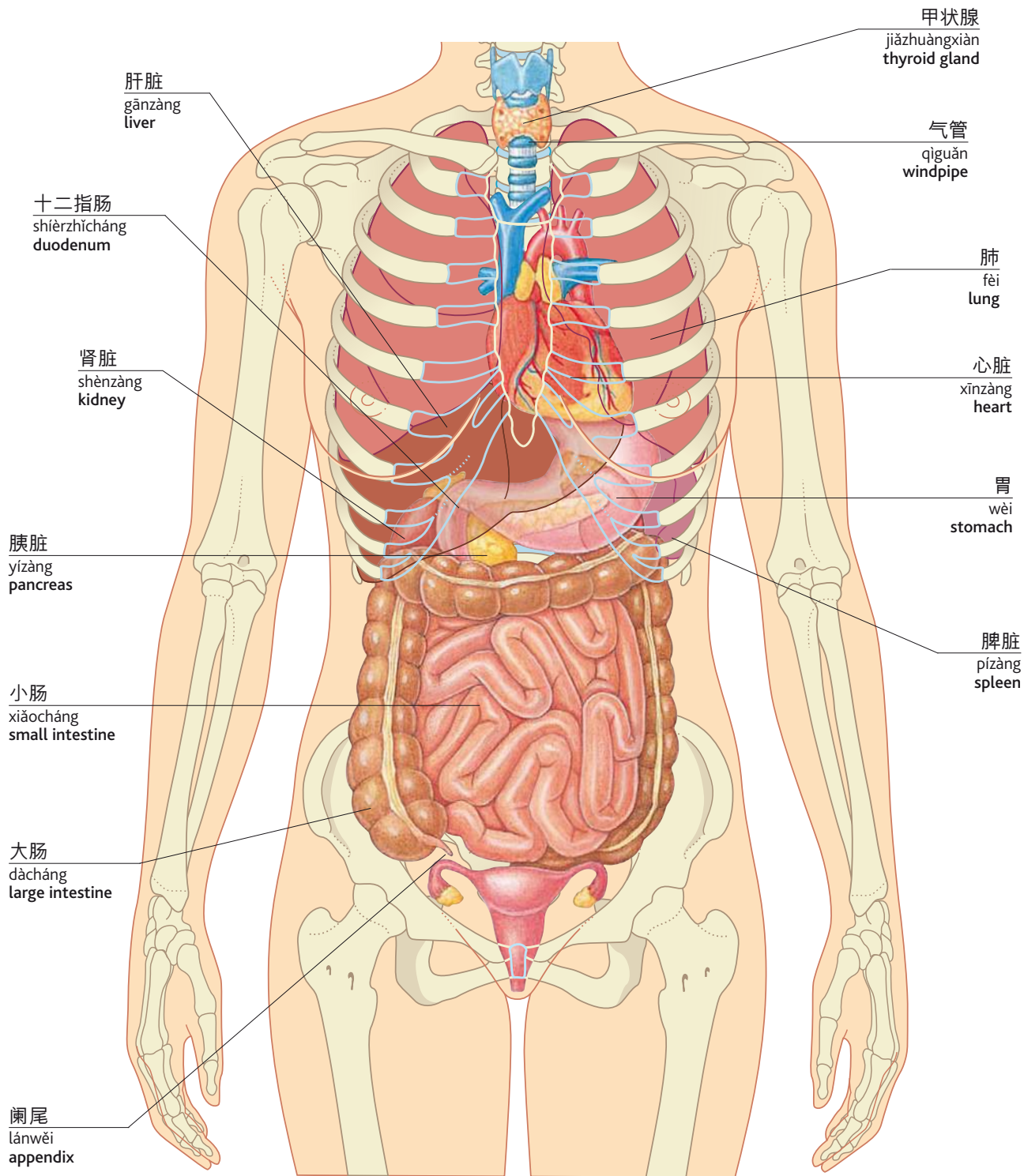



头部 tóubù • head

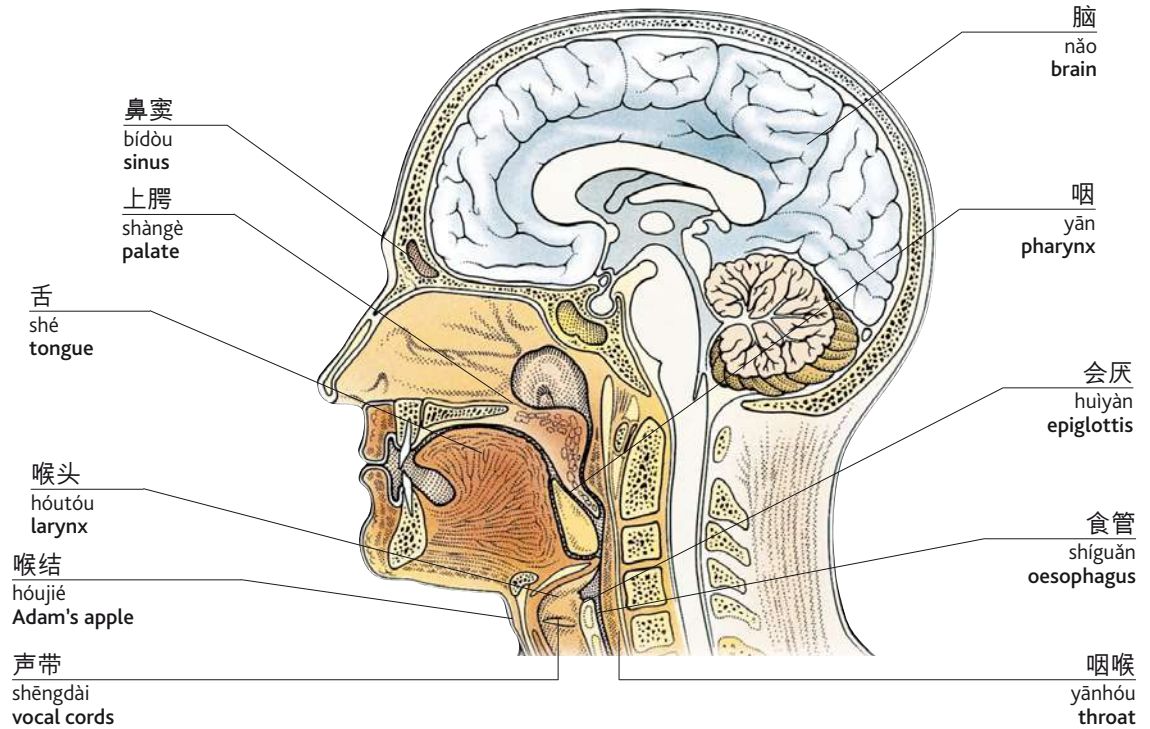

人体系统 réntǐxìtǒng • body systems

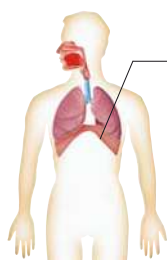

呼吸系统  
hūxìxìtǒng  
respiratory

横膈膜  
hénggémó  
diaphragm

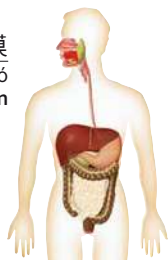

消化系统  
xiāohuàxìtǒng  
digestive

静脉  
jìngmài  
vein



心血管系统  
xīnxuèguǎnxìtǒng  
cardiovascular

动脉  
dòngmài  
artery

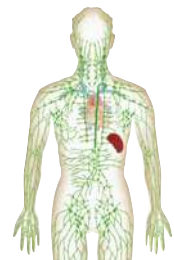

淋巴系统  
línbāxìtǒng  
lymphatic

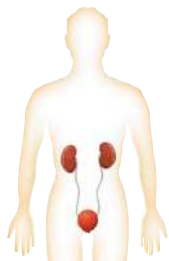

泌尿系统  
mìniào xìtǒng  
urinary

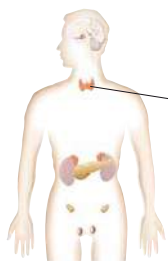

内分泌系统  
nèifēnmìxìtǒng  
endocrine

腺  
xiàn  
gland



神经系统  
shénjīngxìtǒng  
nervous

神经  
shénjīng  
nerve

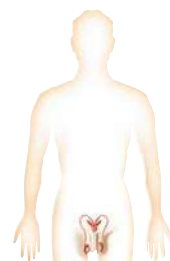

生殖系统  
shēngzhíxìtǒng  
reproductive

# 生殖器官 shēngzhíqìguān • reproductive organs

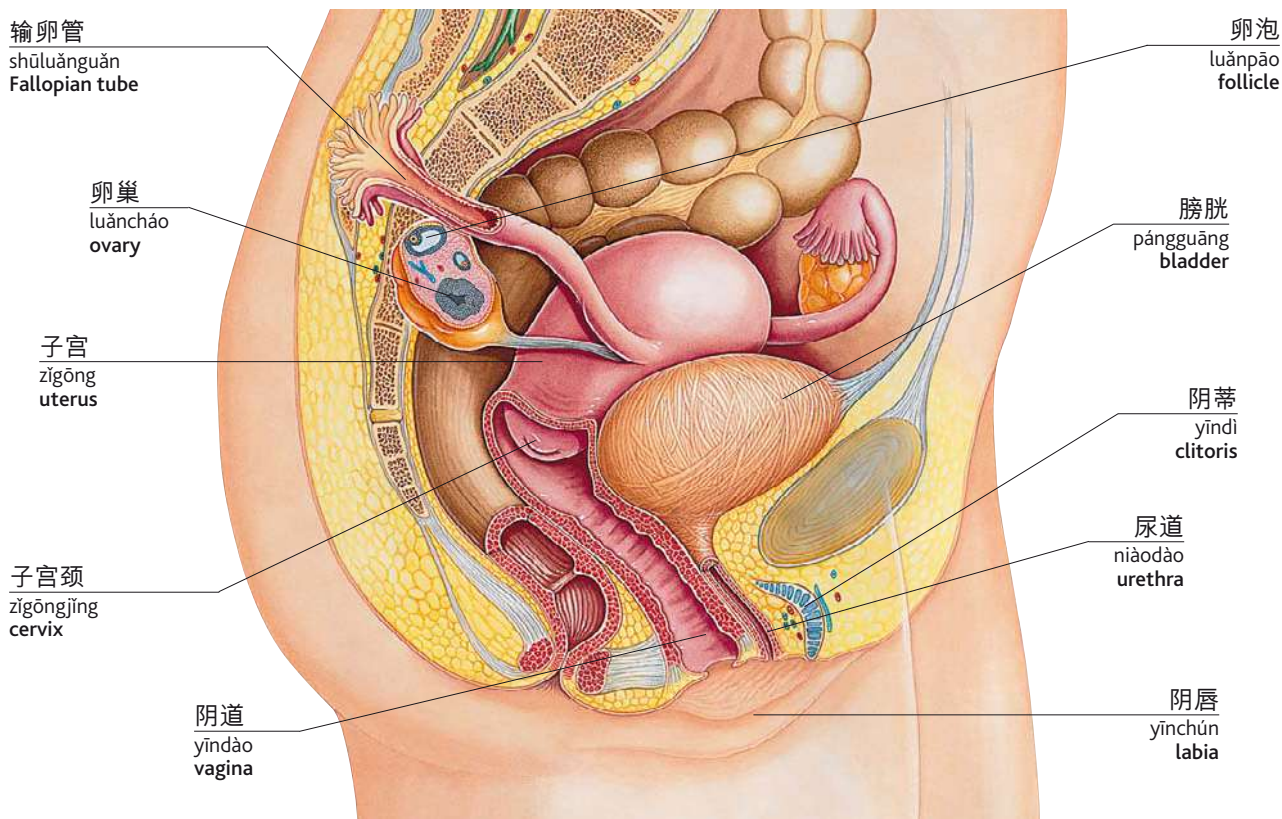

女性 nǚxìng | female

## 生殖 shēngzhí • reproduction

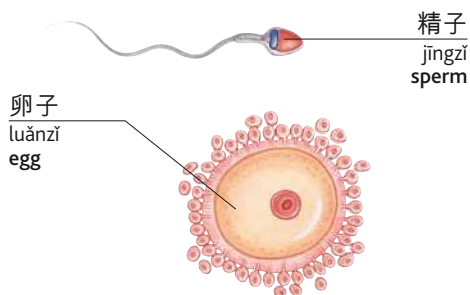

受精 shòujīng | fertilization

## 词汇 cíhuì • vocabulary

荷尔蒙 hé'ěrméng hormone	阳痿 yángwēi impotent	有生殖能力的 yǒushēngzhínénglìde fertile
排卵 páiluǎn ovulation	怀孕 huáiyùn conceive	月经 yuèjīng menstruation
不育 búyù infertile	性交 xìngjiāo intercourse	性病 xìngbìng sexually transmitted disease

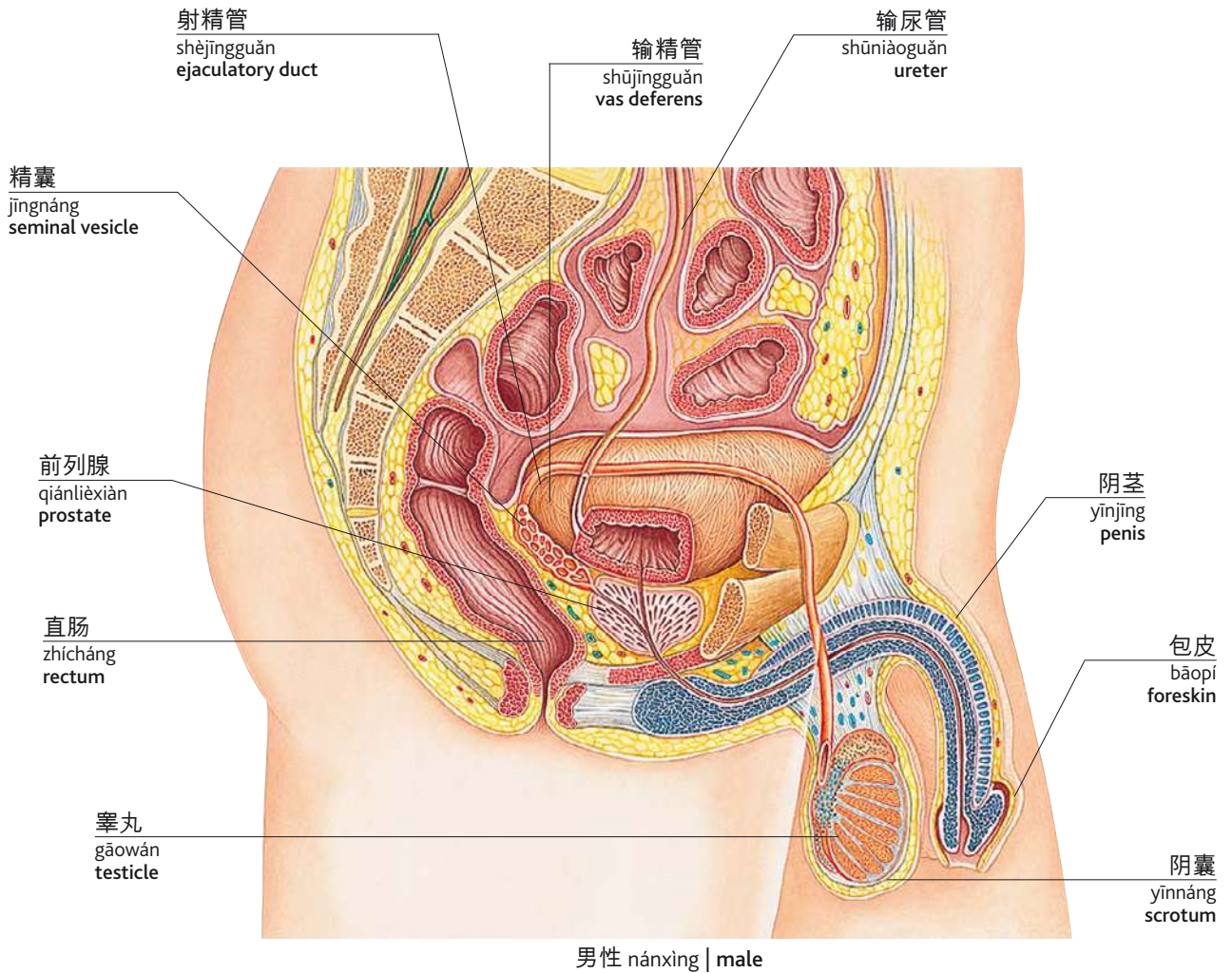

## 避孕 bìyùn • contraception





# 家庭 jiāting • family

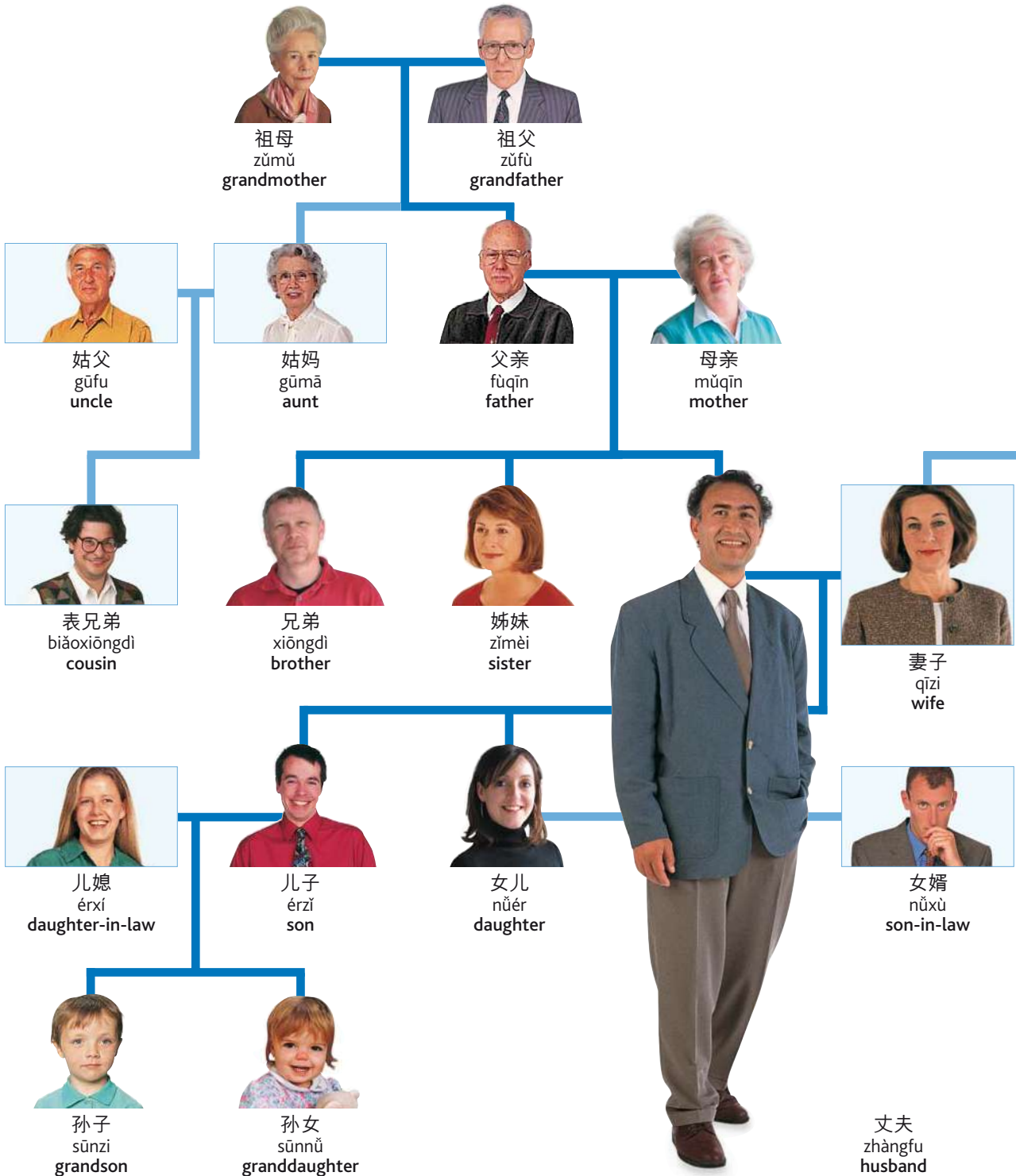

词汇 cíhuì • vocabulary

亲戚 qīnqi relatives	父母 fùmǔ parents	孙子女 / 外孙子女 sūnzǐnǚ / wàisūnzǐnǚ grandchildren	继母 jìmǔ stepmother	继子 jìzǐ stepson	配偶 pèiǒu partner
世代 shìdài generation	孩子 háizi children	祖父母 / 外祖父母 zǔfùmǔ / wàizǔfùmǔ grandparents	继父 jìfù stepfather	继女 jìnǚ stepdaughter	双胞胎 shuāngbāotāi twins



岳母  
yuèmǔ  
mother-in-law

岳父  
yuèfù  
father-in-law



妻妹(姐)夫  
qīmèi(jiě)fū  
brother-in-law

妻妹(姐)  
qīmèi(jiě)  
sister-in-law



外甥女  
wàishēngnǚ  
niece

外甥  
wàishēng  
nephew

太太  
tàitài  
Mrs

称谓 chēngwèi • titles

小姐  
xiǎojiě  
Miss

先生  
xiānshēng  
Mr



成长阶段 chéngzhǎngjiēduàn  
• stages



婴儿  
yīng'ér  
baby



儿童  
értóng  
child



男孩  
nánhái  
boy



女孩  
nǚhái  
girl



青少年  
qīngshàonián  
teenager



成年人  
chéngniánrén  
adult



男人  
nánrén  
man



女人  
nǚrén  
woman

# 人际关系 rénjìguānxì • relationships

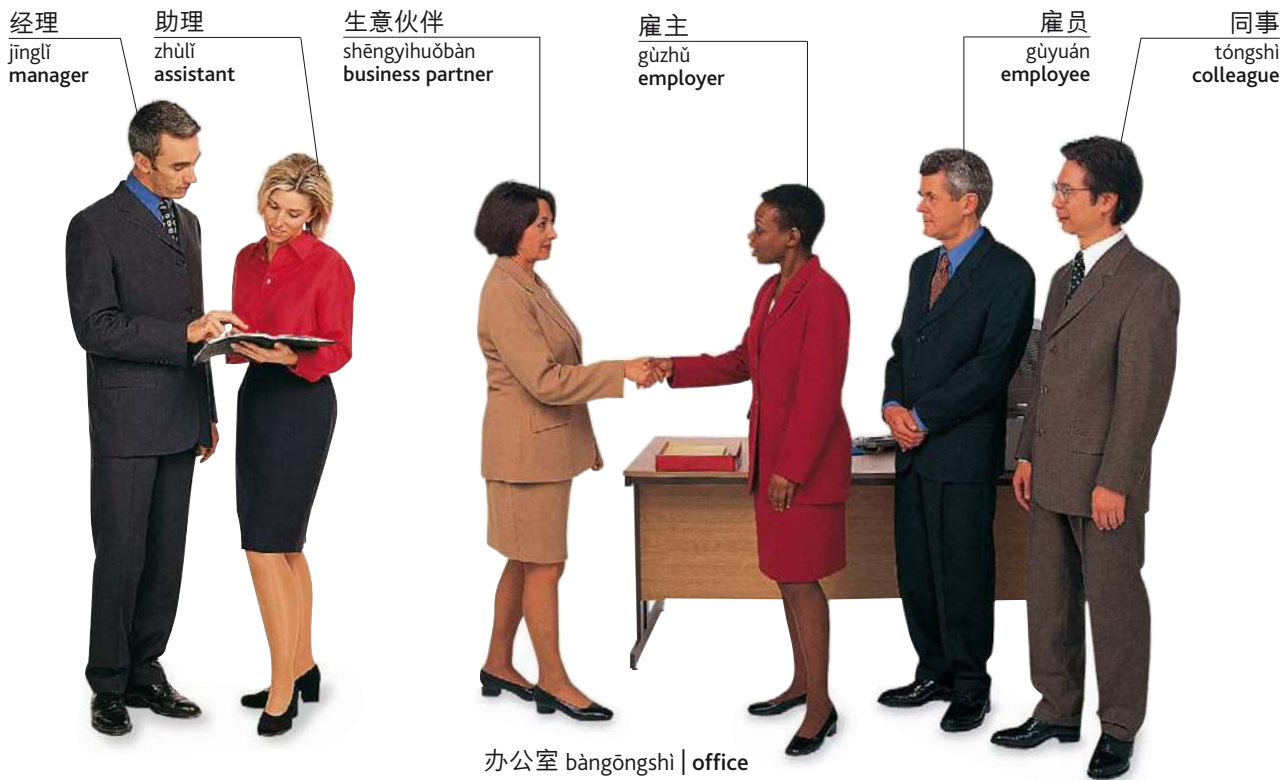

邻居 línjū neighbour



朋友 péngyǒu friend



熟人 shúrén acquaintance



笔友 bǐyǒu penfriend



男朋友 nán péngyǒu boyfriend

女朋友 nǚ péngyǒu girlfriend

情侣 qínglǚ | couple



未婚夫 wèihūnfū fiancé

未婚妻 wèihūnqī fiancée

未婚夫妻 wèihūnfūqī | engaged couple



## 情感 qínggǎn • emotions

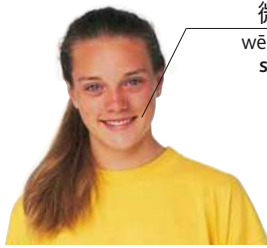

微笑  
wēixiào  
smile

快乐  
kuàilè  
happy



悲伤  
bēishāng  
sad



兴奋  
xīngfèn  
excited



无聊  
wúliáo  
bored



惊讶  
jīngyà  
surprised



惊恐  
jīngkǒng  
scared



愤怒  
fènnù  
angry



困惑  
kùnhuò  
confused



忧虑  
yōulǜ  
worried



紧张  
jǐnzhāng  
nervous



自豪  
zìháo  
proud



自信  
zìxìn  
confident



尴尬  
gāngà  
embarrassed



羞涩  
xiūsè  
shy

## 词汇 cíhuì • vocabulary

烦躁  
fánzào  
upset

笑  
xiào  
laugh (v)

叹息  
tànxi  
sigh (v)

叫喊  
jiàohǎn  
shout (v)

震惊  
zhènjīng  
shocked

哭  
kū  
cry (v)

晕倒  
yūndǎo  
faint (v)

打哈欠  
dǎhāqian  
yawn (v)

# 人生大事 rénshēngdàshì • life events



出生  
chūshēng  
be born (v)



入学  
rùxué  
start school (v)



交友  
jiāoyǒu  
make friends (v)



毕业  
bìyè  
graduate (v)



就业  
jiùyè  
get a job (v)



恋爱  
liàn'ài  
fall in love (v)



结婚  
jiéhūn  
get married (v)



生子  
shēngzǐ  
have a baby (v)



婚礼 hūnlǐ | wedding



离婚  
líhūn  
divorce



葬礼  
zànglǐ  
funeral

## 词汇 cíhuì • vocabulary

洗礼  
xǐlǐ  
christening

立遗嘱  
lìyǐzhǔ  
make a will (v)

纪念日  
jìniànrì  
anniversary

出生证明  
chūshēng zhèngmíng  
birth certificate

移民  
yímín  
emigrate (v)

婚宴  
hūnyàn  
wedding reception

退休  
tuìxiū  
retire (v)

蜜月  
mìyuè  
honeymoon

死亡  
sǐwáng  
die (v)

犹太男孩成人(13岁)仪式  
yóutài nánhái chéng rén  
(shísānsuì)yíshì  
bar mitzvah



节庆 jiéqìng • celebrations

生日聚会  
shēngrìjùhuì  
birthday party



生日  
shēngri  
birthday

贺卡  
hèkǎ  
card



礼物  
lǐwù  
present



圣诞节  
shèngdànjié  
Christmas

节日 jiérì  
• festivals



逾越节  
yúyuèjié  
Passover



新年  
xīnnián  
New Year



狂欢节 / 嘉年华会  
kuánghuānjié / jiā'niánhuáhuì  
carnival

游行  
yóuxíng  
procession



斋月  
zhāiyuè  
Ramadan

缎带  
duàndài  
ribbon



感恩节  
gǎn'ēnjié  
Thanksgiving



复活节  
fùhuójié  
Easter



万圣节  
wànshèngjié  
Halloween



排灯节  
páidēngjié  
Diwali









外表 wàibiǎo  
appearance



# 童装 tóngzhuāng • children's clothing

## 婴儿 yīng'ér • baby



背心  
bèixīn  
vest

摁扣  
ènkòu  
popper

婴儿连脚裤  
yīng'ér liánjiǎokù  
babygro



婴儿睡衣  
yīng'érshuìyī  
sleepsuit



儿童防雪装  
értóng fángxuězhuāng  
snowsuit



连衫裤  
liánshānkù  
romper suit



围嘴  
wéizǔi  
bib



婴儿手套  
yīng'érshǒutào  
mittens



婴儿鞋  
yīng'érxié  
booties



绒布尿布  
róngbù niàobù  
terry nappy



一次性尿布  
yícxìng niàobù  
disposable nappy



塑料尿裤  
sùliào niàokù  
plastic pants

## 幼儿 yòu'ér • toddler



遮阳帽  
zhēyángmào  
sunhat



围兜  
wéidōu  
apron



短裤  
duǎnkù  
shorts

工装裤  
gōngzhuāngkù  
dungarees



T恤衫  
Txùshān  
t-shirt



裙子  
qúnzi  
skirt



儿童 értóng • child



连衣裙  
liányīqún  
dress

风帽  
fēngmào  
hood

凉鞋  
liángxié  
sandals

夏天  
xiàtiān  
summer



雨衣  
yǔyī  
raincoat



牛仔裤  
niúzǎikù  
jeans

秋天  
qiūtiān  
autumn

背包  
bēibāo  
backpack

棒形纽扣  
bàng xíng niǔ kòu  
duffel coat



粗呢外套  
cūnī wàitào  
duffel coat



围巾  
wéijīn  
scarf

滑雪衫  
huáxuěshān  
anorak

长筒橡胶靴  
chángtǒng xiàngjiāoxuē  
wellington boots

冬天  
dōngtiān  
winter



室内便袍  
shì nèi biànpáo  
dressing gown

标识  
biāoshí  
logo

运动鞋  
yùndòngxié  
trainers

儿童睡衣  
értóng shuìyī  
nightie

拖鞋  
tuōxié  
slippers

睡衣  
shuìyī  
nightwear



足球球衣  
zúqiú qiúyī  
football strip



运动服  
yùndòngfú  
tracksuit



儿童保暖裤  
értóngbǎonuǎnkù  
leggings

词汇 cíhuì • vocabulary

天然纤维  
tiānrán xiānwéi  
natural fibre

合成的  
héchéngde  
synthetic

这可以机洗吗？  
zhèkěyǐ jīxǐ ma?  
Is it machine washable?

这适合两岁的孩子穿吗？  
zhè shìhé liǎngsuì de hái zǐ chuān ma?  
Will this fit a two-year-old?

# 男装 nánzhuāng • men's clothing



## 词汇 cíhuì • vocabulary

衬衫 chènshān  
shirt

晨衣 chényī  
dressing gown

运动服 yùndòngfú  
tracksuit

长 cháng  
long

羊毛衫 yángmáoshān  
cardigan

内衣裤 nèiyīkù  
underwear

雨衣 yǔyī  
raincoat

短 duǎn  
short

有没有大/小一点儿的尺寸?  
yǒuméiyǒu dà/xiǎo yìdiǎn de chǐcùn?  
Do you have this in a larger/smaller size?

我可以试穿一下吗?  
wǒ kěyǐ shìchuān yíxià ma?  
May I try this on?



休闲上衣  
xiūxián shàngyī  
blazer



粗呢夹克  
cūnījīákè  
sports jacket



马甲  
mǎjiǎ  
waistcoat

v型领  
Vxínglǐng  
v-neck

圆领  
yuánlǐng  
round neck

T恤衫  
Txùshān  
t-shirt



运动裤  
yùndòngkù  
sweatpants



滑雪衫  
huáxuěshān  
anorak



运动衫  
yùndòngshān  
sweatshirt



防风夹克  
fángfēngjiákè  
windcheater



套头毛衣  
tàotóumáoyī  
sweater



睡衣  
shuìyī  
pyjamas



背心  
bèixīn  
vest

便装  
biànzhuāng  
casual wear



短裤  
duǎnkù  
shorts



三角内裤  
sānjiǎonèikù  
briefs



短衬裤  
duǎnchèn kù  
boxer shorts



袜子  
wǎzi  
socks



# 女装 nǚzhuāng • women's clothing



女用内衣 nǚyòng nèiyī • lingerie



女用长睡衣  
nǚyòng cháng shuìyī  
negligée



衬裙  
chènqún  
slip

肩带  
jiāndài  
strap



紧身内衣  
jǐnshēn nèiyī  
camisole



女式短上衣  
nǚshì duǎnshàngyī  
basque

吊袜带  
diàowǎdài  
suspenders



长筒袜  
chángtǒngwǎ  
stockings



连裤袜  
liánkùwǎ  
tights

背心  
bèixīn  
vest



女用内裤  
nǚyòng nèikù  
knickers



胸罩  
xiōngzhào  
bra



女睡衣  
nǚshuìyī  
nightdress

婚礼 hūnlǐ • wedding



头纱  
tóushā  
veil

花边  
huābiān  
lace

花束  
huāshù  
bouquet

拖裾  
tuōjū  
train

结婚礼服  
jiéhūn lǐfú  
wedding dress

词汇 cíhuì • vocabulary

束腹  
shùfù  
corset

剪裁考究  
jiǎncái kǎojiū  
tailored

松紧袜带  
sōngjǐn wǎdài  
garter

露背装  
lòubèizhuāng  
halter neck

垫肩  
diànjiān  
shoulder pad

内有金属丝的(胸罩)  
nèiyǒu jīnshǔsīde (xiōngzhào)  
underwired

腰带  
yāodài  
waistband

运动胸罩  
yùndòng xiōngzhào  
sports bra

# 配饰 pèishì • accessories



帽子  
màozi  
cap



礼帽  
lǐmào  
hat



围巾  
wéijīn  
scarf



腰带扣  
yāodàikòu  
buckle

腰带  
yāodài  
belt

柄  
bǐng  
handle



尖  
jiān  
tip

伞  
sǎn  
umbrella



手帕  
shǒupà  
handkerchief



领结  
lǐngjié  
bow tie



领带夹  
lǐngdàijiā  
tie-pin



手套  
shǒutào  
gloves

# 首饰 shǒushi • jewellery



项链坠  
xiàngliànzhui  
pendant



胸针  
xiōngzhēn  
brooch



袖扣  
xiùkòu  
cufflink

珍珠项链  
zhēnzhū xiàngliàn  
string of pearls

链环  
liànhuán  
link



手镯  
shǒuzhuó  
bracelet

链扣  
liànkòu  
clasp



链子  
liànzi  
chain

耳环  
ěrhuán  
earring

戒指  
jièzhǐ  
ring

宝石  
bǎoshí  
stone

项链  
xiàngliàn  
necklace

手表  
shǒubiǎo  
watch



首饰盒 shǒushìhé | jewellery box



包 bāo • bags



钱夹  
qiánjiǎ  
wallet



钱包  
qiánbāo  
purse



挎包  
kuàbāo  
shoulder bag

扣环  
kòuhuán  
fastening

背带  
bēidài  
shoulder strap

提手  
tíshǒu  
handles



旅行袋  
lǚxíngdài  
holdall



公文包  
gōngwénbāo  
briefcase



手提包  
shòutibāo  
handbag



背包  
bēibāo  
backpack

鞋 xié • shoes

鞋眼  
xiéyǎn  
eyelet

鞋带  
xié dài  
lace

鞋舌  
xiéshé  
tongue

鞋底  
xiédǐ  
sole

鞋跟  
xiégēn  
heel



系带鞋  
xidàixié  
lace-up



步行靴  
bùxíngxuē  
walking boot



运动鞋  
yùndòngxié  
trainer



皮鞋  
píxié  
leather shoe



平底人字拖鞋  
píngdǐ rénzì tuōxié  
flip-flop



高跟鞋  
gāogēnxié  
high heel shoe



厚底鞋  
hòudǐxié  
platform shoe



凉鞋  
liángxié  
sandal



无带便鞋  
wúdài biànxué  
slip-on



镂花皮鞋  
lòuhuā píxié  
brogue

# 头发 tóufà • hair



发梳  
fāshū  
comb

梳头  
shūtóu  
comb (v)



发刷  
fāshuā  
brush

刷头发 shuātóufà | brush (v)



冲洗  
chōngxǐ  
rinse (v)



美发师  
měifāshī  
hairdresser

洗头盆  
xītóupén  
sink

顾客  
gùkè  
client

洗 xǐ | wash (v)



罩衫  
zhàoshān  
robe

剪  
jiǎn  
cut (v)



吹干  
chuīgān  
blow dry (v)



定型  
dìngxíng  
set (v)

## 美发用品 měifà yòngpǐn • accessories



吹风机  
chuīfēngjī  
hairdryer



洗发水  
xǐfāshuǐ  
shampoo



护发素  
hùfàsù  
conditioner



发胶  
fàjiāo  
gel



定型水  
dìngxíngshuǐ  
hairspray



剪刀  
jiǎndāo  
scissors



发箍  
fàgū  
hairband

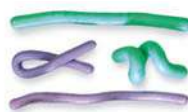

卷发夹子  
juǎnfà jiāzi  
curler



发卡  
fàqiǎ  
hairpin

## 发型 fàxíng • styles



马尾辫  
mǎwěibiàn  
ponytail

丝带  
sīdài  
ribbon



麻花辫  
máhuābiàn  
plait



法式盘头  
fǎshì pántóu  
french pleat



发髻  
fàjì  
bun



小辫  
xiǎobiàn  
pigtails



女式短发  
nǚshì duǎnfǎ  
bob



短发  
duǎnfǎ  
crop



卷发  
juǎnfǎ  
curly



烫发  
tàngfǎ  
perm



直发  
zhífǎ  
straight



挑染  
tiāorǎn  
highlights

发根  
fāgēn  
roots



秃顶  
tūdǐng  
bald



假发  
jiǎfǎ  
wig

## 发色 fàsè • colours



金色  
jīnsè  
blonde



深褐色  
shēnhèsè  
brunette



红褐色  
hónghèsè  
auburn



红棕色  
hóngzōngsè  
ginger



黑色  
hēisè  
black



灰色  
huīsè  
grey



白色  
báisè  
white



染色的  
rǎnsède  
dyed

## 词汇 cíhuì • vocabulary

修剪  
xiūjiǎn  
trim (v)

拉直  
lāzhí  
straighten (v)

理发师  
lǐfàshī  
barber

头皮屑  
tóupíxiè  
dandruff

发梢分叉  
fàshāo fēnchā  
split ends

油性(发质)  
yóuxìng (fàzhì)  
greasy

干性(发质)  
gānxìng (fàzhì)  
dry

中性(发质)  
zhōngxìng (fàzhì)  
normal

头皮  
tóupí  
scalp

发带  
fàdài  
hairtie



# 美容 měiróng • beauty



染发剂  
rǎnfàjì  
hair dye

眼影  
yǎnyǐng  
eye shadow

睫毛膏  
jiémáogāo  
mascara

眼线液  
yǎnxiànyè  
eyeliner

腮红  
sāihóng  
blusher

粉底  
fēndǐ  
foundation

口红  
kǒuhóng  
lipstick

## 化妆 huàzhuāng • make-up



眉笔  
méibǐ  
eyebrow pencil



眉刷  
méishuā  
eyebrow brush



眉夹  
méijiā  
tweezers



唇彩  
chúncǎi  
lip gloss



唇刷  
chúnshuā  
lip brush



唇线笔  
chúnxiànbǐ  
lip liner



化妆刷  
huàzhuāngshuā  
brush



遮瑕膏  
zhēxiágāo  
concealer

化妆镜  
huàzhuāngjìng  
mirror

粉饼  
fēnbǐng  
face powder

粉扑  
fēnpū  
powder puff



粉盒 fēnhé | compact

## 美容护理 měirónghùlǐ • beauty treatments



面膜  
miànmó  
face pack

紫外线浴床  
zǐwàixiàn yùchuáng  
sunbed

面部护理  
miàn bù hù lǐ  
facial

去死皮  
qù sǐ pí  
exfoliate (v)

热蜡脱毛  
rèlàtuōmáo  
wax

趾甲护理  
zhǐjiǎ hùlǐ  
pedicure

## 指甲护理 zhǐjiǎ hùlǐ • manicure



洗甲水  
xǐjiǎshuǐ  
nail varnish remover

指甲油  
zhǐjiǎyóu  
nail varnish

指甲锉  
zhǐjiǎcuò  
nail file

指甲剪  
zhǐjiǎjiǎn  
nail scissors

指甲刀  
zhǐjiǎdāo  
nail clippers

## 化妆用品 huàzhuāng yòngpǐn • toiletries



洁面水  
jiémiànshuǐ  
cleanser

爽肤水  
shuǎngfūshuǐ  
toner

保湿霜  
bǎoshīshuāng  
moisturizer

黑肤霜  
hēifūshuāng  
self-tanning cream

香水  
xiāngshuǐ  
perfume

淡香水  
dànxiāngshuǐ  
eau de toilette

## 词汇 cíhuì • vocabulary

肤色  
fū sè  
complexion

油性(皮肤)  
yóu xìng (pí fū)  
oily

棕褐色皮肤  
zōng hē sè pí fū  
tan

皮肤白皙  
pí fū bái xī  
fair

敏感性的  
mǐn gǎn xìng de  
sensitive

纹身  
wén shēn  
tattoo

肤色较深  
fū sè jiào shēn  
dark

低变应原的  
dī biàn yīng yuán de  
hypoallergenic

抗皱  
kàng zhòu  
anti-wrinkle

干性(皮肤)  
gān xìng (pí fū)  
dry

色调  
sè diào  
shade

棉球  
mián qiú  
cotton balls









健康 jiànkāng  
health





# 疾病 jíbìng • illness



发烧 fāshāo | fever



头痛  
tóutòng  
headache



鼻血  
bíxiě  
nosebleed



咳嗽  
késou  
cough

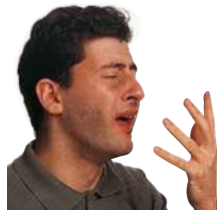

喷嚏  
pēntǐ  
sneeze



感冒  
gǎnmào  
cold



流感  
liúgǎn  
flu



气雾剂  
qìwùjì  
inhaler

哮喘  
xiàochuǎn  
asthma



痉挛  
jìngluán  
cramps



恶心  
ěxīn  
nausea



水痘  
shuǐdòu  
chickenpox



皮疹  
pízhěn  
rash

## 词汇 cíhuì • vocabulary

中风  
zhòngfēng  
stroke

糖尿病  
tángniàobìng  
diabetes

湿疹  
shīzhěn  
eczema

寒战  
hánzhàn  
chill

呕吐  
ǒutù  
vomit (v)

腹泻  
fùxiè  
diarrhoea

血压  
xuèyā  
blood pressure

过敏  
guòmǐn  
allergy

传染  
chuánrǎn  
infection

胃痛  
wèitòng  
stomach ache

癫痫  
diānxián  
epilepsy

麻疹  
mázhěn  
measles

心肌梗塞  
xīnjī gēngsè  
heart attack

枯草热  
kūcǎorè  
hayfever

病毒  
bìngdú  
virus

昏厥  
hūnjué  
faint (v)

偏头痛  
piāntóutòng  
migraine

腮腺炎  
sāixiànyán  
mumps

# 医生 yīshēng • doctor

## 诊断 zhěnduàn • consultation

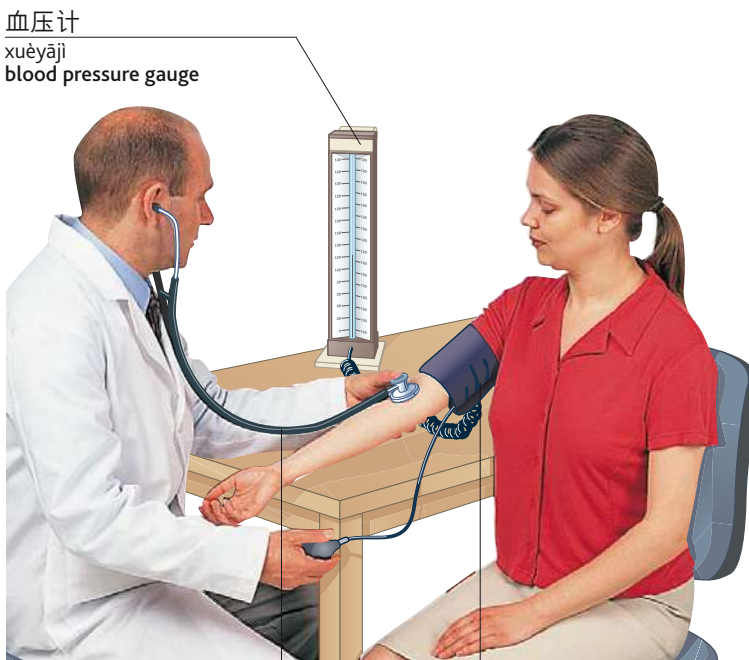
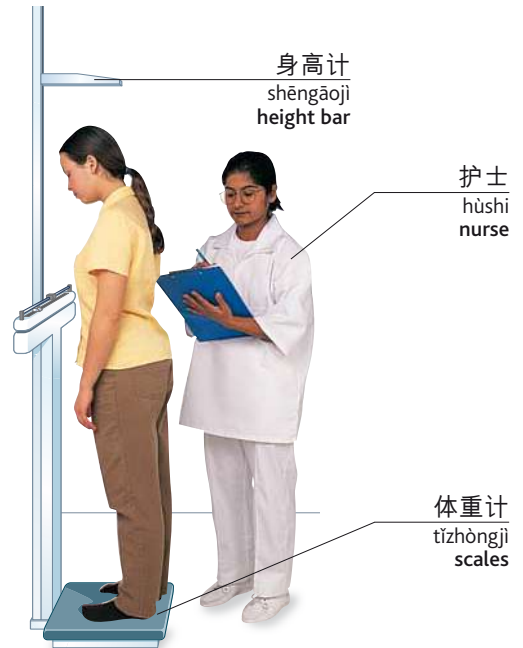
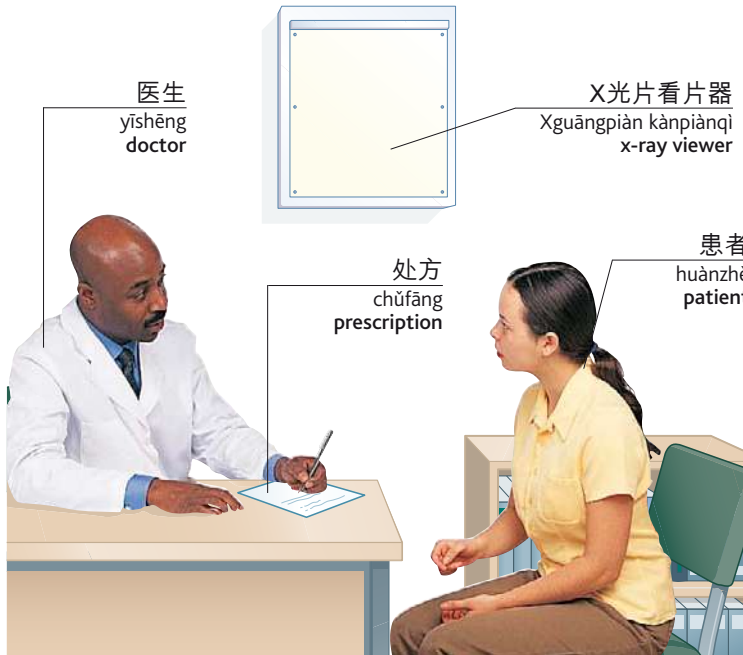

### 词汇 cíhuì • vocabulary

预约 yùyuē appointment

接种 jiēzhòng inoculation

诊疗室 zhěnliaoshì surgery

体温计 tǐwēnjì thermometer

候诊室 hòuzhěnsì waiting room

体检 tǐjiǎn medical examination

我需要看医生。  
wǒ xūyào kànyīshēng.  
I need to see a doctor.

这儿疼。  
zhè'ér téng.  
It hurts here.



# 创伤 chuāngshāng • injury



扭伤 niǔshāng | sprain

医用吊带  
yīyòng  
diàodài  
sling



骨折  
gǔzhé  
fracture

颈托  
jǐngtuō  
neck brace



头颈部损伤  
tóujǐngbù sùnshāng  
whiplash



割伤  
gēshāng  
cut



擦伤  
cāshāng  
graze



淤伤  
yūshāng  
bruise



刺伤  
cìshāng  
splinter



晒伤  
shàishāng  
sunburn



烧伤  
shāoshāng  
burn



咬伤  
yǎoshāng  
bite



蜇伤  
zhēshāng  
sting

## 词汇 cíhuì • vocabulary

事故  
shìgù  
accident

大出血  
dàchūxuè  
haemorrhage

中毒  
zhòngdú  
poisoning

他/她没事吧?  
tā/tā méishi ba?  
Will he/she be all right?

紧急情况  
jǐnjí qíngkuàng  
emergency

水泡  
shuǐpào  
blister

电击  
diànjī  
electric shock

哪里疼?  
nǎlǐ téng?  
Where does it hurt?

伤口  
shāngkǒu  
wound

脑震荡  
nǎozhèndàng  
concussion

头部损伤  
tóubù sùnshāng  
head injury

请叫救护车。  
qǐngjiào jiùhùchē。  
Please call an ambulance.

# 急救 jíjiù • first aid

药膏  
yàogāo  
ointment

创可贴  
chuàngkětīe  
plaster

安全别针  
ānquán biézhēn  
safety pin

绷带  
bēngdài  
bandage

止痛药  
zhītòngyào  
painkillers



消毒湿巾  
xiāodú shījīn  
antiseptic wipe

镊子  
nièzi  
tweezers

剪刀  
jiǎndāo  
scissors

消毒剂  
xiāodújī  
antiseptic

急救箱 jíjiùxiāng | first aid box

纱布  
shābù  
gauze



包扎  
bāozā  
dressing



医用夹板 yīyòngjiābǎn | splint



橡皮膏  
xiàngpígāo  
adhesive tape



复苏术  
fùsūshù  
resuscitation

## 词汇 cíhuì • vocabulary

休克  
xiūkè  
shock

脉搏  
màibó  
pulse

窒息  
zhìxī  
choke (v)

您能帮帮我吗?  
nín néng bāngbāng wǒ ma?  
Can you help?

不省人事  
bùxǐng rénshi  
unconscious

呼吸  
hūxī  
breathing

无菌  
wújūn  
sterile

你会急救吗?  
nǐ huì jíjiù ma?  
Do you know first aid?

# 医院 yīyuàn • hospital



验血 yànxuè  
blood test



注射 zhùshè  
injection

移动病床 yídòng bìngchuáng  
trolley



急诊室 jízhěnshì  
emergency room

呼叫按钮 hūjiào ànniǔ  
call button



病房 bìngfáng  
ward



轮椅 lúnǚ  
wheelchair



X光 Xguāng  
x-ray

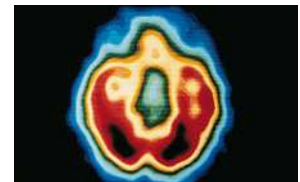

CT扫描 CT sǎomiào  
scan

## 词汇 cíhuì • vocabulary

手术 shǒushù  
operation

出院 chūyuàn  
discharged

探视时间 tànsì shíjiān  
visiting hours

儿童病房 értóng bìngfáng  
children's ward

加护病房 jiāhù bìngfáng  
intensive care unit

收治的 shōuzhìde  
admitted

诊所 zhěnsuǒ  
clinic

产科病房 chǎnkē bìngfáng  
maternity ward

单人病房 dānrén bìngfáng  
private room

门诊病人 ménzhěn bìnggrén  
outpatient



## 科室 kēshì • departments



耳鼻喉科  
ěrbíhóukē  
ENT



心脏病科  
xīnzàngbīngkē  
cardiology



整形外科  
zhěngxíngwàikē  
orthopaedy



妇科  
fùkē  
gynaecology



理疗科  
lǐliáokē  
physiotherapy



皮肤科  
pífukē  
dermatology



儿科  
érkē  
paediatrics



放射科  
fàngshèkē  
radiology



外科  
wàikē  
surgery



产科  
chǎnkē  
maternity



精神科  
jīngshénkē  
psychiatry



眼科  
yǎnkē  
ophthalmology

## 词汇 cíhuì • vocabulary

神经科  
shénjīngkē  
neurology

泌尿科  
mìniàokē  
urology

内分泌科  
nèifēnmìkē  
endocrinology

病理科  
bīnglǐkē  
pathology

结果  
jiéguǒ  
result

肿瘤科  
zhǒngliúkē  
oncology

矫形外科  
jiǎoxíngwàikē  
plastic surgery

转诊  
zhuǎnzhěn  
referral

检查  
jiǎnchá  
test

专科医生  
zhuānkē yīshēng  
consultant

# 牙医 yáyī • dentist

## 牙齿 yáchǐ • tooth

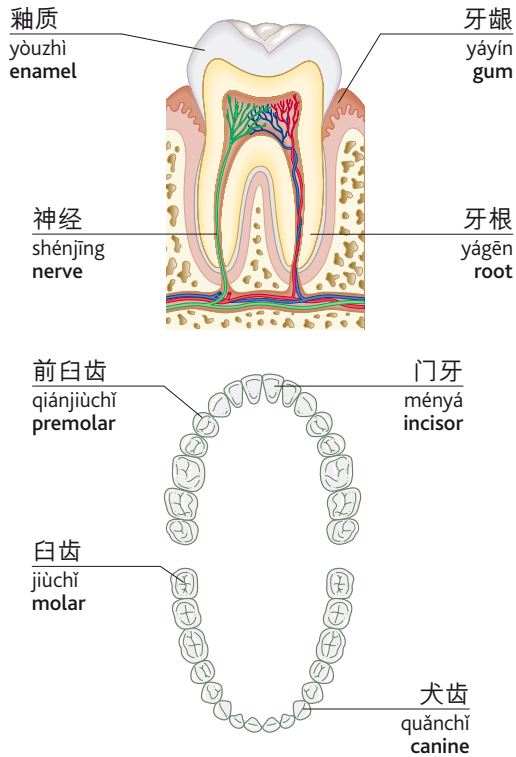

## 检查 jiǎnchá • check-up



### 词汇 cíhuì • vocabulary

牙痛 yátòng toothache	牙钻 yázuàn drill
牙菌斑 yájūnbān plaque	牙线 yáxiàn dental floss
龋齿 qǔchǐ decay	拔牙 báiyá extraction
填充物 tiánchōngwù filling	齿冠 chǐguān crown



用牙线洁齿 yòng yáxiàn jiéchǐ floss (v)



刷牙 shuāyá brush



畸齿矫正器 jǐchǐ jiàozhèngqì brace



口腔光 kǒuqiānguāng dental x-ray



牙片 yápiàn x-ray film



假牙 jiǎyá dentures

# 配镜师 pèijìngshī • optician



视力检查 shìlì jiǎnchá | eye test

眼镜盒  
yǎnjìng hé  
case



眼镜  
yǎnjìng  
glasses

镜片  
jìngpiàn  
lens



太阳镜  
tàiyángjìng  
sunglasses

镜架  
jìngjià  
frame

清洁液  
qīngjiéyè  
cleaning fluid



消毒液  
xiāodúyè  
disinfectant solution



隐形眼镜盒  
yǐnxíng yǎnjìng hé  
lens case

隐形眼镜 yǐnxíng yǎnjìng | contact lenses

# 眼睛 yǎnjīng • eye

眉毛  
méimáo  
eyebrow

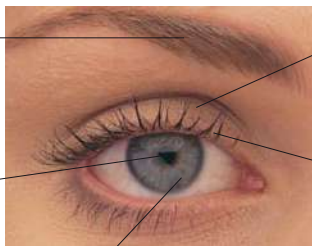

眼睑  
yǎnjiǎn  
eyelid

瞳孔  
tóngkǒng  
pupil

眉毛  
méimáo  
eyelash

虹膜  
hóngmó  
iris

视网膜  
shìwǎngmó  
retina

晶状体  
jīngzhuàngtǐ  
lens

角膜  
jiǎomó  
cornea

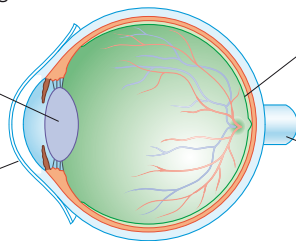

视神经  
shìshénjīng  
optic nerve

# 词汇 cíhuì • vocabulary

视力  
shìlì  
vision

散光  
sǎnguāng  
astigmatism

屈光度  
qūguāngdù  
diopter

远视  
yuǎnshì  
long sight

眼泪  
yǎnlèi  
tear

近视  
jìnshì  
short sight

白内障  
báinèizhàng  
cataract

双光的  
shuāngguāngde  
bifocal



# 怀孕 huáiyùn • pregnancy

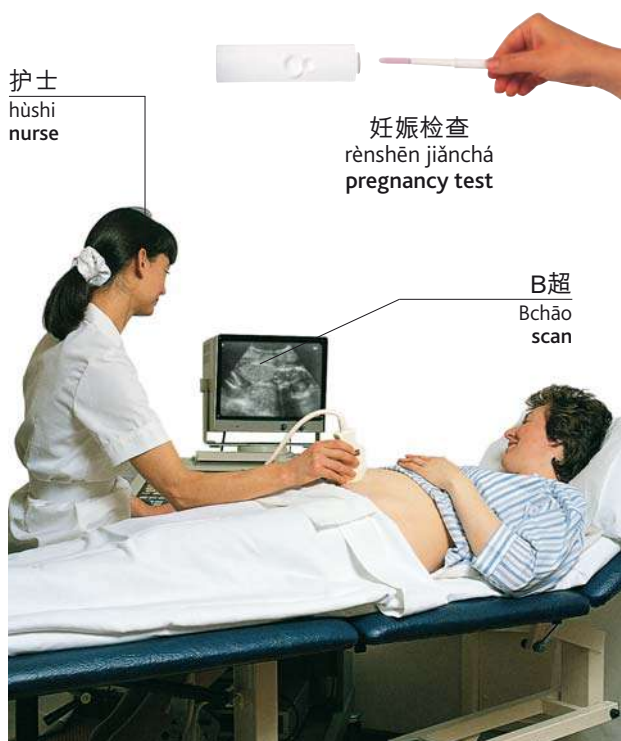

超声波(检查) chāoshēngbō(jiǎnchá) | ultrasound

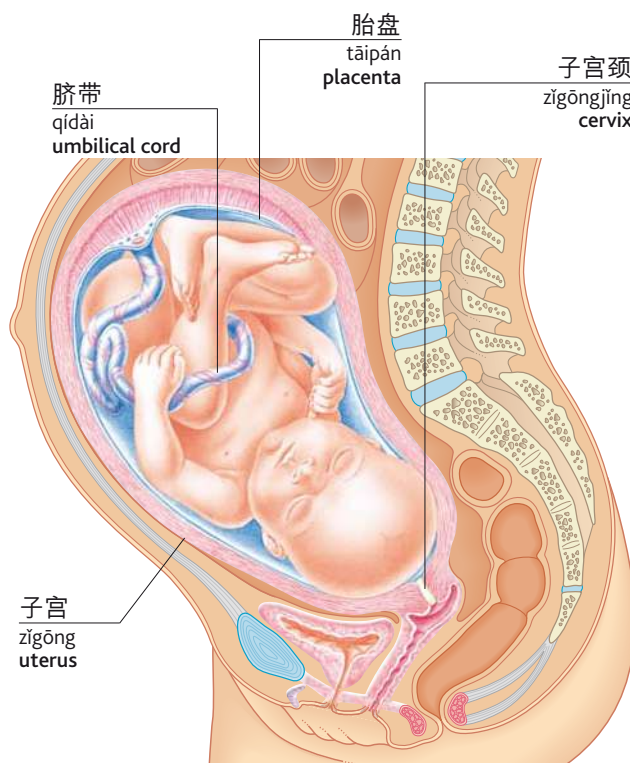

胎儿 tāi'ér | foetus

## 词汇 cíhuì • vocabulary

排卵 páiluǎn ovulation

出生前 chūshēngqián antenatal

宫缩 gōngsuō contraction

扩张术 kuòzhāngshù dilation

分娩 fēnmǎn delivery

逆产 nìchǎn breech

怀孕 huáiyùn conception

胚胎 pēitāi embryo

破羊水 pòyángshuǐ break waters (v)

硬膜外麻醉 yìngmó wài mázui epidural

出生 chūshēng birth

早产的 zǎochǎnde premature

怀孕的 huáiyùnde pregnant

子宫 zǐgōng womb

羊水 yángshuǐ amniotic fluid

外阴切开术 wàiyīn qiēkāishù episiotomy

流产 liúchǎn miscarriage

妇科医生 fùkē yīshēng gynaecologist

待产的 dàichǎnde expectant

怀孕三个月 huáiyùnsāngèyuè trimester

羊水穿刺诊断 yángshuǐ chuāncǐ zhěnduàn amniocentesis

剖腹产 pōufùchǎn caesarean section

缝合 fénghé stitches

产科医生 chǎnkē yīshēng obstetrician

# 分娩 fēnmiǎn • childbirth

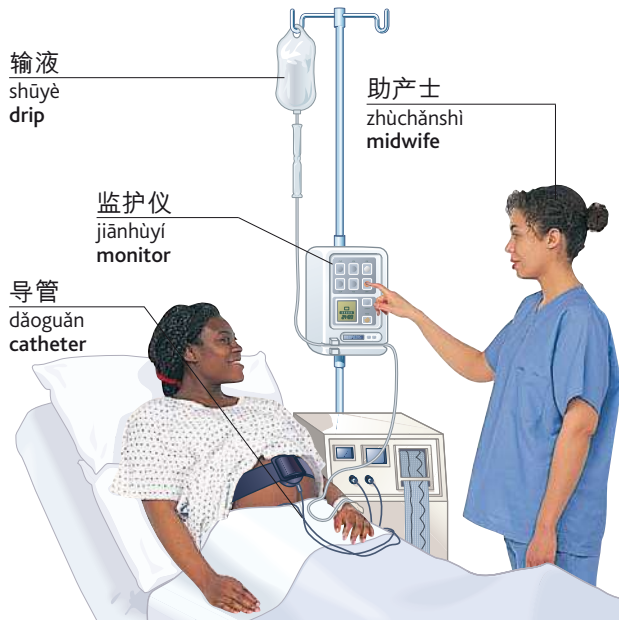

输液  
shūyè  
drip

助产士  
zhùchǎnshì  
midwife

监护仪  
jiānhùyí  
monitor

导管  
dǎoguǎn  
catheter

引产 yǐnchǎn | induce labour (v)



育婴箱 yùyīngxiāng | incubator



婴儿秤  
yīng'ěrchèng  
scales

出生时体重 chūshēngshí tǐzhòng | birth weight

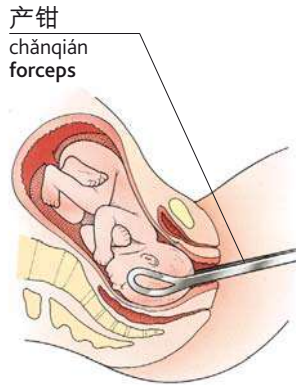

产钳  
chǎnqián  
forceps

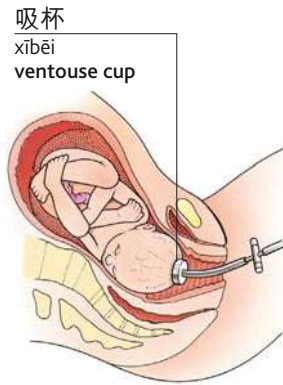

吸杯  
xībēi  
ventouse cup

助产  
zhùchǎn  
assisted delivery

身份标签  
shēnfēnbiāoqiān  
identity tag



新生儿 xīnshēng'ér | newborn baby

## 哺乳 bǔrǔ • nursing



吸乳器  
xīrǔqì  
breast pump



喂母乳  
bǔrǔ xiǒngzhào  
nursing bra



喂母乳  
wèi mǔrǔ  
breastfeed (v)



乳垫  
rǔdiàn  
pads

# 替代疗法 tìdài liáofǎ • alternative therapy

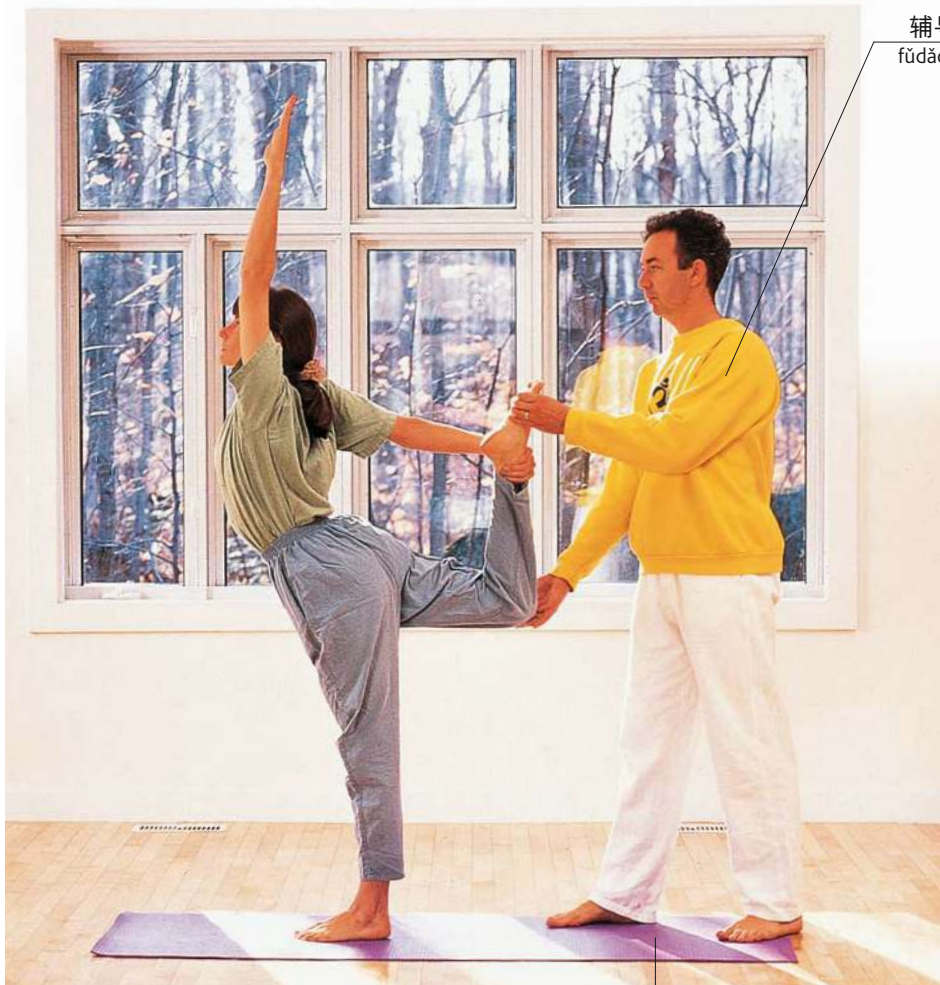

瑜伽 yújiā | yoga

辅导教师  
fúdǎo jiàoshī  
teacher



按摩  
ànmó  
massage



指压按摩  
zhǐyā ànmó  
shiatsu

垫子  
diànzi  
mat



脊柱按摩法  
jǐzhù ànmófǎ  
chiropractic



整骨疗法  
zhěnggǔ liáofǎ  
osteopathy



足底反射疗法  
zúdǐ fǎnshè liáofǎ  
reflexology



冥想  
míngxiǎng  
meditation



顾问  
gūwèn  
counsellor



集体治疗  
jítǐ zhìliáo  
group therapy



灵气疗法  
língqì liáofǎ  
reiki



针灸  
zhēnjiǔ  
acupuncture



印度草药疗法  
yīndù cǎoyào liáofǎ  
ayurveda



催眠疗法  
cuīmián liáofǎ  
hypnotherapy



本草疗法  
běncǎo liáofǎ  
herbalism

精油  
jīngyóu  
essential oils



芳香疗法  
fāngxiāng liáofǎ  
aromatherapy



顺势疗法  
shùnsì liáofǎ  
homeopathy



指压疗法  
zhǐyā liáofǎ  
acupressure

治疗师  
zhìliáoshī  
therapist



精神疗法  
jīngshén liáofǎ  
psychotherapy

词汇 cíhuì • vocabulary

营养品  
yíngyǎngpǐn  
supplement

自然疗法  
zìrán liáofǎ  
naturopathy

放松  
fàngsōng  
relaxation

药草  
yàocǎo  
herb

水疗  
shuǐliáo  
hydrotherapy

风水  
fēngshuǐ  
feng shui

压力  
yālì  
stress

水晶疗法  
shuǐjīng liáofǎ  
crystal healing









家居 jiājū  
home



# 房屋 fángwū • house

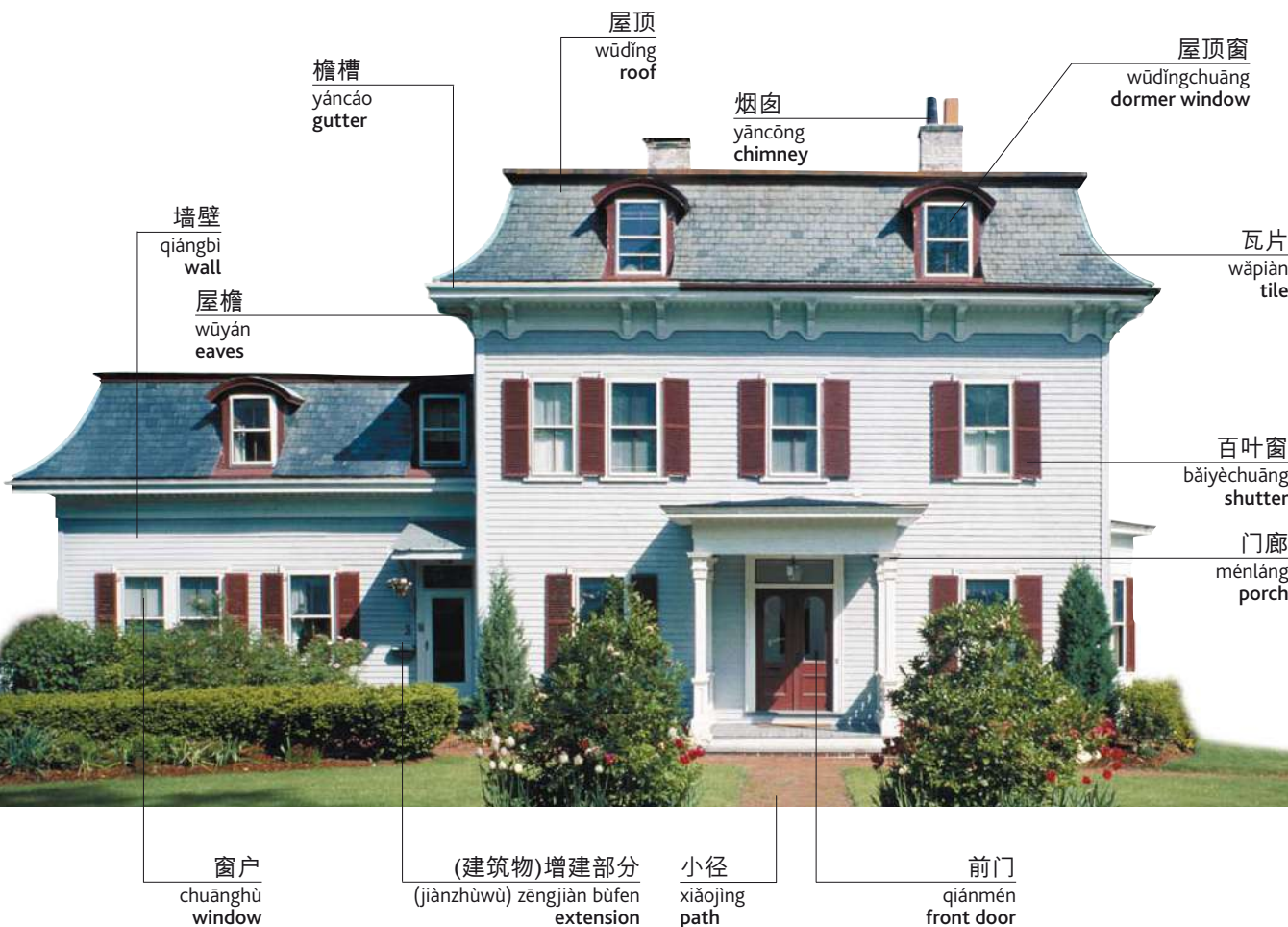

## 词汇 cíhuì • vocabulary

独立式  
dúlìshì  
detached

房客  
fángkè  
tenant

车库  
chēkù  
garage

信箱  
xìnxiāng  
letterbox

防盗警报  
fángdào jǐngbào  
burglar alarm

租用  
zūyòng  
rent (v)

半独立式  
bàndúlìshì  
semidetached

平房  
píngfáng  
bungalow

阁楼  
gélóu  
attic

门廊灯  
ménlángdēng  
porch light

庭院  
tíngyuàn  
courtyard

房租  
fángzū  
rent

独栋住宅  
dúdòngzhùzhái  
townhouse

地下室  
dìxiàshì  
basement

房间  
fángjiān  
room

房东  
fángdōng  
landlord

楼层  
lóucéng  
floor

连排式  
liánpáishì  
terraced

入口 rùkǒu • entrance

公寓 gōngyù • flat

扶手  
fúshǒu  
hand rail

楼梯  
lóutī  
staircase



楼梯平台  
lóutī píngtái  
landing

楼梯栏杆  
lóutī lángān  
banister

门厅  
méntīng  
hallway



门铃  
ménlíng  
doorbell



门垫  
méndiàn  
doormat



门环  
ménhuán  
door knocker



门链  
ménliàn  
door chain

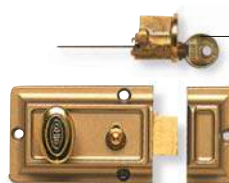

锁  
suǒ  
lock

钥匙  
yàoshi  
key



门闩  
ménshuān  
bolt



阳台  
yángtái  
balcony

公寓楼  
gōngyùlóu  
block of flats



对讲器  
duìjiǎngqì  
intercom



电梯  
diàntī  
lift

# 室内系统 shìnèi xìtǒng • internal systems



暖器片  
nuǎnqìpiàn  
radiator



电暖器  
diànnuǎnqì  
heater

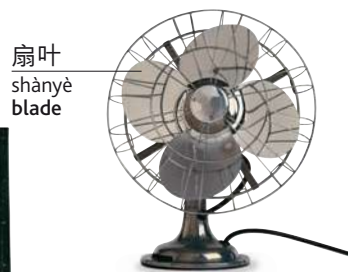

扇叶  
shànyè  
blade

风扇  
fēngshàn  
fan



对流式电暖器  
duìliúshì diànnuǎnqì  
convector heater

## 电 diàn • electricity



灯丝  
dēngsī  
filament

灯泡接口  
dēngpào jiēkǒu  
bayonet fitting

灯泡 dēngpào | light bulb

接地  
jiēdì  
earthing

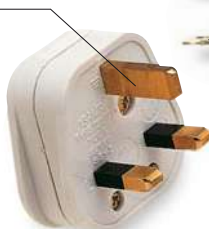

插头 chātóu | plug



插片  
chāpiàn  
pin

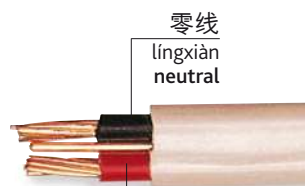

零线  
língxiàn  
neutral

火线  
huǒxiàn  
live

电线 diànxian | wires

## 词汇 cíhuì • vocabulary

电压  
diànyǎ  
voltage

保险丝  
bǎoxiǎnsī  
fuse

插座  
chāzuò  
socket

直流电  
zhíliúdiàn  
direct current

停电  
tíngdiàn  
power cut

安培  
ānpéi  
amp

保险盒  
bǎoxiǎnhé  
fuse box

开关  
kāiguān  
switch

变压器  
biànyǎqì  
transformer

供电系统  
gòngdiàn xìtǒng  
mains supply

电力  
diànlì  
power

发电机  
fādiànjī  
generator

交流电  
jiāoliúdiàn  
alternating current

电表  
diànbǎo  
electricity meter



# 管道装置 guǎndào zhuāngzhì • plumbing

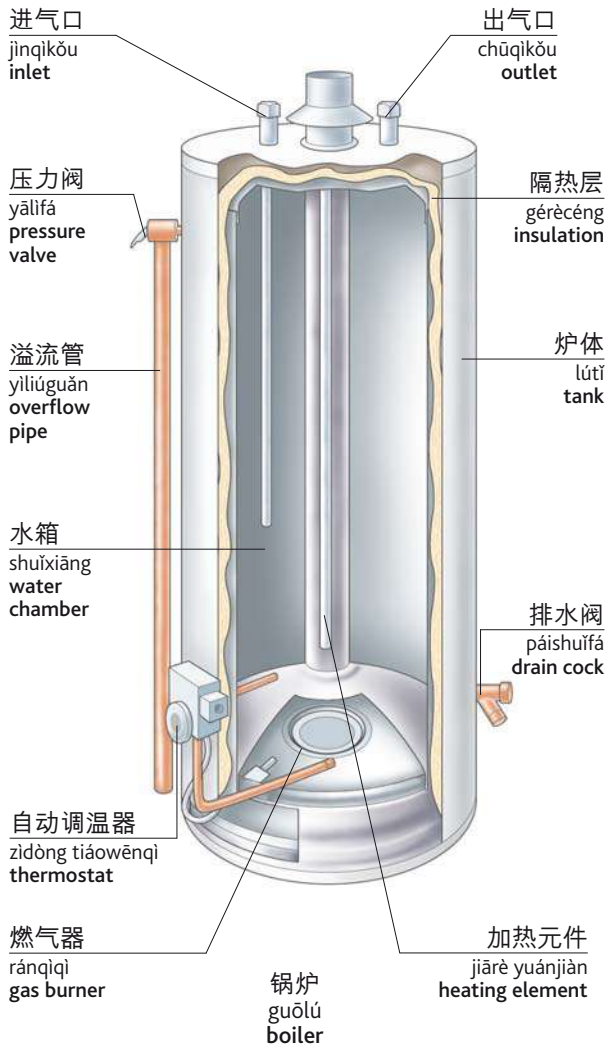

## 洗涤槽 xǐdí cáo • sink

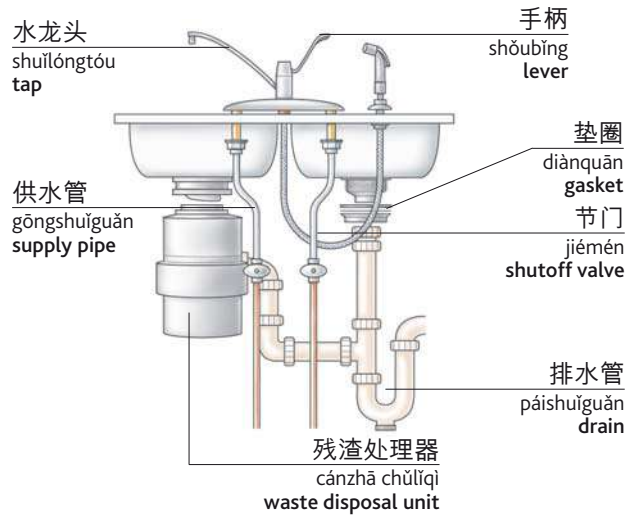

## 抽水马桶 chōushuǐ mǎtǒng • water closet

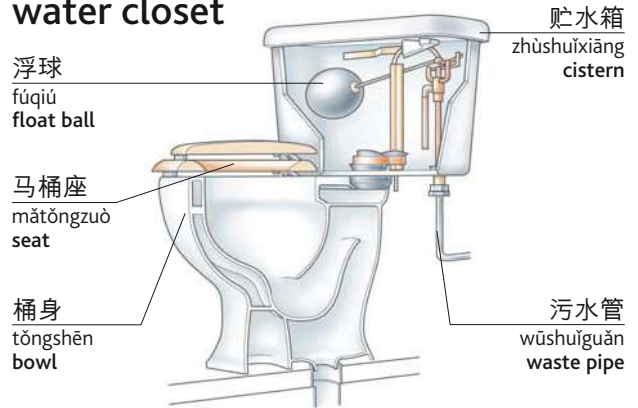

# 垃圾处理 lājǐchǔlǐ • waste disposal



# 起居室 qǐjūshì • living room

画  
huà  
painting

画框  
huàkuàng  
frame

灯  
dēng  
lamp

壁灯  
bìdēng  
wall light

钟表  
zhōngbiǎo  
clock

天花板  
tiānhuābǎn  
ceiling

储物柜  
chǔwùguì  
cabinet

沙发  
shāfā  
sofa

靠垫  
kàodiàn  
cushion

茶几  
chájī  
coffee table

地板  
dǐbǎn  
floor





镜子  
jìngzi  
mirror

花瓶  
huāpíng  
vase

壁炉台  
bìlútái  
mantelpiece

壁炉  
bìlú  
fireplace

挡火板  
dǎnghuǒbǎn  
screen

蜡烛  
làzhú  
candle

书架  
shūjià  
bookshelf

沙发床  
shāfāchuáng  
sofabed

地毯  
dìtǎn  
rug



窗帘  
chuānglián  
curtain



窗幔  
chuāngmàn  
net curtain



百叶窗  
bǎiyèchuāng  
venetian blind



卷帘  
juǎnlián  
roller blind

装饰脚线  
zhuāngshì jiǎoxiàn  
moulding

扶手椅  
fúshǒuyǐ  
armchair



书房 shūfáng | study



# 餐厅 cāntīng • dining room



## 词汇 cíhuì • vocabulary

摆桌子  
bǎizhuōzi  
lay the table (v)

饿  
è  
hungry

午餐  
wǔcān  
lunch

饱  
bǎo  
full

主人  
zhǔrén  
host

请再给我加一些，好吗？  
qǐng zài gěi wǒ jiā yīxiē, hǎoma?  
Can I have some more, please?

上菜  
shàngcài  
serve (v)

桌布  
zhuōbù  
tablecloth

晚餐  
wǎncān  
dinner

一份  
yīfèn  
portion

女主人  
nǚzhǔrén  
hostess

我吃饱了，谢谢。  
wǒ chībǎole, xièxiè.  
I've had enough, thank you.

吃  
chī  
eat (v)

早餐  
zǎocān  
breakfast

餐具垫  
cānjùdiàn  
place mat

饭菜  
fàncai  
meal

客人  
kèrén  
guest

很好吃。  
hěn hào chī.  
That was delicious.

餐具 cānjù • crockery and cutlery



马克杯  
mǎkèbēi  
mug



咖啡杯  
kāfēibēi  
coffee cup



茶杯  
chábēi  
teacup

茶匙  
cháchí  
teaspoon



盘子  
pánzi  
plate



碗  
wǎn  
bowl



咖啡壶  
kāfēihú  
cafetière



茶壶  
cháhú  
teapot



带柄水壶  
dàibǐngshuǐhú  
jug



蛋杯  
dànbei  
egg cup

酒杯  
jiǔbēi  
wine glass

平底玻璃杯  
píngdǐbōlibēi  
tumbler



玻璃器皿  
bōlibī qìpǐn  
glassware

餐巾套环  
cānjīn tàohuán  
napkin ring

甜点盘  
tiándiǎnpán  
side plate

正餐用盘  
zhèngcān  
yòngpán  
dinner plate

汤盆  
tāngpén  
soup bowl

汤匙  
tāngchí  
soup spoon



餐巾  
cānjīn  
napkin



餐叉  
cānchā  
fork



餐具摆放  
cānjù bǎifàng  
place setting



餐匙  
cānchí  
spoon

餐刀  
cāndāo  
knife

# 厨房 chúfáng • kitchen



# 厨房电器 chúfáng diànrì • appliances





制冰室  
zhìbīngshì  
ice maker

冷冻室  
lěngdòngshì  
freezer



冰箱  
bīngxiāng  
refrigerator

搁板  
gēbǎn  
shelf

蔬菜保鲜格  
shūcài bǎoxiāngé  
crisper

双门冰箱 shuāngmén bīngxiāng | fridge-freezer

词汇 cíhuì • vocabulary

餐具沥水架  
cānjù lishuǐjià  
draining board

火炉  
huǒlú  
burner

炉盘  
lúpán  
hob

垃圾桶  
lājītǒng  
rubbish bin

冷冻  
lěngdòng  
freeze (v)

解冻  
jiědòng  
defrost (v)

蒸  
zhēng  
steam (v)

炒  
chǎo  
sauté (v)

烹饪 pēngrèn • cooking



削皮  
xuēpí  
peel (v)



切片  
qiēpiàn  
slice (v)



擦碎  
cāsuì  
grate (v)



注水  
zhùshuǐ  
pour (v)



搅拌  
jiǎobàn  
mix (v)



搅打  
jiǎodǎ  
whisk (v)



煮沸  
zhǔfèi  
boil (v)



煎  
jiān  
fry (v)



擀  
gǎn  
roll (v)



搅动  
jiǎodòng  
stir (v)



文火烧，煨，炖  
wénhuǒ shāo, wēi, dùn  
simmer (v)



沸水煮  
fèishuǐzhǔ  
poach (v)



烘制  
hōngzhì  
bake (v)



烤制  
kǎozhì  
roast (v)



烧烤  
shāokǎo  
grill (v)

# 厨具 chújù • kitchenware



案板  
ànbǎn  
chopping board

面包刀

miànbāodāo  
bread knife



厨刀  
chúdāo  
kitchen knife



切肉刀  
qièròudāo  
cleaver



磨刀器  
módaoqì  
knife sharpener



松肉槌  
sōngròuchuí  
meat tenderizer



串肉扦  
chuànròuqiān  
skewer



礞床  
cǎchuáng  
grater



研钵  
yánbō  
mortar

研杵  
yánchǔ  
pestle



捣泥器  
dǎoníqì  
masher



削皮刀  
xuēpídao  
peeler



苹果去核器  
píngguǒ qùhéqì  
apple corer



开罐器  
kāiguǎnqì  
can opener



开瓶器  
kāipíngqì  
bottle opener



压蒜器  
yāsuǎnqì  
garlic press



分餐匙  
fēncānchí  
serving spoon



煎鱼铲  
jiānyúchǎn  
fish slice



滤锅  
lǜguō  
colander



刮铲  
guāchǎn  
spatula



木勺  
mùsháo  
wooden spoon



漏勺  
lòusháo  
slotted spoon



长柄勺  
chángbǐngsháo  
ladle



切肉叉  
qièròuchā  
carving fork



深口圆匙  
shēnkǒu yuánchí  
scoop



打蛋器  
dǎdànqì  
whisk



滤网  
lǜwǎng  
sieve



## 蛋糕制作 dàngāo zhìzuò • baking cakes





# 卧室 wòshì • bedroom

衣橱  
yīchú  
wardrobe

床头灯  
chuángtóudēng  
bedside lamp

床头板  
chuángtóubǎn  
headboard

床头柜  
chuángtóugui  
bedside table

五斗橱  
wūdǒuchú  
chest of drawers



抽屉  
chōuti  
drawer

床  
chuáng  
bed

床垫  
chuángdiàn  
mattress

床罩  
chuángzhào  
bedspread

枕头  
zhěntóu  
pillow



暖水袋  
nuǎnshuǐdài  
hot-water bottle



时钟收音机  
shízhōng shōuyīnjī  
clock radio



闹钟  
nàozhōng  
alarm clock



纸巾盒  
zhījīnhé  
box of tissues



衣架  
yǐjià  
coat hanger

床上用品 chuángshàng yòngpǐn • bed linen



镜子  
jìngzi  
mirror

梳妆台  
shūzhuāngtái  
dressing table

地板  
dìbǎn  
floor



枕套  
zhěntào  
pillowcase

床单  
chuángdān  
sheet

床帷  
chuángwéi  
valance

羽绒被  
yǔróngbèi  
duvet

棉被  
miánbèi  
quilt

毯子  
tǎnzi  
blanket



词汇 cíhuì • vocabulary

单人床  
dānrénchuáng  
single bed

床脚板  
chuángjiǎobǎn  
footboard

失眠  
shīmián  
insomnia

醒来  
xǐnglái  
wake up (v)

设定闹钟  
shèdìng nàozhōng  
set the alarm (v)

双人床  
shuāngrénchuáng  
double bed

弹簧  
tánhuáng  
spring

上床睡觉  
shàngchuáng shuìjiào  
go to bed (v)

起床  
qǐchuáng  
get up (v)

打鼾  
dǎhān  
snore (v)

电热毯  
diànrètǎn  
electric blanket

地毯  
dìtǎn  
carpet

入睡  
rùshuì  
go to sleep (v)

整理床铺  
zhěnglǐ chuángpù  
make the bed (v)

内嵌式衣橱  
nèiqiànshì yīchú  
built-in wardrobe

# 浴室 yùshì • bathroom

毛巾架  
máo jīn jià  
towel rail

淋浴隔门  
lín yù gé mén  
shower door

冷水龙头  
lěng shuǐ lóng tóu  
cold tap

热水龙头  
rè shuǐ lóng tóu  
hot tap

淋浴喷头  
lín yù pēn tóu  
shower head

洗手池  
xǐ shǒu chí  
washbasin

塞子  
sāi zi  
plug



浴缸  
yù gāng  
bathtub



净身盆 jìng shēn pén | bidet



淋浴  
lín yù  
shower

地漏  
dì lòu  
drain

马桶座  
mǎ tǒng zuò  
toilet seat

抽水马桶  
chōu shuǐ mǎ tǒng  
toilet

马桶刷  
mǎ tǒng shuā  
toilet brush

## 词汇 cíhuì • vocabulary

家用药箱  
jiā yòng yào xiāng  
medicine cabinet

浴室防滑垫  
yù shì fǎng huá diàn  
bath mat

卫生纸  
wèi shēng zhǐ  
toilet roll

淋浴隔帘  
lín yù gé lián  
shower curtain

洗淋浴  
xǐ lín yù  
take a shower (v)

洗澡  
xǐ zǎo  
take a bath (v)

## 口腔卫生 kǒu qiāng wèi shēng • dental hygiene



牙刷  
yá shuā  
toothbrush



牙线  
yá xiàn  
dental floss



牙膏  
yá gāo  
toothpaste



漱口水  
shù kǒu yè  
mouthwash





丝瓜络  
sīguāluò  
loofah

海绵  
hǎimián  
sponge



浮石  
fúshí  
pumice stone



背刷  
bèishuā  
back brush



除臭剂  
chúchòuji  
deodorant

肥皂盒  
féizǎohé  
soap dish



肥皂  
féizào  
soap

沐浴乳  
mùyǔrǔ  
shower gel



面霜  
miànshuāng  
face cream



泡泡浴液  
pàopào yùyè  
bubble bath



浴袍  
yùpáo  
bathrobe

擦手巾  
cāshǒujīn  
hand towel



毛巾  
máojīn  
towels

浴巾  
yùjīn  
bath towel



润肤露  
rùnfúlù  
body lotion



爽身粉  
shuǎngshēnfěn  
talcum powder

## 剃须 tìxū • shaving



电动剃须刀  
diàndòng tìxūdāo  
electric razor



剃须泡沫  
tìxūpàomò  
shaving foam



一次性剃须刀  
yícìxìng tìxūdāo  
disposable razor



剃刀刀片  
tīdāo dāopiàn  
razor blade



须后水  
xūhòushuǐ  
aftershave

# 育婴室 yùyīngshì • nursery

## 婴儿护理 yīng'ér hùlǐ • baby care



海绵  
hǎimián  
sponge

尿疹膏  
niàozhēngāo  
nappy rash cream

婴儿浴盆  
yīng'ér yùpén  
baby bath



湿纸巾  
shīzhǐjīn  
wet wipe



婴儿便盆  
yīng'ér biànpén  
potty



换衣垫  
huànyīdiàn  
changing mat

## 睡眠 shuìmián • sleeping

活动玩具  
huódòng wánjù  
mobile



床垫  
chuángdiàn  
mattress  
婴儿床 yīng'érchuáng | cot

床单  
chuángdān  
sheet

毯子  
tǎnzi  
blanket

栏杆  
lángān  
bars

羊毛毯  
yángmáotǎn  
fleece

护围  
hùwéi  
bumper



拨浪鼓  
bōlàngǔ  
rattle



被褥  
bèirù  
bedding



婴儿睡篮  
yīng'ér shuìlán  
moses basket

游戏 yóuxì • playing



安全 ānquán  
• safety



饮食 yǐnshí  
• eating



外出 wàichū • going out





# 洗衣间 xǐyījiān • utility room

## 洗涤 xǐdí • laundry

脏衣物  
zāngyīwù  
dirty washing



洗衣篮  
xǐyīlán  
laundry basket



洗衣机  
xǐyījī  
washing machine



洗衣干衣机  
xǐyī gānyījī  
washer-dryer



滚筒式烘干机  
gǔntǒngshì hōnggānjī  
tumble dryer

干净衣物  
gānjìng yīwù  
clean clothes



衣物篮  
yīwùlán  
linen basket

衣服夹  
yīfújiá  
clothes peg



晾干  
liàngān  
dry (v)

晾衣绳  
liàngyīshéng  
clothes line



熨衣板 yùnyībǎn | ironing board



熨斗  
yùndǒu  
iron

### 词汇 cíhuì • vocabulary

装入  
zhuāngrù  
load (v)

甩干  
shuǎigàn  
spin (v)

熨烫  
yùntàng  
iron (v)

洗衣机怎么用?  
xǐyījī zěnmeyòng?  
How do I operate the washing machine?

漂洗  
piǎoxǐ  
rinse (v)

甩干机  
shuǎigànjī  
spin dryer

织物柔顺剂  
zhīwù róushùnjì  
fabric conditioner

如何设定洗染色/白色衣物?  
rúhé shèdìng xǐ rǎnsè/báisè yīwù?  
What is the setting for coloureds/whites?

清洁用具 qīngjiéyòngjù • cleaning equipment



扫除 sāochú • activities



擦  
cā  
clean (v)



洗  
xǐ  
wash (v)



擦拭  
cāshì  
wipe (v)



刷洗  
shuāxǐ  
scrub (v)



刮除  
guāchú  
scrape (v)



清扫  
qīngsǎo  
sweep (v)



除尘  
chúchén  
dust (v)



上光  
shàngguāng  
polish (v)

# 工作间 gōngzuòjiān • workshop

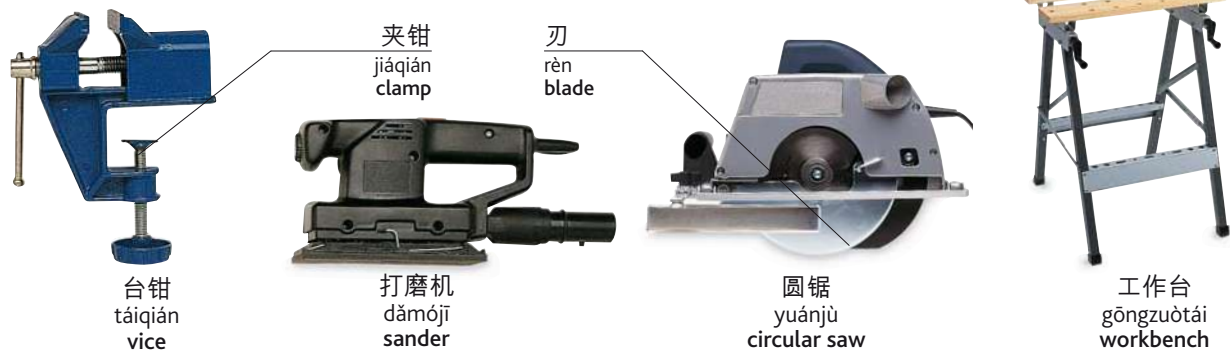

木材胶  
mùcáijiāo  
wood glue

槽刨  
cáopáo  
router

刨花  
bào huā  
wood shavings



工具架  
gōngjùjià  
tool rack

手摇曲柄钻  
shǒuyáo  
qūbǐngzuàn  
bit brace

电源箱延长线  
diànyuánxiāng  
yǎnchángxiàn  
extension lead



## 技艺 jìyì • techniques



切割  
qiēgē  
cut (v)



锯  
jù  
saw (v)



钻孔  
zuànkǒng  
drill (v)



钉  
dīng  
hammer (v)



刨 páo | plane (v)

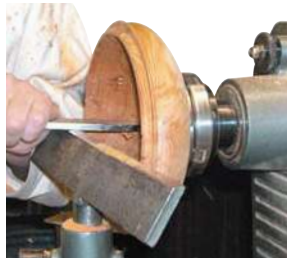

车削 chēxiāo | turn (v)

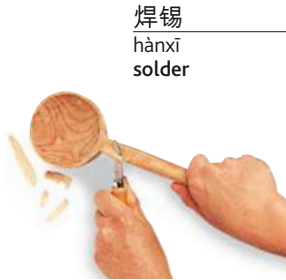

焊锡  
hànxi  
solder  
雕刻 diāokè | carve (v)

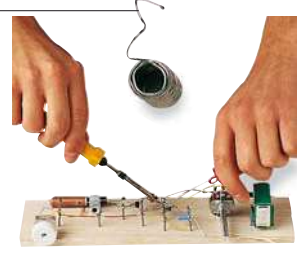

焊接 hànjiē | solder (v)

## 材料 cáiliào • materials

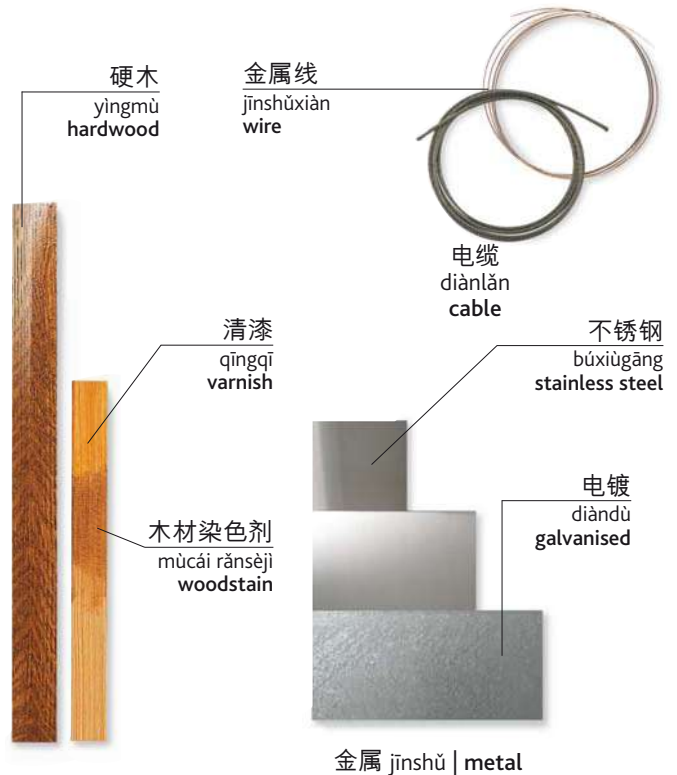
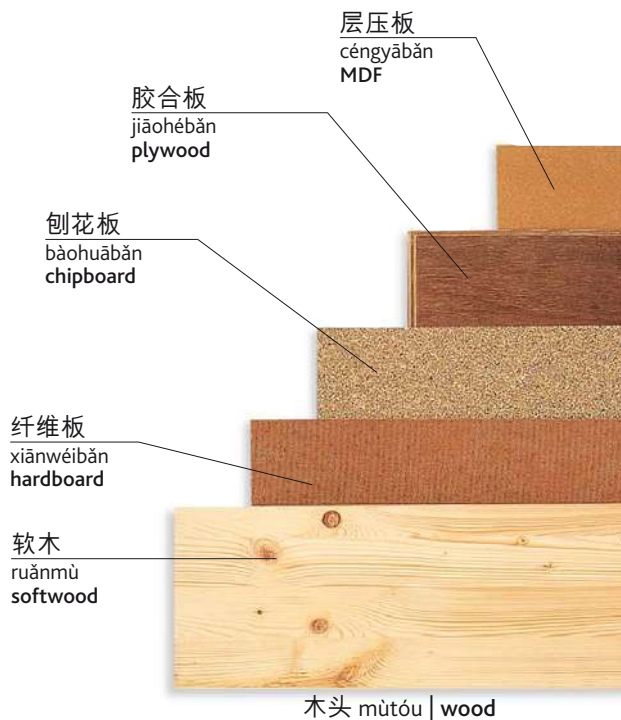

# 工具箱 gōngjùxiāng • toolbox

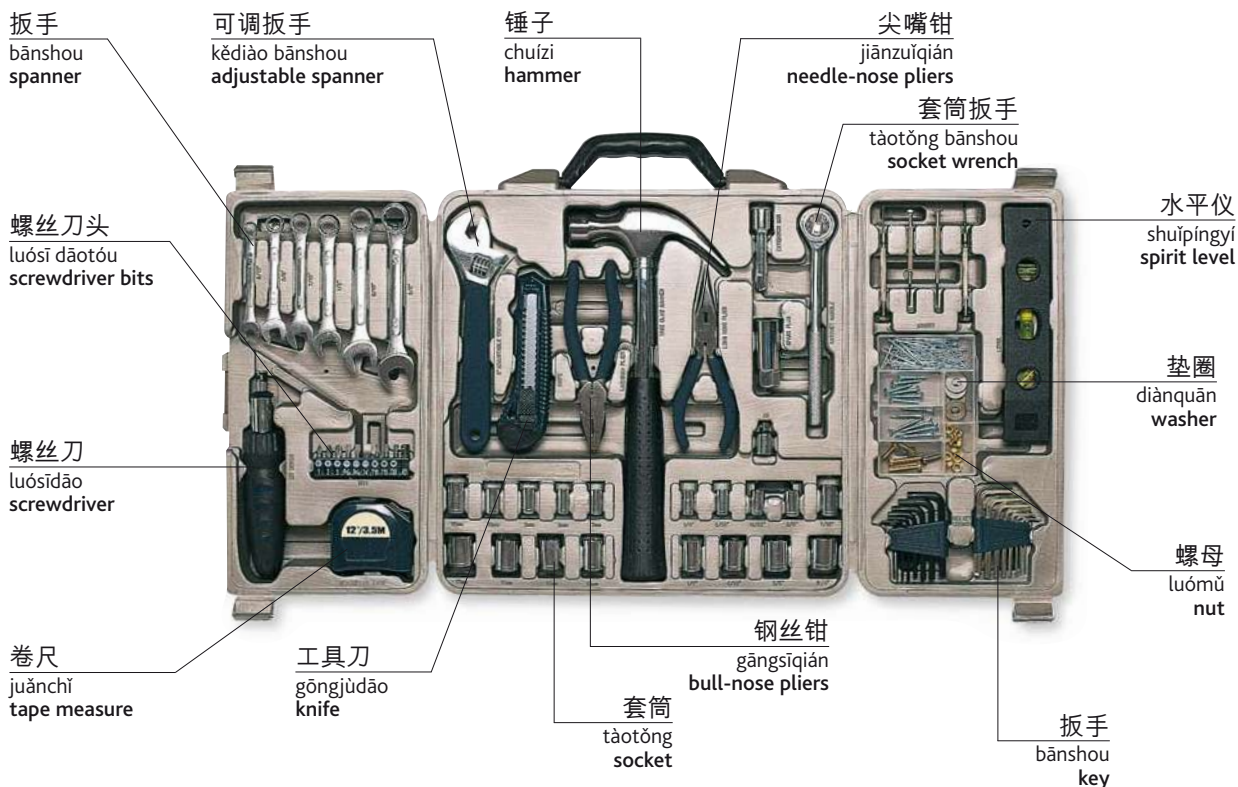

## 钻头 zuàntóu • drill bits

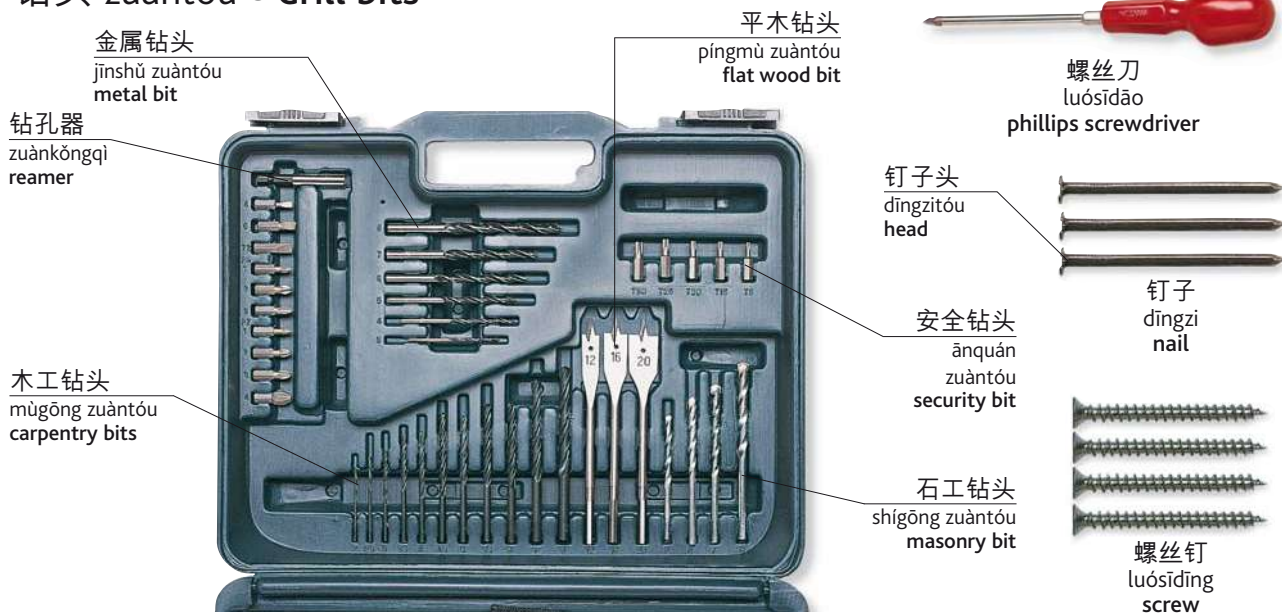

剥皮钳  
bāopíqiān  
wire strippers

铁丝剪  
tiěsījiǎn  
wire cutters

烙铁  
làotie  
soldering iron

绝缘胶带  
juéyuán  
jiāodài  
insulating  
tape



线锯  
xiànjù  
fretsaw

切割刀  
qiēgēdāo  
scalpel



开榫锯 kāisǔnjù | tenon saw

焊锡  
hànxi  
solder



护目镜  
hùmùjǐng  
safety goggles



刨子  
bàozi  
plane



斜锯架  
xiéjùjià  
mitre block



手锯  
shǒujù  
handsaw



手摇钻  
shǒuyáozuàn  
hand drill



钢丝绒  
gāngsīróng  
wire wool



钢锯  
gāngjù  
hacksaw



砂纸  
shāzhǐ  
sandpaper

扳钳  
bānqiān  
wrench



凿子  
záozi  
chisel



磨刀石  
módao shí  
sharpening stone



锉刀  
cuòdāo  
file



切管机 qiēguǎnjī | pipe cutter

搯子  
chuāizi  
plunger





# 装修 zhuāngxiū • decorating



剪刀  
jiǎndāo  
scissors



工艺刀  
gōngyidāo  
craft knife



铅锤线  
qiānchuíxiàn  
plumb line



刮刀  
guādāo  
scraper

裱糊匠  
biǎohújiàng  
decorator

壁纸  
bìzhǐ  
wallpaper

折梯  
zhétī  
stepladder



裱糊刷  
biǎohúshuā  
wallpaper brush

裱糊台  
biǎohútái  
pasting table

上浆刷  
shàngjiāngshuā  
pasting brush

壁纸黏合剂  
bìzhǐ niánhéjī  
wallpaper paste

桶  
tǒng  
bucket

贴壁纸 tiēbìzhǐ | wallpaper (v)



铲掉 chǎndiào | strip (v)



抹 mǒ | fill (v)



用砂纸打磨 yòng shāzhǐ dǎmó  
sand (v)



粉刷 fēnshuā | plaster (v)



贴(墙纸) tiē(qiángzhǐ) | hang (v)



铺砖 pūzhuān | tile (v)



刷漆 shuāqī | paint (v)

油漆滚筒  
yóuqī gǔntǒng  
roller



油漆盘  
yóuqīpán  
paint tray



油漆  
yóuqī  
paint

刷子  
shuāzi  
brush



海绵  
hǎimián  
sponge



遮蔽胶带  
zhēbì jiāodài  
masking tape



砂纸  
shāzhǐ  
sandpaper

油漆桶  
yóuqītǒng  
paint tin

工装裤  
gōngzhuāngkù  
overalls

防尘布  
fángchénbù  
dustsheet



松节油  
sōngjiéyóu  
turpentine

填料  
tiánliào  
filler



稀释剂  
xīshìjì  
white spirit

词汇 cíhuì • vocabulary

石膏  
shígāo  
plaster

有光泽  
yǒuguāngzé  
gloss

压花纸  
yāhuāzhǐ  
embossed paper

内涂层  
nèitúcéng  
undercoat

密封胶  
mìfēngjì  
sealant

清漆  
qīngqī  
varnish

无光泽  
wúguāngzé  
mat

衬纸  
chènzhǐ  
lining paper

外涂层  
wàitúcéng  
top coat

溶剂  
róngjì  
solvent

无光漆  
wúguāngqī  
emulsion

花样模板  
huāyàng múbǎn  
stencil

底漆  
dǐqī  
primer

防腐剂  
fángfǔjì  
preservative

薄胶浆  
báojiāojiāng  
grout



# 花园 huāyuán • garden

## 花园风格 huāyuánfēnggé • garden styles



内院 nèiyuàn | patio garden



屋顶花园  
wūdǐng huāyuán  
roof garden



岩石园  
yánshíyuán  
rock garden



庭院 tíngyuàn | courtyard



法式花园 fàshì huāyuán | formal garden



乡间花园  
xiāngjiān huāyuán  
cottage garden



香草花园  
xiāngcǎo huāyuán  
herb garden



水景花园  
shuǐjǐng huāyuán  
water garden

## 花园装饰 huāyuán zhuāngshì • garden features



吊篮  
diàolán  
hanging basket



花格屏 huāgéping | trellis



藤架  
téngjià  
pergola



# 土壤 tǔrǎng ● soil

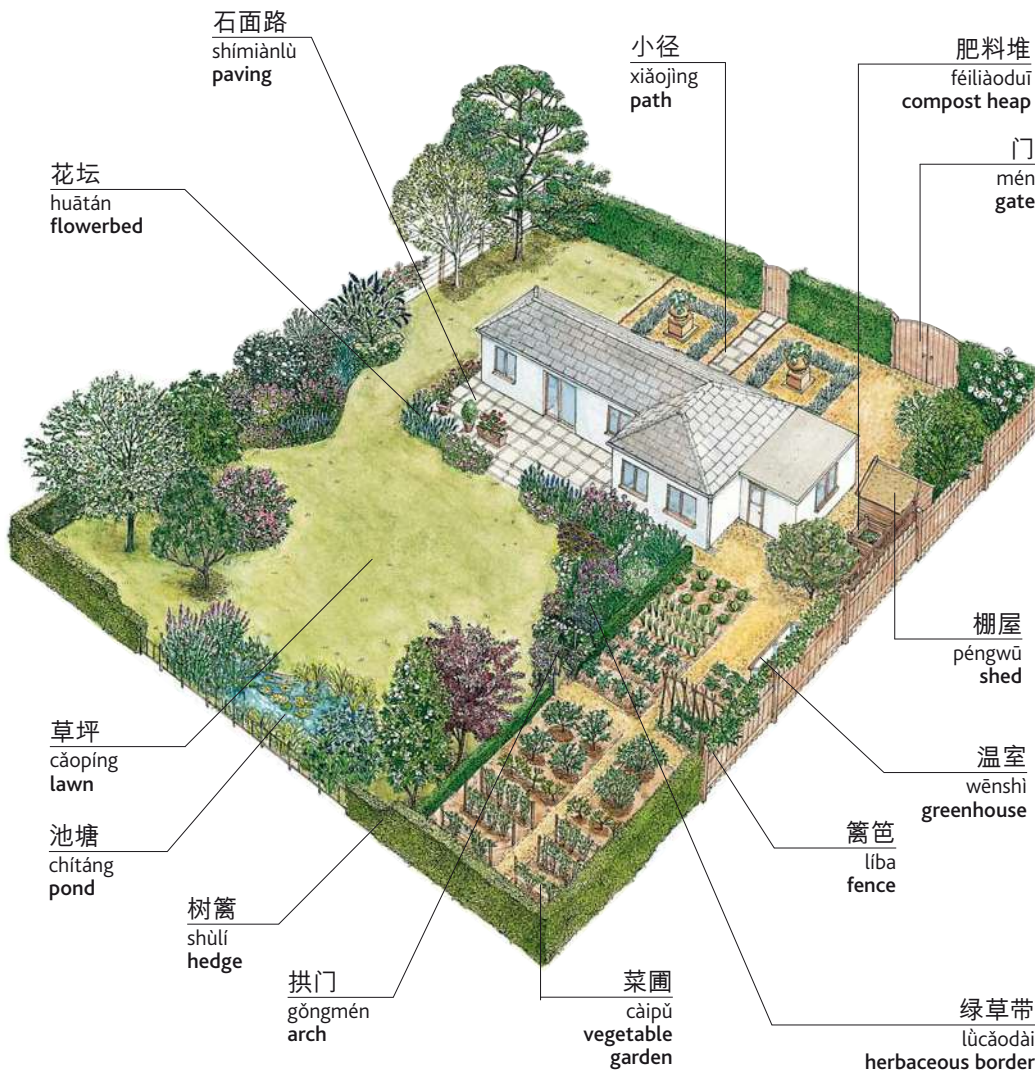

表层土  
biǎocéngtǔ  
topsoil



沙土  
shātǔ  
sand



石灰石  
shíhuīshí  
chalk



淤泥  
yūní  
silt



黏土  
niántǔ  
clay



铺面  
pùmiàn  
decking



喷泉 pēnquán | fountain



# 花园植物 huāyuánzhíwù • garden plants

## 植物种类 zhíwùzhǒnglèi • types of plants



一年生(植物)  
yīniánshēng (zhíwù)  
annual



二年生(植物)  
èrniánshēng (zhíwù)  
biennial



多年生(植物)  
duōniánshēng (zhíwù)  
perennial



球茎植物  
qiújīng zhíwù  
bulb



蕨类植物  
juélèi zhíwù  
fern



灯心草  
dēngxīncǎo  
rush



竹子  
zhúzi  
bamboo



杂草  
zácǎo  
weeds



药草  
yàocǎo  
herb



水生植物  
shuǐshēng zhíwù  
water plant



树  
shù  
tree



落叶(植物)  
luòyè (zhíwù)  
deciduous



棕榈  
zōnglǚ  
palm



针叶树  
zhēnyèshù  
conifer



常绿(植物)  
chánglǜ (zhíwù)  
evergreen





灌木修剪  
guànmù xiūjiǎn  
topiary



高山植物  
gāoshān zhíwù  
alpine



肉质植物  
ròuzhì zhíwù  
succulent



仙人掌  
xiānrénzhǎng  
cactus

盆栽植物  
pénzāi zhíwù  
potted plant

阴地植物  
yīndì zhíwù  
shade plant

攀缘植物  
pānyuán zhíwù  
climber

开花灌木  
kāihuā guànmù  
flowering shrub

地被植物  
dìbèi zhíwù  
ground cover



匍匐植物  
púfú zhíwù  
creeper

观赏(植物)  
guānshǎng  
(zhíwù)  
ornamental

草  
cǎo  
grass



# 园艺工具 yuányì gōngjù • garden tools



铲 chǎn  
spade



叉 chā  
fork



长柄修篱剪 chángbǐng xiūlíjiǎn  
long-handled shears



搂草耙 lǒucǎopá  
lawn rake



耙子 pázi  
rake



锄头 chútóu  
hoe



堆肥 duīfēi  
compost



种子 zhǒngzi  
seeds



骨粉 gǔfěn  
bone meal



碎石 suìshí  
gravel



草袋 cǎodài  
grass bag

马达 mǎdá  
motor

把手 bǎshǒu  
handle

防护盘 fānghùpán  
shield

修剪器 jiǎncǎoqì  
trimmer

除草机 jiǎncǎojī  
lawnmower



浅底篮 qiǎndǐlán  
trug



支架 zhījià  
stand

独轮手推车 dúlún shǒutuìchē  
wheelbarrow



浇灌 jiāoguàn • watering





# 园艺 yuányì • gardening

草地  
cǎodì  
lawn

花坛  
huātán  
flowerbed

割草机  
gēcǎojī  
lawnmower



树篱  
shùlǐ  
hedge

树木支柱  
shùmù zhīzhūāng  
stake

割草 gēcǎo | mow (v)



铺草皮  
pūcǎopí  
turf (v)



钉  
dīng  
spike (v)



耙  
pá  
rake (v)



修枝  
xiūzhī  
trim (v)



挖  
wā  
dig (v)



播种  
bōzhǒng  
sow (v)



土表施肥  
tǔbiǎo shīféi  
top dress (v)



浇水  
jiāoshuǐ  
water (v)





整枝  
zhěngzhī  
train (v)



摘除枯花  
zhāichú kūhuā  
deadhead (v)

喷水  
pēnshuǐ  
spray (v)



支撑杆  
zhīchēnggān  
cane



嫁接  
jiàjiē  
graft (v)



插条  
chātiao  
cutting

插枝  
chāzhī  
propagate (v)

修剪  
xiūjiǎn  
prune (v)

用杆支撑  
yònggān zhīchēng  
stake (v)



移植  
yízhí  
transplant (v)



清除杂草  
qīngchú zácao  
weed (v)



加护盖物  
jiā hùgàiwù  
mulch (v)

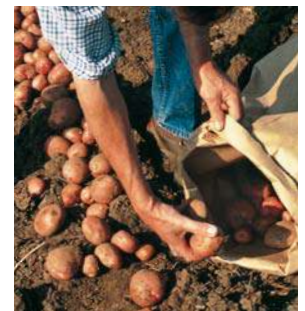

收获  
shōuhuò  
harvest (v)

词汇 cíhuì • vocabulary

栽培  
zāipéi  
cultivate (v)

园艺设计  
yuányì shèjì  
landscape (v)

施肥  
shīféi  
fertilize (v)

筛  
shāi  
sieve (v)

有机(栽培)的  
yǒuji(zāipéi)de  
organic

秧苗  
yāngmiáo  
seedling

底土  
dītǔ  
subsoil

护理  
hùlǐ  
tend (v)

把...种于盆内  
bǎ...zhòng yú  
pénnei  
pot up (v)

采摘  
cǎizhāi  
pick (v)

松土  
sōngtǔ  
aerate (v)

排水  
páishuǐ  
drainage

肥料  
féiliào  
fertilizer

除草剂  
chúcǎoji  
weedkiller





2

JKL

5

TUV

7

8

SYMBOL

0



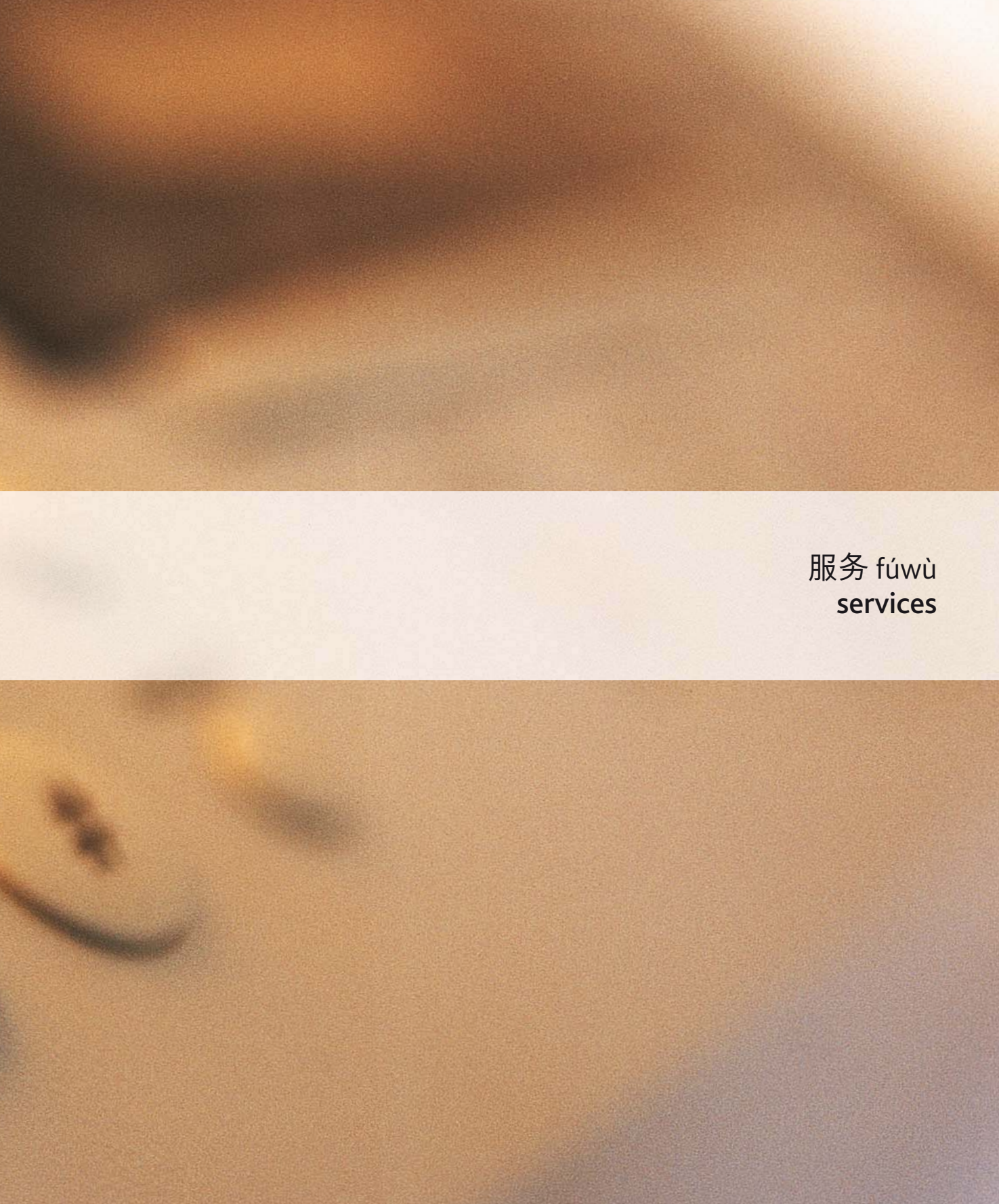

服务 fúwù  
services



# 急救 jǐjiù • emergency services

## 救护车 jiùhùchē • ambulance



救护车 jiùhùchē | ambulance



担架  
dānjià  
stretcher

急救人员 jǐjiù rényuán | paramedic

## 警察 jǐngchá • police

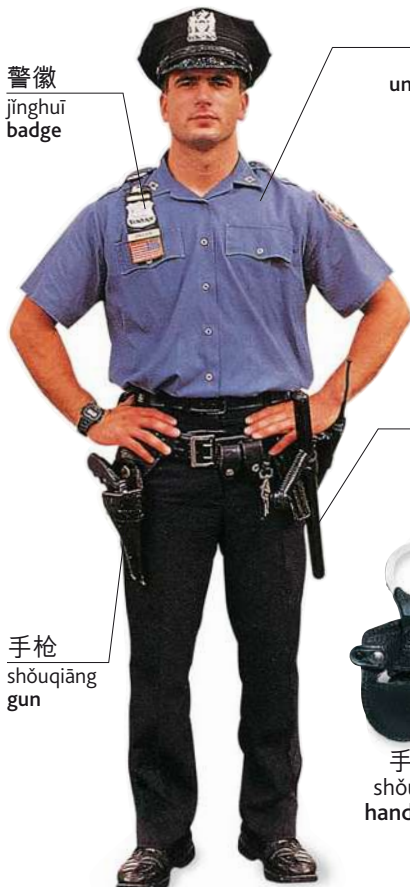

警徽  
jǐnghuī  
badge

制服  
zhìfú  
uniform

警笛  
jǐngdí  
siren

警灯  
jǐngdēng  
lights



警车  
jǐngchē  
police car



警察局  
jǐngchájú  
police station

警棍  
jǐnggùn  
truncheon



手铐  
shǒukào  
handcuffs

手枪  
shǒuqiāng  
gun

警官 jǐngguān | police officer

### 词汇 cíhuì • vocabulary

探员  
tànyuán  
inspector

嫌疑犯  
xiányifàn  
suspect

起诉  
qǐsù  
complaint

逮捕  
dàibǔ  
arrest

罪行  
zuìxíng  
crime

攻击  
gōngjī  
assault

调查  
diàochá  
investigation

单人牢房  
dānrén láofáng  
police cell

侦探  
zhēntàn  
detective

指纹  
zhǐwén  
fingerprint

入室盗窃  
rùshì dàoqiè  
burglary

控告  
kònggào  
charge

# 消防队 xiāofángduì • fire brigade



火情 huǒqíng | fire



消防站  
xiāofángzhàn  
fire station



消防通道  
xiāofángtōngdào  
fire escape



消防车  
xiāofángchē  
fire engine



烟雾报警器  
yānwù bàojǐngqì  
smoke alarm



火灾报警器  
huǒzāi jǐngbàoqì  
fire alarm



消防斧  
xiāofángfǔ  
axe



灭火器  
mièhuǒqì  
fire extinguisher



消防栓  
xiāofángshuān  
hydrant

我需要警察/消防队/救护车。  
wǒ xūyào jǐngchá/xiāofángduì/jiùhùchē.  
I need the police/fire brigade/  
ambulance.

在...有火情。  
zài...yǒu huǒqíng.  
There's a fire at...

发生了事故。  
fāshēngle shìgù.  
There's been an accident.

报警!  
bàojǐng!  
Call the police!



# 银行 yínháng • bank

客户  
kèhù  
customer

窗口  
chuāngkǒu  
window

出纳员  
chūnàyuán  
cashier



宣传页  
xuānchuányè  
leaflets

柜台  
guìtái  
counter

存款单  
cúnguǎndān  
paying-in slips



银行经理  
yínháng jīnglǐ  
bank manager

银行卡  
yínhángkǎ  
debit card



信用卡  
xìnyòngkǎ  
credit card

支票存根  
zhīpiào  
cúngēn

账号  
zhàngào  
account number

签名  
qiānmíng  
signature

金额  
jīn'é  
amount



支票簿  
zhīpiàobù  
chequebook

支票  
zhīpiào  
cheque

## 词汇 cíhuì • vocabulary

储蓄  
chǔxù  
savings

抵押贷款  
dīyā dàikuǎn  
mortgage

付款  
fùkuǎn  
payment

存入  
cúnrù  
pay in (v)

活期存款账户  
huóqīcúnguǎn zhàngù  
current account

税  
shuì  
tax

透支  
tòuzhī  
overdraft

直接借记  
zhíjiē jièjì  
direct debit

银行手续费  
yínháng shǒuxùfèi  
bank charge

储蓄账户  
chǔxù zhàngù  
savings account

贷款  
dàikuǎn  
loan

利率  
lǐlǜ  
interest rate

取款单  
qǔkuǎndān  
withdrawal slip

银行转账  
yínháng zhuǎnzhang  
bank transfer

密码  
mimǎ  
pin number

硬币  
yingbi  
coin



货币 huòbì | money

纸币  
zhǐbì  
note

屏幕  
píngmù  
screen

按键区  
ànjiànqū  
key pad



提款机 tíkuǎnjī | cash machine

插卡口  
chākǎkǒu  
card slot

## 外币 wàibì • foreign currency

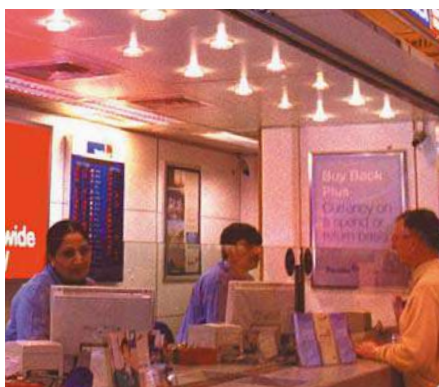

外币兑换处  
wàibì duìhuànchù  
bureau de change



旅行支票  
lǚxíng zhīpiào  
traveller's cheque



汇率  
huìlǜ  
exchange rate

## 词汇 cíhuì • vocabulary

兑现  
duìxiàn  
cash (v)

货币面额  
huòbì miàné  
denomination

佣金  
yòngjīn  
commission

投资  
tóuzī  
investment

证券  
zhèngquàn  
stocks

股份  
gǔfèn  
shares

股息  
gǔxī  
dividends

会计师  
kuàijìshī  
accountant

有价证券组合  
yǒujià zhèngquàn zǔhé  
portfolio

股权  
gǔquán  
equity

我能兑换吗？  
wó néng duìhuàn ma?  
Can I change this please?

今天的汇率是多少？  
jīntiān de huìlǜ shì duōshǎo?  
What's today's exchange rate?

## 金融 jīnróng • finance

股票价格  
gǔpiào jiàgé  
share price

股票经纪人  
gǔpiào jīngjìrén  
stockbroker



投资顾问  
tóuzī gǔwèn  
financial advisor



证券交易所 zhèngquàn jiāoyìsuǒ  
stock exchange



# 通讯 tōngxùn • communications

邮局职员  
yóujú zhíyuán  
postal worker

窗口  
chuāngkǒu  
window

秤  
chèng  
scales

柜台  
guìtái  
counter



邮局 yóujú | post office



邮递员  
yóudìyuán  
postman

邮戳  
yóuchuō  
postmark

邮票  
yóupiào  
stamp

地址  
dìzhǐ  
address

邮政编码  
yóuzhèngbiānmǎ  
postal code



信封 xìnfēng | envelope

## 词汇 cíhuì • vocabulary

信  
xìn  
letter

寄信人地址  
jìxìnrén dìzhǐ  
return address

递送  
dìsòng  
delivery

易损坏  
yìsǔnhuài  
fragile

勿折  
wùzhé  
do not bend (v)

航空邮件  
hángkōng yóujiàn  
by airmail

签名  
qiānmíng  
signature

汇票  
huìpiào  
postal order

邮袋  
yóudài  
mailbag

此面向上  
cǐmiàn xiàngshàng  
this way up

挂号邮件  
guàhào yóujiàn  
registered post

(从邮筒中)取信  
(cóng yóutǒng zhōng) qǔxìn  
collection

邮资  
yóuzī  
postage

电报  
diànbào  
telegram

传真  
chuánzhēn  
fax



邮筒  
yóutǒng  
postbox



信箱  
xìnxiāng  
letterbox



包裹  
bāoguǒ  
parcel



速递  
sùdì  
courier

## 电话 diànhuà • telephone

话机  
huàjī  
handset

机座  
jīzuò  
base station



无绳电话  
wúshéng diànhuà  
cordless phone

答录机  
dálùjī  
answering machine



可视电话  
kěshìdiànhuà  
video phone



电话亭  
diànhuàtíng  
telephone box



移动电话  
yí dòng diànhuà  
mobile phone

按键区  
ànjiànqū  
keypad

听筒  
tīngtǒng  
receiver

退币口  
tuìbīkǒu  
coin return



投币电话  
tóubìdiànhuà  
coin phone



磁卡电话  
cíkǎdiànhuà  
card phone

## 词汇 cíhuì • vocabulary

电话号码查询台  
diànhuàhào mǎcháxúntái  
directory enquiries

接听电话  
jiē tīng diànhuà  
answer (v)

接线员  
jiē xiàn yuán  
operator

你能告诉我...的号码吗?  
nǐ néng gào sù wǒ...de hào mǎ ma?  
Can you give me the number for...?

对方付费电话  
duì fāng fù fèi diànhuà  
reverse charge call

文字讯息  
wén zì xùn xī  
text message

占线  
zhàn xiàn  
engaged/busy

...的拨叫号码是多少?  
...de bō jiào hào mǎ shì duō shǎo?  
What is the dialling code for...?

拨号  
bō hào  
dial (v)

语音讯息  
yǔ yīn xùn xī  
voice message

断线  
duàn xiàn  
disconnected

# 旅馆 lǚguǎn • hotel

## 大厅 dàitīng • lobby



接待总台 jiēdài zǒngtái | reception



搬运工 bānyùngōng | porter

行李 xíngli  
luggage

行李车 xínglichē  
trolley



电梯 diàntī | lift



房间号码 fángjiān hàomǎ  
room number

## 房间 fángjiān • rooms



单人间 dānrénjiān  
single room



双人间 shuāngrénjiān  
double room



标准间 biāozhǔnjiān  
twin room



专用浴室 zhuān yòngyùshì  
private bathroom



服务 fúwù • services



客房清洁服务  
kèfáng qīngjié fúwù  
maid service



洗衣服务  
xǐyī fúwù  
laundry service

早餐盘

zǎocānpán  
breakfast tray



房间送餐服务 fángjiān sòngcān fúwù | room service



小冰箱  
xiǎobīngxiāng  
mini bar



餐厅  
cāntīng  
restaurant



健身房  
jiànshēnfáng  
gym



游泳池  
yóuyǒngchí  
swimming pool

词汇 cíhuì • vocabulary

提供住宿和早餐  
tígōng zhùsù hé zǎocān  
bed and breakfast

供应三餐  
gōngyīng sāncān  
full board

半食宿  
bànshíù  
half board

有空房间吗？  
yǒu kōng fángjiān ma?  
Do you have any vacancies?

我预定了房间。  
wǒ yùdìng le fángjiān.  
I have a reservation.

我想要一个单人间。  
wǒ xiǎngyào yīgè dānrénjiān,  
I'd like a single room.

我要一个房间，住三天。  
wǒ yào yīgè fángjiān, zhù sāntiān.  
I'd like a room for three nights.

住一晚多少钱？  
zhù yíwǎn duōshǎoqián?  
What is the charge per night?

我什么时候得腾房？  
wǒ shénme shíhòu děi téng fáng?  
When do I have to vacate the room?









购物 gòuwù  
shopping



# 购物中心 gòuwùzhōngxīn • shopping centre

大厅  
dàtīng  
atrium

招牌  
zhāopái  
sign

电梯  
diàntī  
lift



三层  
sāncéng  
second floor

二层  
èrcéng  
first floor

自动扶梯  
zìdòng fútī  
escalator

一层  
yīcéng  
ground floor

顾客  
gùkè  
customer

## 词汇 cíhuì • vocabulary

儿童用品部  
értóng yòngpǐnbù  
children's department

购物指南  
gòuwù zhǐnán  
store directory

更衣室  
gēngyīshì  
changing rooms

这个多少钱？  
zhège duōshǎo qián?  
How much is this?

箱包部  
xiāngbāobù  
luggage department

售货员  
shòuhuòyuán  
sales assistant

婴儿间  
yīngérjiān  
baby changing facilities

我可以换一件吗？  
wǒ kěyǐ huàn yījiàn ma?  
May I exchange this?

鞋靴部  
xiéxuēbù  
shoe department

客户服务  
kèhù fúwù  
customer services

卫生间  
wèishēngjiān  
toilets

百货商店 bǎihuò shāngdiàn • department store



男装  
nánzhuāng  
men's wear



女装  
nǚzhuāng  
women's wear



女用内衣  
nǚyòng nèiyī  
lingerie



香水  
xiāngshuǐ  
perfumery



美容用品  
měiróng yòngpǐn  
beauty



家用纺织品  
jiāyòng fāngzhǐpǐn  
linen



家具  
jiājù  
home furnishings



缝纫用品  
féngrièn yòngpǐn  
haberdashery



厨房用品  
chúfáng yòngpǐn  
kitchenware



瓷器  
cíqì  
china



电子产品  
diànzǐ chǎnpǐn  
electrical goods



灯具  
dēngjù  
lighting



体育用品  
tǐyù yòngpǐn  
sports



玩具  
wánjù  
toys



文具  
wénjù  
stationery



食品  
shípǐn  
food hall



# 超级市场 chāojí shìchǎng • supermarket

过道  
guòdào  
aisle

货架  
huòjiǎ  
shelf

传送带  
chuánsòngdài  
conveyer belt

收银员  
shōuyínyuán  
cashier

促销海报  
cùxiāo hǎibào  
offers



收款台 shōukuǎntái | checkout

顾客  
gùkè  
customer

收款机  
shōukuǎnjī  
till

购物袋  
gòuwùdài  
shopping bag



购物车 gòuwùchē | trolley

食品杂货  
shípín zǎhuò  
groceries

提手  
tíshǒu  
handle



购物篮 gòuwùlán | basket



条形码  
tiáoxíngmǎ  
bar code



条形码扫描器 tiáoxíngmǎ  
sàomiáoque | scanner



烘烤食品  
hōngkǎo shípín  
bakery



乳制品  
rǔzhǐpǐn  
dairy



早餐麦片  
zǎocān màipiàn  
breakfast cereals



罐装食品  
guǎnzhuāng shípín  
tinned food



甜食  
tiánshí  
confectionery



蔬菜  
shūcài  
vegetables



水果  
shuǐguǒ  
fruit



肉禽  
ròuqín  
meat and poultry

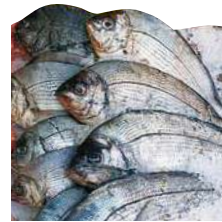

鱼  
yú  
fish



熟食  
shúshí  
deli



冷冻食品  
lěngdòng shípín  
frozen food



方便食品  
fāngbiàn shípín  
convenience food



饮料  
yǐnliào  
drinks



家庭日用品  
jiāting rìyòngpǐn  
household products



化妆品  
huàzhuāngpǐn  
toiletries



婴儿用品  
yīng'ér yòngpǐn  
baby products



家用电器  
jiāyòng diànjī  
electrical goods



宠物饲料  
chǒngwù siliào  
pet food



杂志 zázhi | magazines



# 药店 yàodiàn • chemist





胶囊  
jiāonáng  
capsule



药片  
yàopiàn  
pill

量匙  
liàngchí  
measuring spoon



糖浆  
tángjiāng  
syrup

使用说明  
shǐyòng shuōmíng  
instructions



吸入器  
xīrùqì  
inhaler



霜剂  
shuāngjì  
cream



软膏  
ruǎngāo  
ointment



凝胶  
níngjiāo  
gel



栓剂  
shuānjì  
suppository



滴剂  
dījì  
drops



注射器  
zhùshèqì  
syringe

滴管  
dīguǎn  
dropper

针头  
zhēntóu  
needle



喷雾器  
pēnwùqì  
spray



散剂  
sǎnjì  
powder

词汇 cíhuì • vocabulary

铁  
tiě  
iron

胰岛素  
yídǎosù  
insulin

一次性的  
yíxíngde  
disposable

药  
yào  
medicine

止痛药  
zhǐtòngyào  
painkiller

钙  
gài  
calcium

副作用  
fùzuòyòng  
side-effects

可溶解的  
kěróngjiěde  
soluble

泻药  
xièyào  
laxative

镇静剂  
zhènjìngjì  
sedative

镁  
měi  
magnesium

有效期限  
yǒuxiàoxiàn  
expiry date

剂量  
jìliàng  
dosage

腹泻  
fùxiè  
diarrhoea

安眠药  
ānmínyào  
sleeping pill

多种维生素制剂  
duōzhǒng  
wéishēngsù zhìjì  
multivitamins

晕车药  
yùncēyào  
travel sickness pills

药物治疗  
yàowù zhìliáo  
medication

润喉片  
rùnhóupiàn  
throat lozenge

消炎药  
xiāoyányào  
anti-inflammatory



# 花店 huādiàn • florist

花  
huā  
flowers

百合  
bǎihé  
lily

洋槐  
yánghuái  
acacia

康乃馨  
kāngnǎixīn  
carnation

盆栽植物  
pénzāi zhíwù  
pot plant



剑兰  
jiànlán  
gladiolus

鸢尾  
yuānwěi  
iris

雏菊  
chújú  
daisy

菊花  
júhuā  
chrysanthemum

满天星  
mǎntiānxīng  
gypsophila



紫罗兰  
zǐluólán  
stocks



非洲菊  
fēizhōujú  
gerbera



叶簇  
yècù  
foliage



玫瑰  
méiguī  
rose



小苍兰  
xiǎocānglán  
freesia

## 插花 chāhuā • arrangements

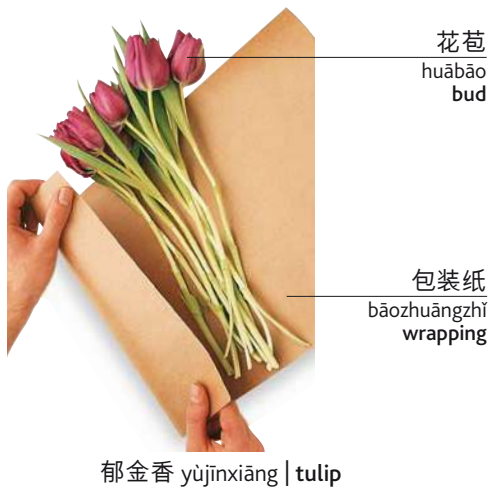
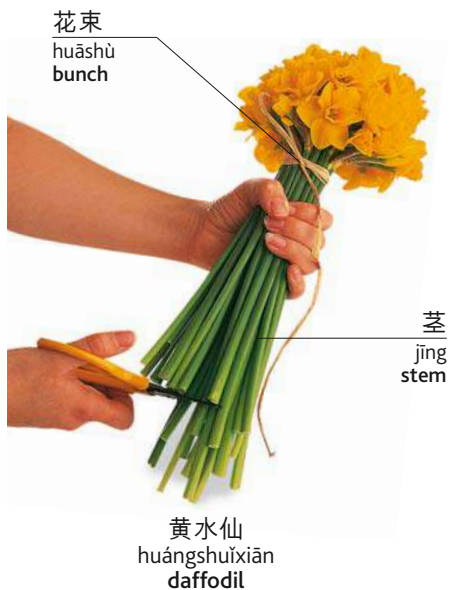
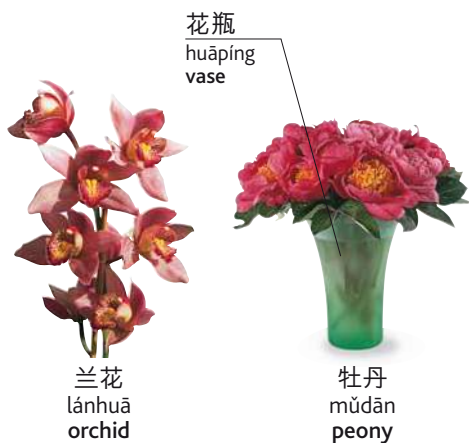

我能附上留言吗？  
wǒ néng fùshàng liúyán ma?  
Can I attach a message?

能帮我包一下吗？  
néng bāng wǒ bāo yíxià ma?  
Can I have them wrapped?

能不能将它们送到...？  
néngbùnéng jiāng tāmen  
sòngdào...?  
Can you send them to....?

这些花能开多久？  
zhèxiē huā néng kāi duōjiǔ?  
How long will these last?

这些花香吗？  
zhèxiē huā xiāng ma?  
Are they fragrant?

我想买一束...  
wǒ xiǎng mǎi yíshù...  
Can I have a bunch of... please.



# 报刊亭 bàokāntíng • newsagent



香烟  
xiāngyān  
cigarettes

烟盒  
yānhé  
packet of cigarettes

火柴  
huǒchái  
matches

彩票, 奖券  
cǎipiào, jiǎngquàn  
lottery tickets

邮票  
yóupiào  
stamps



明信片  
míngxìnpìàn  
postcard



连环画  
liánhuánhuà  
comic



杂志  
zázhì  
magazine



报纸  
bàozhǐ  
newspaper

# 吸烟 xīyān • smoking



烟草  
yāncǎo  
tobacco



打火机  
dǎhuǒjī  
lighter



烟锅  
yānguō  
bowl

烟斗  
yāndǒu  
pipe

烟嘴  
yānzǔi  
stem



雪茄  
xuějiā  
cigar

## 糖果店 tángguǒdiàn • confectioner

巧克力盒

qiǎokèlìhé  
box of chocolates

零食

língshí  
snack bar

薯片

shǔpiàn  
crisps

甜食店 tiánshídiàn | sweet shop

## 词汇 cíhuì • vocabulary

牛奶巧克力  
niú'nǎiqiǎokèlì  
milk chocolate黑巧克力  
hēiqiǎokèlì  
plain chocolate白巧克力  
báiqiǎokèlì  
white chocolate杂拌糖果  
zábàntángguǒ  
pick and mix焦糖  
jiāotáng  
caramel巧克力球  
qiǎokèlìqiú  
truffle饼干  
bǐnggān  
biscuit硬糖  
yìngtáng  
boiled sweets

## 糖果 tángguǒ • confectionery

巧克力  
qiǎokèlì  
chocolate块状巧克力板  
kuàizhuàng qiǎokèlìbǎn  
chocolate bar糖果  
tángguǒ  
sweets棒棒糖  
bàngàngtáng  
lollipop

太妃糖 tàifēitáng | toffee

奶油杏仁糖  
nǎiyóuxíngréntáng | nougat棉花软糖  
miánhuāruǎntáng  
marshmallow薄荷糖  
bòhetáng  
mint口香糖  
kǒuxiāngtáng  
chewing gum软心豆粒糖  
ruǎnxīndòulìtáng  
jellybean果味橡皮糖  
guǒwèixiāngpítáng  
fruit gum甘草糖  
gāncǎotáng  
liquorice



# 其他店铺 qítā diànpù • other shops



面包店  
miànbāodiàn  
baker's



糕点店  
gāodiǎndiàn  
cake shop



肉铺  
ròupù  
butcher's



水产店  
shuǐchǎndiàn  
fishmonger's



蔬菜水果店  
shūcǎishuǐguǒdiàn  
greengrocer's



食品杂货店  
shípīnzáhùodiàn  
grocer's



鞋店  
xiédiàn  
shoe shop



五金店  
wǔjīndiàn  
hardware shop



古董店  
gǔdǒngdiàn  
antiques shop



礼品店  
lǐpǐndiàn  
gift shop



旅行社  
lǚxíngshè  
travel agent's



首饰店  
shǒushìdiàn  
jeweller's





书店  
shūdiàn  
book shop



音像店  
yīnxiàngdiàn  
record shop



酒类专卖店  
jiǔlèizhuānmài diàn  
off licence



宠物商店  
chǒngwùshāngdiàn  
pet shop



家具店  
jiājùdiàn  
furniture shop



时装店  
shízhuāngdiàn  
boutique

词汇 cíhuì • vocabulary

房地产商  
fángdìchǎnshāng  
estate agent's

照相器材店  
zhàoxiàng qìcái diàn  
camera shop

园艺用品店  
yuányì yòngpǐndiàn  
garden centre

绿色食品店  
lǜsèshípǐndiàn  
health food shop

干洗店  
gānxǐdiàn  
dry cleaner's

艺术品店  
yìshùpǐndiàn  
art shop

投币式自动洗衣店  
tóubìshì zìdòngxǐyīdiàn  
launderette

旧货商店  
jiùhuò shāngdiàn  
second-hand shop



裁缝店  
cáifēngdiàn  
tailor's



美发厅  
měifātīng  
hairdresser's



市场 shìchǎng | market





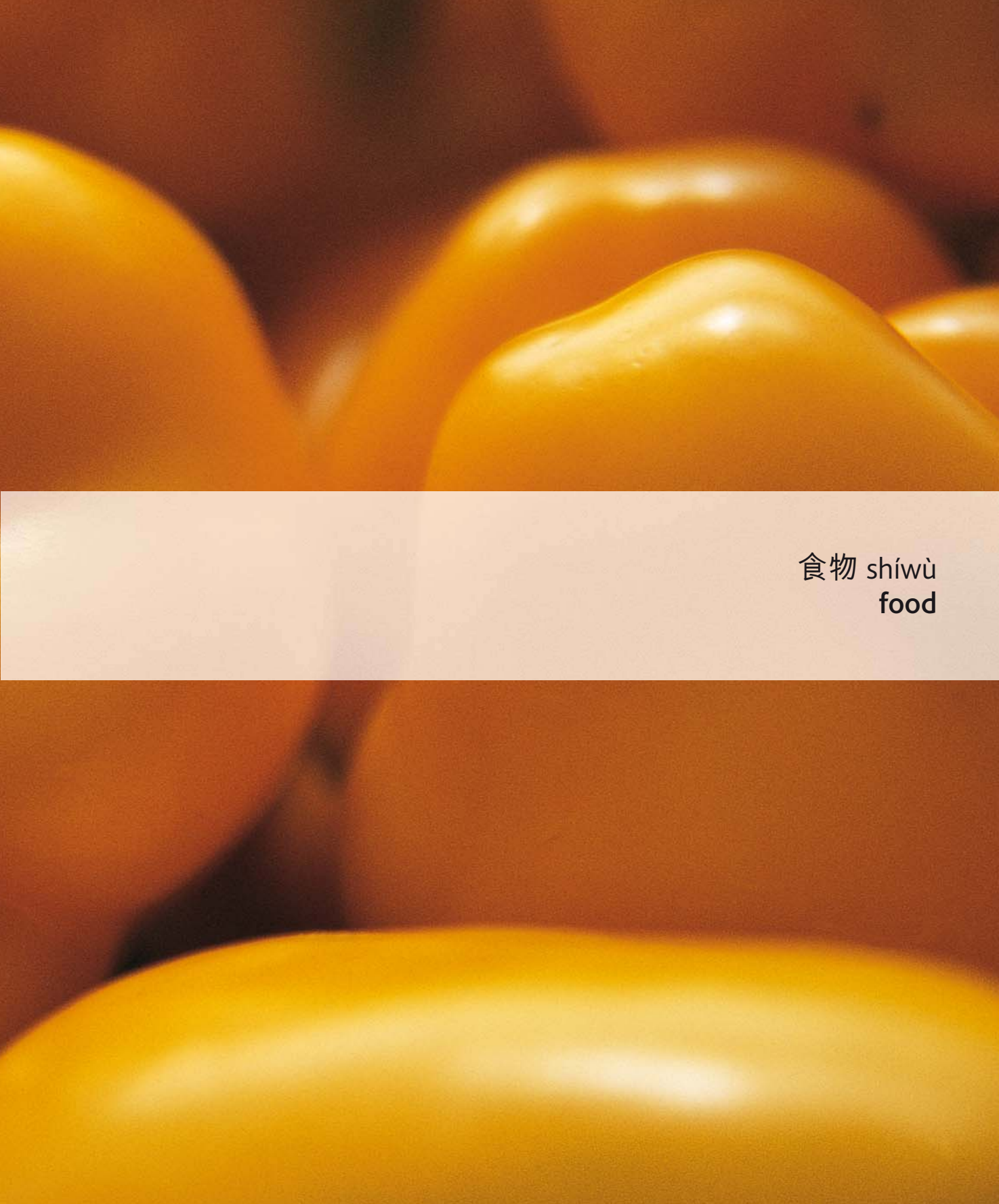

食物 shíwù  
food



# 肉 ròu • meat



羔羊肉  
gāoyángròu  
lamb

肉店老板  
ròudiànlaobǎn  
butcher

吊肉钩  
diàoròugōu  
meat hook

秤  
chèng  
scales

磨刀器  
módaoqì  
knife sharpener

熏肉  
xūnròu  
bacon

香肠  
xiāngcháng  
sausages

肝脏  
gānzàng  
liver

## 词汇 cíhuì • vocabulary

猪肉  
zhūròu  
pork

野味肉  
yěwèiròu  
venison

下水  
xiàshuǐ  
offal

放养的  
fàngyǎngde  
free range

熟肉  
shúròu  
cooked meat

牛肉  
niúròu  
beef

兔肉  
tùròu  
rabbit

腌制的  
yānzhide  
cured

有机(饲养)的  
yǒuji(siyǎng)de  
organic

白肉 (指家禽肉、鱼肉等)  
báiròu (zhǐjiāqīnròu, yúròuděng)  
white meat

小牛肉  
xiǎoniúròu  
veal

牛舌  
niúshé  
tongue

熏制的  
xūnzhide  
smoked

瘦肉  
shòuròu  
lean meat

红肉(指牛肉、猪肉和羊肉)  
hóngròu (zhǐniúròu, zhūròuhéyángòu)  
red meat

切块 qiēkuài • cuts

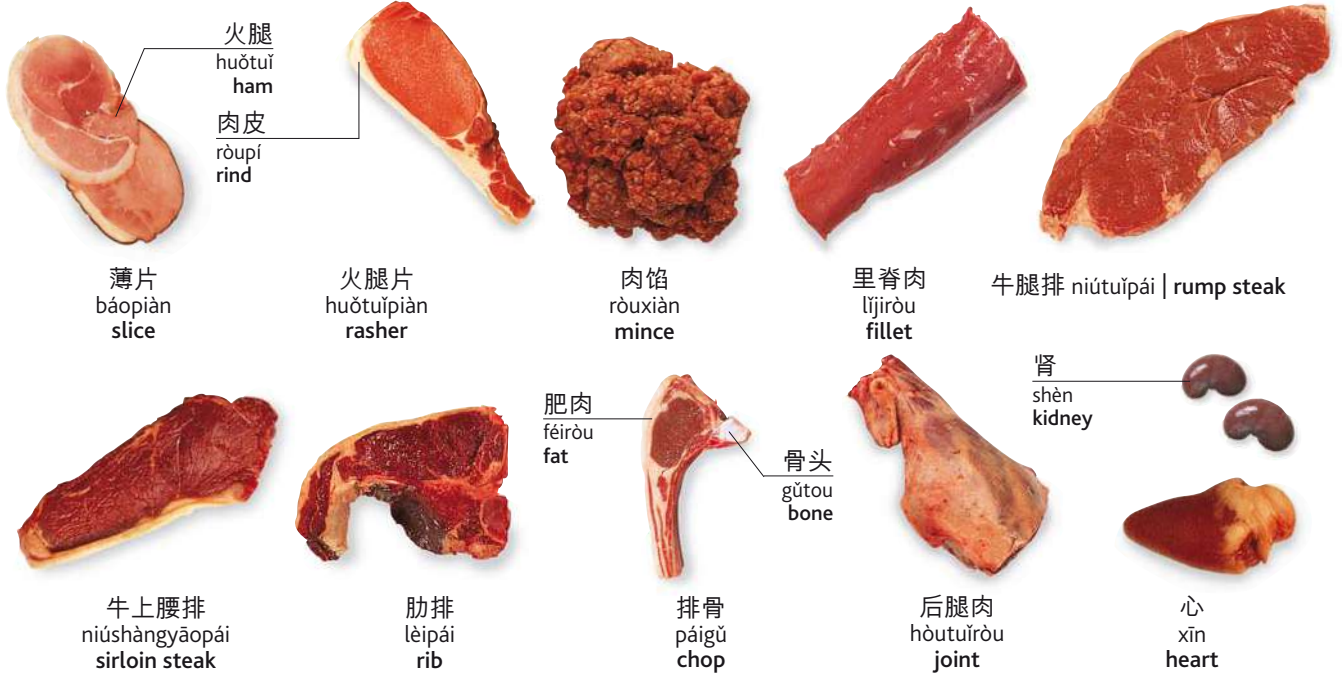

禽肉 qínròu • poultry

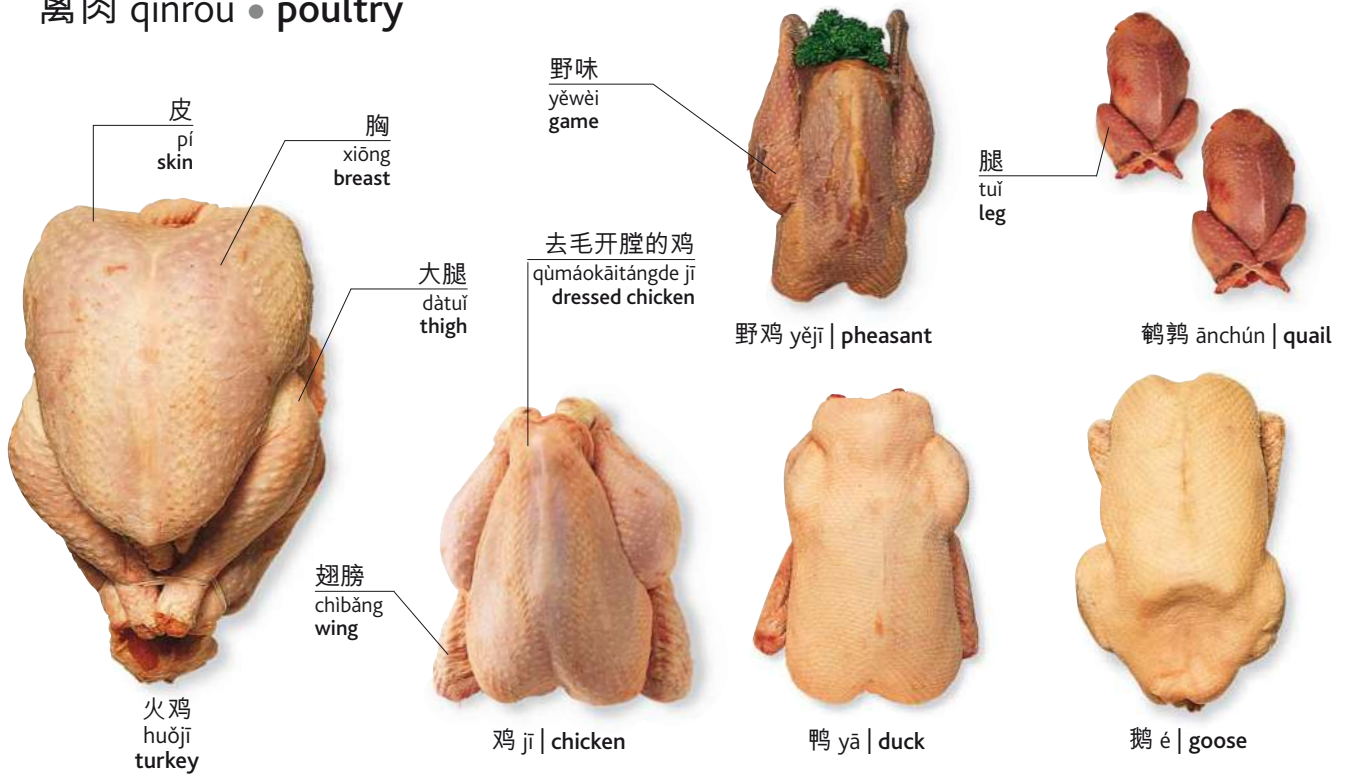



# 鱼 yú • fish

去皮虾  
qùpíxiā  
peeled prawns

冰  
bīng  
ice

羊鱼  
yángyú  
red mullet

大比目鱼片  
dàbǐmùyúpiàn  
halibut fillets

虹鳟鱼  
hóngzūnyú  
rainbow trout

鳐鱼翅  
yáoyúchì  
skate wings

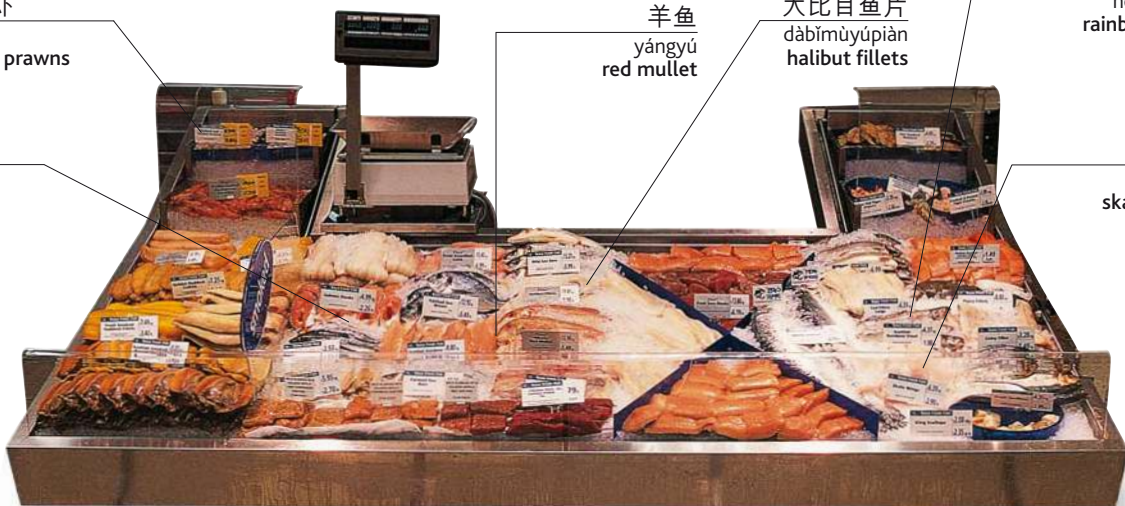

水产店  
shuǐchǎndiàn  
fishmonger's



鳐鱼  
ānkāngyú  
monkfish



鲭鱼  
qīngyú  
mackerel



鳟鱼  
zūnyú  
trout



剑鱼  
jiànyú  
swordfish



鲳鱼  
tǎiyú  
Dover sole



黄盖鲽  
huánggàidí  
lemon sole



黑线鳕  
hēixiànxuē  
haddock



沙丁鱼  
shādīngyú  
sardine



鳐鱼  
yáoyú  
skate



牙鳕  
yáxuē  
whiting



海鲈  
hǎilú  
sea bass



鲑鱼  
guīyú | salmon



鳕鱼  
xuēyú  
cod



鲷鱼  
diāoyú  
sea bream



金枪鱼  
jīnqiāngyú  
tuna

# 海鲜 hǎixiān • seafood

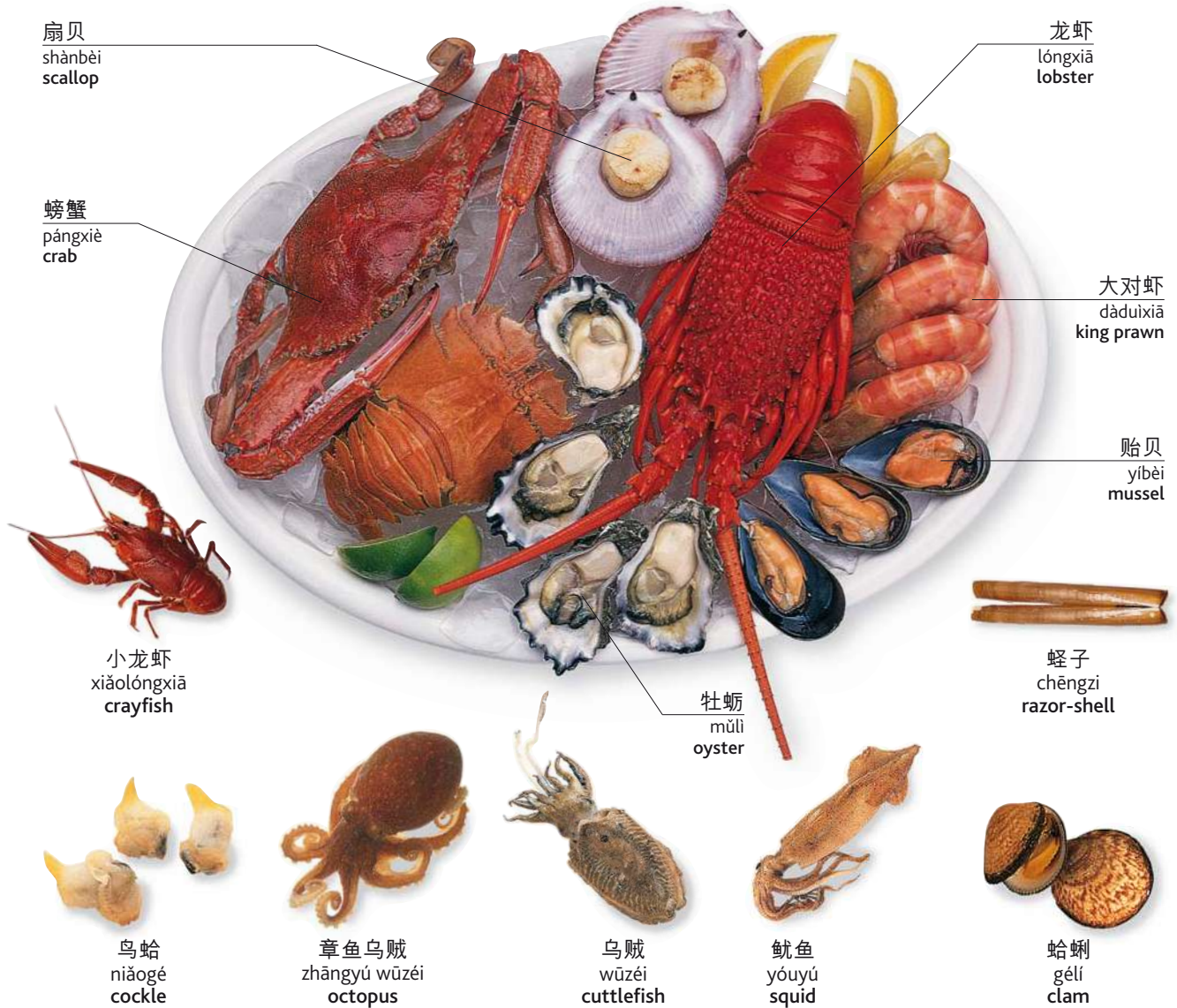

## 词汇 cíhuì • vocabulary

冷冻的  
lěngdòngde  
frozen

盐渍的  
yánzide  
salted

熏制的  
xūnzhide  
smoked

去鳞的  
qùlín de  
descaled

去骨鱼片  
qùgǔyúpiàn  
fillet

腰肉  
yāoròu  
loin

尾部  
wěibù  
tail

骨头  
gūtou  
bone

鳞片  
línpiàn  
scale

新鲜  
xīnxiān  
fresh

处理干净的  
chǔlǐgān  
jìngde  
cleaned

去皮的  
qùpíde  
skinned

去骨的  
qùgǔde  
boned

切片的  
qiēpiàn de  
filleted

鱼片  
yúpiàn  
steak

能帮我把它收拾干净吗?  
néng bāng wǒ bǎ tā shōushi gānjìng ma?  
Will you clean it for me?



# 蔬菜1 shūcài yī • vegetables 1

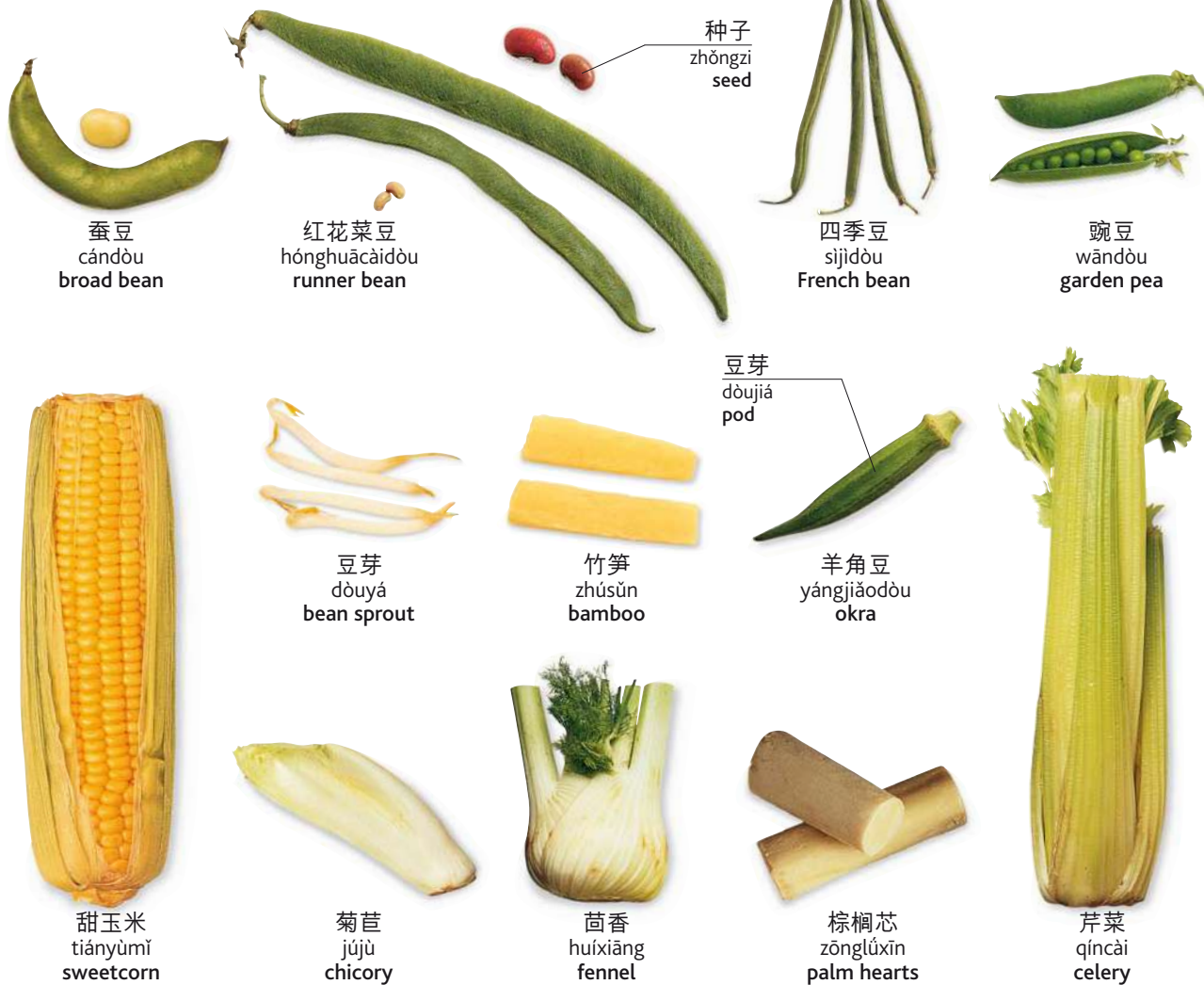

## 词汇 cíhuì • vocabulary

叶 yè  
leaf

小花 xiǎohuā  
florete

尖 jiān  
tip

有机(栽培)的 yǒuji(zāipéi)de  
organic

这儿卖有机蔬菜吗?  
zhè'er mài yǒujīshūcài ma?  
Do you sell organic vegetables?

菜梗 cài gěng  
stalk

果仁 guǒrén  
kernel

芯 xīn  
heart

塑料袋 sùliàodài  
plastic bag

这些是当地产的吗?  
zhèxiē shì dāngdìchǎnde ma?  
Are these grown locally?



芝麻菜  
zhīmá cài  
rocket



豆瓣菜  
dòubàn cài  
watercress



红球菊苣  
hóngqiú jújú  
radicchio



抱子甘蓝  
bào zǐ gān lán  
Brussels sprouts



甜叶菜  
tiányè cài  
Swiss chard



羽衣甘蓝  
yǔyī gān lán  
kale



酸模  
suān mó  
sorrel



苦苣  
kǔ jú  
endive



蒲公英  
púgōng yīng  
dandelion



菠菜  
bō cài  
spinach



球茎甘蓝  
qiújīng gān lán  
kohlrabi



油菜  
yóu cài  
pak-choi



莴苣  
wō jú  
lettuce



西兰花  
xī lán huā  
broccoli



卷心菜  
juǎn xīn cài  
cabbage



嫩圆白菜  
nèn yuán bái cài  
spring greens



# 蔬菜2 shūcài'èr • vegetables 2



## 词汇 cíhuì • vocabulary

樱桃番茄  
yīngtáofānqié  
cherry tomato

块根芹  
kuàigēnqín  
celeriac

冷冻的  
lěngdòngde  
frozen

苦  
kǔ  
bitter

请给我一公斤马铃薯。  
qǐng gěi wǒ yì gōngjīn mǎlǐngshǔ.  
Can I have one kilo of potatoes please?

胡萝卜  
húluóbo  
carrot

芋头  
yùtóu  
taro root

生  
shēng  
raw

硬  
yìng  
firm

每公斤多少钱？  
měi gōngjīn duōshǎo qián?  
What's the price per kilo?

面包果  
miànbāoguǒ  
breadfruit

木薯  
mùshǔ  
cassava

辣  
là  
hot (spicy)

果肉  
guǒròu  
flesh

那些叫什么？  
nàxiē jiào shēnme?  
What are those called?

嫩马铃薯  
nènmǎlǐngshǔ  
new potato

荸荠  
bíqí  
water chestnut

甜  
tián  
sweet

根  
gēn  
root



红薯  
hóngshǔ  
sweet potato



山药  
shānyào  
yam



甜菜  
tiāncài  
beetroot



芜菁甘蓝  
wújīngānlán  
swede



菊芋  
júyù  
Jerusalem artichoke



辣根菜  
làgēncài  
horseradish



欧洲防风根  
ōuzhōufāngfēnggēn  
parsnip



姜  
jiāng  
ginger



茄子  
qiézi  
aubergine



番茄  
fānqié  
tomato



葱  
cōng  
spring onion



韭葱  
jiǔcōng  
leek



葱头  
cōngtóu  
shallot



大蒜  
dàsuàn  
garlic

蒜瓣儿  
suàn bàn' er  
clove



蘑菇  
mógū  
mushroom

块菌  
kuàijūn  
truffle

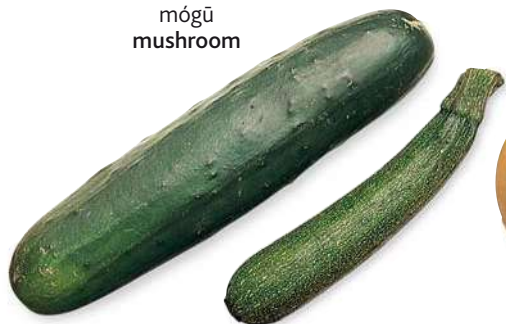

黄瓜  
huángguā  
cucumber

密生西葫芦  
mìshēngxīhúlu  
courgette



冬南瓜  
dōngnánguā  
butternut squash



橡果  
xiàngguǒ  
acorn squash



南瓜  
nánguā  
pumpkin



# 水果1 shuǐguǒ yī • fruit 1

## 柑橘类水果 gānjú lèishuǐguǒ • citrus fruit



橘子  
júzi  
orange



细皮小柑橘  
xìpíxiǎogānjú  
clementine



牙买加丑橘  
yámǎijiǎchǒujú  
ugli fruit

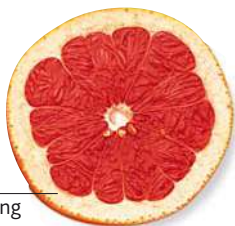

海绵层  
hǎimiáncéng  
pith

葡萄柚  
pútáoyòu  
grapefruit



橘瓣儿  
júbànr  
tangerine

橘瓣儿  
júbànr  
segment



无核蜜橘  
wúhémìjú  
satsuma



酸橙  
suānchéng  
lime

外皮  
wàipí  
zest



柠檬  
níngméng  
lemon



金橘  
jīnjú  
kumquat

## 有核水果 yǒuhéshuǐguǒ • stoned fruit



桃  
táo  
peach



油桃  
yóutáo  
nectarine



杏  
xìng  
apricot



李子  
lǐzi  
plum



樱桃  
yīngtáo  
cherry

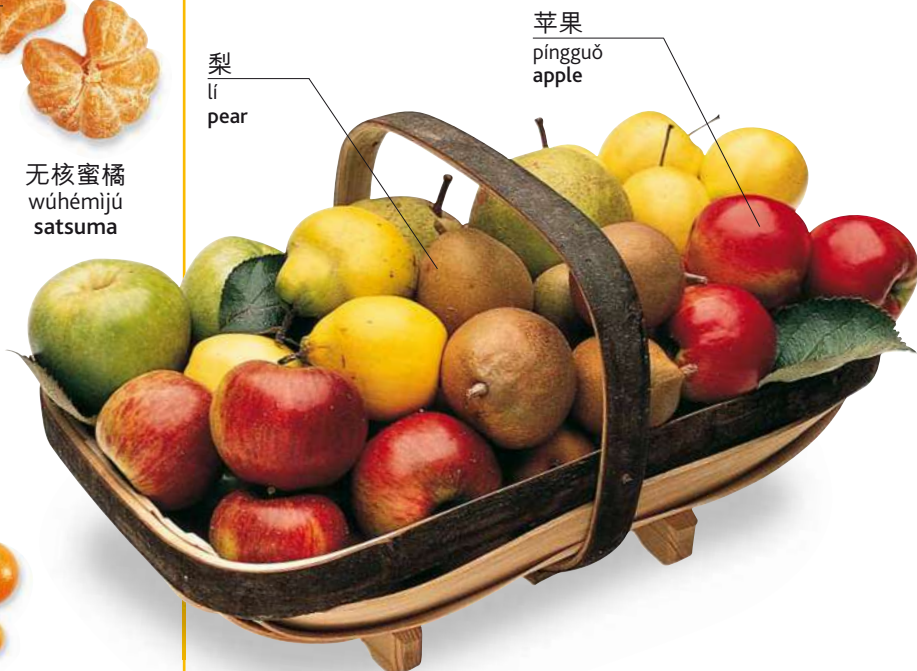

梨  
lí  
pear

苹果  
píngguǒ  
apple

果篮 guǒlán | basket of fruit

浆果和甜瓜 jiāngguǒ hé tiánguā • berries and melons



草莓  
cǎoméi  
strawberry



覆盆子  
fùpénzi  
raspberry



甜瓜  
tiánguā  
melon



葡萄  
pútáo  
grapes



黑莓  
hēiméi  
blackberry



红醋栗  
hóngcùlì  
redcurrant



蔓越橘  
mànyuèjú  
cranberry



黑醋栗  
hēicùlì  
blackcurrant

瓜皮  
guāpí  
rind

瓜籽  
guāzǐ

瓜瓤  
guāráng  
flesh



蓝莓  
lánméi  
blueberry



白醋栗  
báicùlì  
white currant

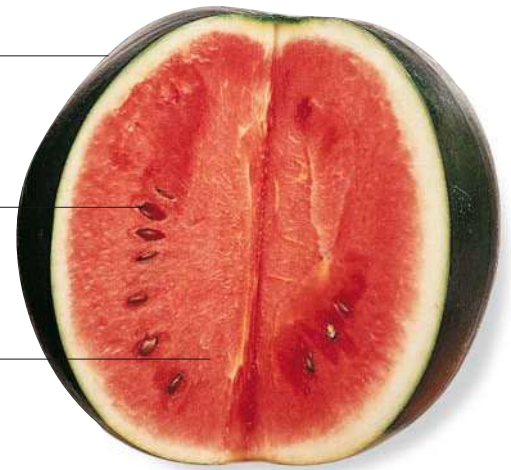

西瓜  
xīguā  
watermelon



罗甘莓  
luógānméi  
loganberry



醋栗  
cùlì  
gooseberry

词汇 cíhuì • vocabulary

大黄  
dàhuáng  
rhubarb

酸  
suān  
sour

脆  
cuì  
crisp

汁液  
zhīyè  
juice

它们熟吗？  
tāmen shú ma?  
Are they ripe?

纤维  
xiānwéi  
fibre

新鲜  
xīnxiān  
fresh

烂  
làn  
rotten

核  
hé  
core

我可以尝一个吗？  
wǒ kěyǐ cháng yigè ma?  
Can I try one?

甜  
tián  
sweet

多汁  
duōzhī  
juicy

果肉  
guǒròu  
pulp

无核  
wúhé  
seedless

它们能放多久？  
tāmen néng fàng duōjiǔ?  
How long will they keep?



# 水果2 shuǐguǒ 2 • fruit 2

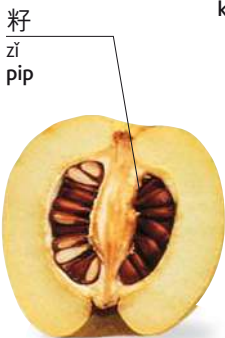

榲桲  
yùnbó  
quince



西番莲果  
xīfānliánguǒ  
passion fruit

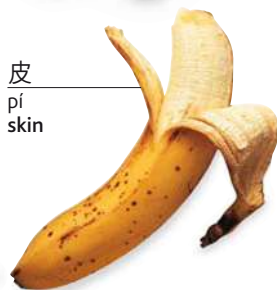

香蕉  
xiāngjiāo  
banana



番石榴  
fānshíliú  
guava



石榴  
shíliú  
pomegranate



柿子  
shìzi  
persimmon



费约果  
fèiyuēguǒ  
feijoa



仙人掌果  
xiānrénzhǎngguǒ  
prickly pear



杨桃  
yángtáo  
starfruit



山竹果  
shānzhúguǒ  
mangosteen

坚果和干果 jiānguǒ hé gānguǒ • nuts and dried fruit



松子  
sōngzǐ  
pine nut



开心果  
kāixīnguǒ  
pistachio



腰果  
yāoguǒ  
cashewnut



花生  
huāshēng  
peanut



榛子  
zhēnzi  
hazelnut



巴西果  
bāxiguǒ  
brazil nut



美洲山核桃  
měizhōushānhétào  
pecan



杏仁  
xīngrén  
almond



核桃  
hétào  
walnut



栗子  
lizi  
chestnut



澳洲坚果  
àozhōujiānguǒ  
macadamia



无花果  
wúhuāguǒ  
fig



椰枣  
yēzǎo  
date



梅干  
méigān  
prune

壳  
ké  
shell



果肉  
guǒròu  
flesh



无核葡萄干  
wúhépútáogān  
sultana



葡萄干  
pútáogān  
raisin



无核小葡萄干  
wúhéxiǎopútáogān  
currant

椰子  
yēzi  
coconut

词汇 cíhuì • vocabulary

未熟的  
wèishúde  
green

硬  
yìng  
hard

果仁  
guǒrén  
kernel

盐渍的  
yánzide  
salted

烘烤的  
hōngkǎode  
roasted

去壳的  
qùkéde  
shelled

蜜饯  
mìjiàn  
candied fruit

成熟的  
chéngshúde  
ripe

软  
ruǎn  
soft

脱水的  
tuōshuide  
desiccated

生  
shēng  
raw

应季的  
yìngjide  
seasonal

完整  
wánzhěng  
whole

热带水果  
rèdàishuǐguǒ  
tropical fruit



# 谷物及豆类 gǔwùjídòulèi • grains and pulses

## 谷物 gǔwù • grains



小麦  
xiǎomài  
wheat



燕麦  
yànmài  
oats



大麦  
dàmài  
barley



小米  
xiǎomǐ  
millet



玉米  
yùmǐ  
corn



奎奴亚藜  
kuínúyálí  
quinoa

### 词汇 cíhuì • vocabulary

种子  
zhǒngzi  
seed

香  
xiāng  
fragranced

易烹调的  
yìpēngtiáode  
easy cook

外壳  
wàiké  
husk

谷类食品  
gǔlèishípín  
cereal

长粒  
chánglì  
long-grain

谷粒  
gǔlì  
kernel

整粒  
zhěnglì  
wholegrain

圆粒  
yuánlì  
short-grain

干燥  
gānzào  
dry

浸泡  
jìnpào  
soak (v)

新鲜  
xīnxiān  
fresh

## 米 mǐ • rice



白米  
báimǐ  
white rice



糙米  
cāomǐ  
brown rice



菰米  
gūmǐ  
wild rice



布丁米  
bùdīngmǐ  
pudding rice

## 加工过的谷物 jiāgōngguòde gǔwù • processed grains



蒸粗麦粉  
zhēngcūmàifěn  
couscous



碎粒小麦  
suìlìxiǎomài  
cracked wheat



粗粒小麦粉  
cūlìxiǎomàifěn  
semolina



麦麸  
màifū  
bran

豆类 dòulèi • beans and peas



棉豆  
miándòu  
butter beans



菜豆  
càidòu  
haricot beans



红芸豆  
hóngyúndòu  
red kidney beans



赤豆  
chìdòu  
aduki beans



蚕豆  
cándòu  
broad beans



大豆  
dàdòu  
soya beans



黑眼豆  
hēiyǎndòu  
black-eyed beans



斑豆  
bāndòu  
pinto beans



绿豆  
lǜdòu  
mung beans



小(粒)菜豆  
xiǎo(li)càidòu  
flageolet beans



褐色小扁豆  
hèsèxiǎobiǎndòu  
brown lentils



红豆  
hóngdòu  
red lentils



青豆  
qīngdòu  
green peas



鹰嘴豆  
yīngzuǐdòu  
chick peas



半粒豆  
bànlìdòu  
split peas

种子 zhǒngzi • seeds



南瓜籽  
nánguāzǐ  
pumpkin seed



芥菜籽  
jiècǎizǐ  
mustard seed



葛缕子籽  
gélǚzǐ  
caraway



芝麻籽  
zhīmázi  
sesame seed



向日葵籽  
xiàngrikuízi  
sunflower seed



# 香草和香辛料 xiāngcǎo hé xiāngxīnliào • herbs and spices

## 香辛料 xiāngxīnliào • spices



香子兰 xiāngzǐlán | vanilla



肉豆蔻 ròudòukòu  
nutmeg



肉豆蔻衣 ròudòukòuyī  
mace



姜黄根 jiānghuángēn  
turmeric



枯茗, 小茴香 kūmíng, xiǎohuixiāng  
cumin



香料包 xiāngliàobāo  
bouquet garni



多香果 duōxiāngguǒ  
allspice



胡椒粒 hújiāoli  
peppercorn



葫芦巴 húlúbā  
fenugreek



辣椒末 làjiāomò  
chilli

颗粒状  
kēlìzhuàng  
whole

压碎的  
yāsuide  
crushed



藏红花 zànghónghuā  
saffron



小豆蔻 xiǎodòukòu  
cardamom



咖喱粉 gālífěn  
curry powder



磨碎的  
mósuide  
ground



辣椒粉 làjiāofěn  
paprika

片状  
piànzhàng  
flakes



大蒜 dàsuàn  
garlic

香草 xiāngcǎo • herbs

桂皮  
guìpí  
sticks



肉桂  
ròuguì  
cinnamon



柠檬草  
níngméngcǎo  
lemon grass



丁香  
dīngxiāng  
cloves



八角, 大料  
bājiǎo, dàliào  
star anise



姜  
jiāng  
ginger



茴香  
huixiāng  
fennel



细香葱  
xìxiāngcōng  
chives



龙蒿  
lónghāo  
tarragon



牛至  
niúzhì  
oregano

茴香籽  
huixiāngzǐ  
fennel seeds



薄荷  
bòhe  
mint



墨角兰  
mòjiǎolán  
marjoram



香菜  
xiāngcài  
coriander



月桂叶  
yuèguìyè  
bay leaf



百里香  
bǎilǐxiāng  
thyme



罗勒  
luólè  
basil



莳萝  
shíluó  
dill



欧芹  
ōuqín  
parsley



鼠尾草  
shǔwěicǎo  
sage



迷迭香  
mídiéxiāng  
rosemary



# 瓶装食品 píngzhuāngshípǐn • bottled foods



# 甜酱 tiánjiàng • sweet spreads



调味品 tiáowèipǐn • condiments and spreads



词汇 cíhuì • vocabulary

玉米油 yùmǐyóu corn oil

菜籽油 cài zǐ yóu rapeseed oil

花生油 huāshēngyóu groundnut oil

冷榨油 lěngzhà yóu cold-pressed oil

植物油 zhíwù yóu vegetable oil



# 乳制品 rǔzhìpǐn • dairy produce

## 奶酪 nǎilào • cheese

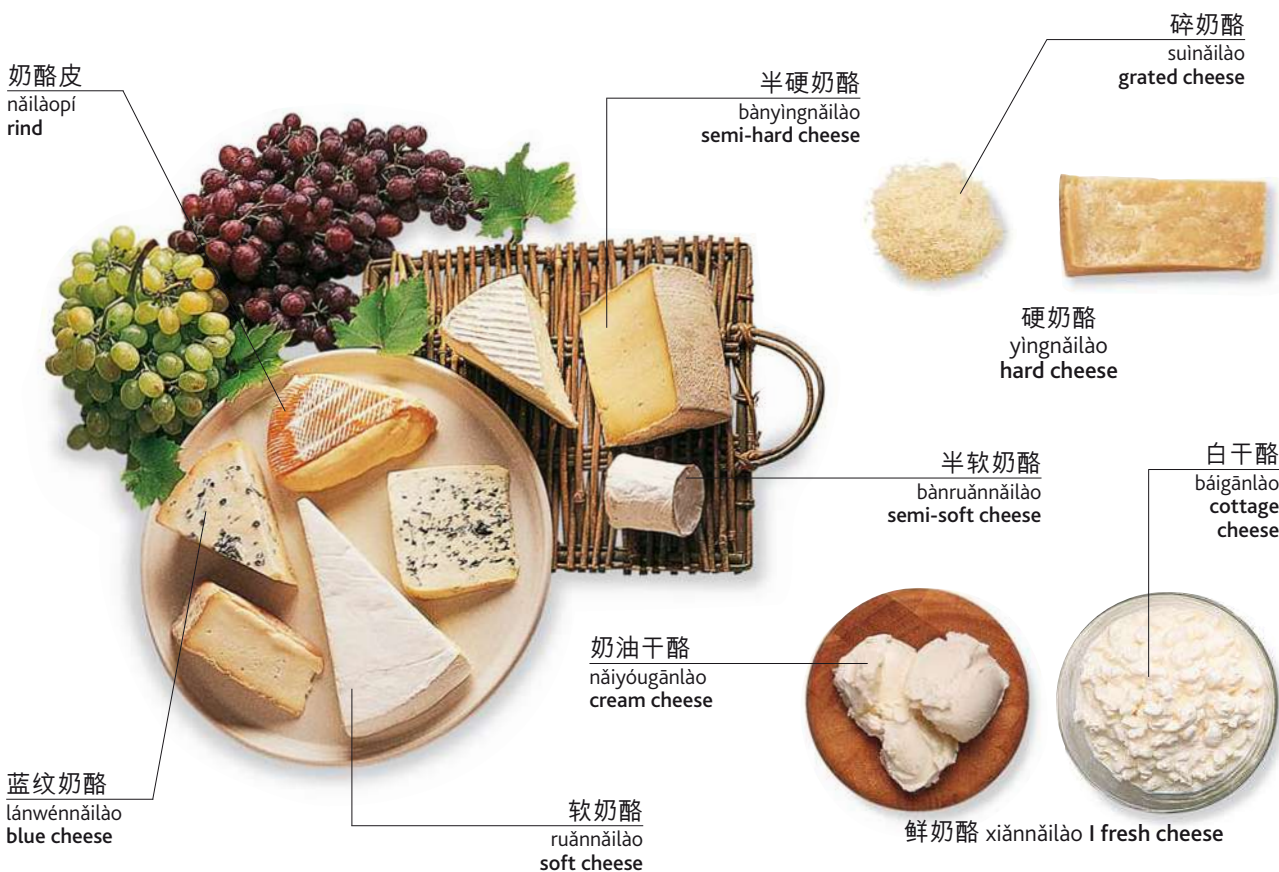

## 奶 nǎi • milk





黄油  
huángyóu  
butter



人造黄油  
rénzàohuángyóu  
margarine



奶油  
nǎiyóu  
cream



脱脂奶油  
tuōzhīnǎiyóu  
single cream



高脂肪奶油  
gāozhīfāngnǎiyóu  
double cream



搅奶油  
guǎnnǎiyóu  
whipped cream



酸奶油  
suānnǎiyóu  
sour cream



酸奶  
suānnǎi  
yoghurt



冰激凌  
bīngjīlíng  
ice-cream

## 蛋 dàn • eggs

蛋黄  
dànhuáng  
yolk

蛋白  
dànbái  
egg white

蛋壳  
dànké  
shell

蛋杯  
dànbēi  
egg cup

煮鸡蛋 zhǔjīdàn | boiled egg

鹅蛋  
édàn  
goose egg

鸡蛋  
jīdàn  
hen's egg

鸭蛋  
yādàn  
duck egg

鹌鹑蛋  
ānchúndàn  
quail egg

## 词汇 cíhuì • vocabulary

已经过巴氏消毒的  
yǐ jīngguò bāshìxiāodúde  
pasteurized

奶昔  
nǎixī  
milkshake

盐渍的  
yáncide  
salted

绵羊奶  
miányángnǎi  
sheep's milk

乳糖  
rǔtáng  
lactose

均质  
jūnzhì  
homogenised

未经过巴氏消毒的  
wèi jīngguò bāshìxiāodúde  
unpasteurized

冻酸奶  
dòngsuānnǎi  
frozen yoghurt

无盐的  
wúyánde  
unsalted

酪乳  
lǎorǔ  
buttermilk

不含脂肪的  
bùhánzhīfāngde  
fat free

奶粉  
nǎifěn  
powdered milk



# 面包和面粉 miànbāo hé miànfěn • breads and flours

切片面包  
qiēpiànmiànbāo  
sliced bread

罌粟籽  
yīngsùzǐ  
poppy seeds

黑面包  
hēimiànbāo  
rye bread

棍子面包  
gùnzi miànbāo  
baguette



面包店 miànbāodiàn | bakery

## 制作面包 zhìzuò miànbāo • making bread



精白面粉  
jīngbáimiànfěn  
white flour



黑麦面粉  
hēimàimiànfěn  
brown flour



全麦面粉  
quánmàimiànfěn  
wholemeal flour



酵母  
jiàomǔ  
yeast



筛撒 shāisǎ | sift (v)



搅拌 jiǎobàn | mix (v)

生面团  
shēng  
miàntuán  
dough



和面 huómian | knead (v)



烘制 hōngzhì | bake (v)



面包皮  
miànbāopí  
crust

白面包  
báimiànbāo  
white bread



面包块  
miànbāokuài  
loaf

黑面包  
hēimiànbāo  
brown bread



全麦面包  
quánmàimiànbāo  
wholemeal bread

切片  
qiēpiàn  
slice

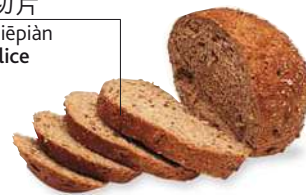

麸皮面包  
fūpímiànbāo  
granary bread



玉米面包  
yùmǐmiànbāo  
corn bread



苏打面包  
sūdàmiànbāo  
soda bread



酸面包  
suānmiànbāo  
sourdough bread



薄干脆饼  
báogāncuībǐng  
flatbread



硬面包圈，百吉饼  
yìngmiànbāoquān, bǎijībǐng  
bagel



软面包片  
ruǎnmiànbāopiàn | bap



小面包  
xiǎomiànbāo | roll



葡萄干面包  
pútáogānmiànbāo  
fruit bread



撒籽面包  
sǎzǐmiànbāo  
seeded bread



印度式面包  
yìndùshìmiànbāo  
naan bread



皮塔饼  
pítǎbǐng  
pitta bread



薄脆饼干  
báocuībǐnggān  
crispbread

词汇 cíhuì • vocabulary

高筋面粉  
gāojīnmiànfěn  
strong flour

发起  
fāqǐ  
rise (v)

发酵  
fājiào  
prove (v)

面包屑  
miànbāoxiè  
breadcrumbs

切片器  
qiēpiànqì  
slicer

自发粉  
zìfāfěn  
self-raising flour

中筋面粉  
zhōngjīnmiànfěn  
plain flour

浇糖  
jiāotáng  
glaze (v)

细长形面包  
xìchángxíngmiànbāo  
flute

面包师  
miànbāoshī  
baker



# 糕点 gāodiǎn • cakes and desserts

长条奶油夹  
心点心  
chángtiáo  
nǎiyóu jiāxīn  
diǎnxīn  
éclair

奶油  
nǎiyóu  
cream

夹心  
jiāxīn  
filling

油酥点心  
yóusūdiǎnxīn  
choux pastry

奶油泡芙  
nǎiyóupàofú  
puff pastry

夹心酥  
jiāxīnsū  
filo pastry



水果蛋糕  
shuǐguǒ dàngāo  
fruit cake

水果馅饼  
shuǐguǒ xiànbǐng  
fruit tart

蛋白甜饼  
dànbái tiánbǐng  
meringue

外覆巧克力  
wàifù qiǎokèlì  
chocolate coated

松饼  
sōngbǐng  
muffin

松糕  
sōnggāo  
sponge cake



蛋糕 dàngāo | cakes

## 词汇 cíhuì • vocabulary

奶油蛋糕  
nǎiyóu dàngāo  
crème pâtissière

小圆蛋糕  
xiǎoyuán dàngāo  
bun

面团  
miàntuán  
pastry

米饭布丁  
mǐfàn bùdīng  
rice pudding

我可以吃一片吗？  
wǒ kěyǐ chī yīpiàn ma?  
May I have a slice please?

巧克力蛋糕  
qiǎokèlì dàngāo  
chocolate cake

蛋奶糕  
dànnǎigāo  
custard

切片  
qiēpiàn  
slice

庆祝会  
qìngzhùhuì  
celebration

巧克力脆片  
qiǎokèlì cuipiàn  
chocolate chip



指形饼干  
zhǐxíng bǐnggān  
sponge fingers

果仁巧克力脆饼  
guǒrén qiǎokèlì  
cuībǐng  
florentine



蜜饯布丁  
mìjiàn bùdǐng  
trifle

饼干 bǐnggān | biscuits



奶油冻，慕思  
nǎiyóudòng, mùsī  
mousse



果汁冰糕  
guǒzhī bīnggāo  
sorbet



奶油馅饼  
nǎiyóu xiànbǐng  
cream pie



焦糖蛋奶  
jiāotáng dànǎi  
crème caramel

## 庆祝蛋糕 qìngzhù dàngāo • celebration cakes

顶层  
dǐngcéng  
top tier

底层  
dǐcéng  
bottom tier

杏仁糊  
xìngrénhú  
marzipan

缎带  
duàndài  
ribbon

糖霜  
tángshuāng  
icing



婚礼蛋糕 hūnlǐ dàngāo | wedding cake

装饰  
zhuāngshì  
decoration

生日蜡烛  
shēngrì làzhú  
birthday candles

吹熄  
chuīxī  
blow out (v)



生日蛋糕 shēngrì dàngāo | birthday cake



# 熟食店 shúshídiàn • delicatessen

辣香肠  
làxiāngcháng  
spicy sausage

油  
yóu  
oil



醋  
cù  
vinegar

生肉  
shēngròu  
uncooked meat

柜台  
guìtái  
counter

果酱饼  
guǒjiāngbǐng  
flan



萨拉米香肠  
sālāmǐ  
xiāngcháng  
salami

意大利辣香肠  
yìdàlì  
xiāngcháng  
pepperoni

肉酱  
ròujiāng  
pâté



莫泽雷勒干酪  
mòzéléilè gānlào  
mozzarella



布里干酪  
bùlǐ gānlào  
brie



山羊奶酪  
shānyáng nǎilào  
goat's cheese



切达干酪  
qiēdá gānlào  
cheddar



帕尔马干酪  
pà'ěrmǎ gānlào  
parmesan



卡门贝干酪  
kǎménbèi gānlào  
camembert

外皮  
wàipí  
rind



伊丹奶酪  
yīdānnǎilào  
edam



蒙切各干酪  
méngqiēgè gānlào  
manchego



西式馅饼, 派  
xīshì xiànbǐng, pài  
pies

小圆面包  
xiǎoyuán miànbāo  
bread roll

熟肉  
shúròu  
cooked meat

绿橄榄  
lǜgǎnlǎn  
green olive

火腿  
huǒtuǐ  
ham



黑橄榄  
hēigǎnlǎn  
black olive

辣椒  
làjiāo  
chili

酱  
jiàng  
sauce

三明治柜台 sānmíngzhì guìtái | sandwich counter



熏鱼  
xūnyú  
smoked fish



马槟榔  
mǎbīngláng  
capers



意大利熏火腿  
yìdàlì xūnhuǒtuǐ  
prosciutto

蒜味腊肠  
suànwèilācháng  
chorizo



填馅橄榄  
tiánxiàn gǎnlǎn  
stuffed olive

词汇 cíhuì • vocabulary

油渍  
yóuzi  
in oil

醋渍的  
cùzide  
marinated

熏制的  
xūnzhide  
smoked

卤制  
lǔzhi  
in brine

盐渍的  
yánzide  
salted

风干的  
fēnggānde  
cured

请拿一个号。  
qǐng ná yīgè hào.  
Take a number please.

我能尝尝吗？  
wǒ néng chángcháng ma?  
Can I try some of that please?

请来6片。  
qǐng lái liù piàn.  
May I have six slices of that please?



# 饮料 yǐnliào • drinks

## 水 shuǐ • water



## 热饮 rèyǐn • hot drinks



## 软(不含酒精的)饮料 ruǎn (bùhán jiǔjīngde) yǐnliào • soft drinks



含酒精饮料 hán jiǔjīng yǐnliào • alcoholic drinks



杜松子酒  
dùsōngzǐjiǔ | gin



啤酒  
píjiǔ  
beer

罐  
guàn  
can



苹果酒  
píngguǒjiǔ  
cider



苦啤酒  
kǔpíjiǔ  
bitter



浓烈黑啤酒  
nóngliè hēipíjiǔ  
stout



伏特加酒  
fú tè jiā jiǔ | vodka



威士忌 wēishìjī | whisky



朗姆酒  
lǎngmǔjiǔ  
rum



白兰地  
báilándì  
brandy



波尔图葡萄酒  
bōěrtú pútáojiǔ  
port



雪利酒  
xuélìjiǔ  
sherry

无糖份的  
wútángfēnde  
dry



堪培利酒  
kānpéilìjiǔ  
campari

玫瑰红(葡萄酒)  
méiguīhóng  
(pútáojiǔ)  
rosé (wine)

白(葡萄酒)  
bái (pútáojiǔ)  
white (wine)

红(葡萄酒)  
hóng  
(pútáojiǔ)  
red (wine)



利口酒  
lìkǒujiǔ  
liqueur



龙舌兰酒  
lóngshélánjiǔ  
tequila



香槟酒  
xiāngbīnjiǔ  
champagne



葡萄酒 pútáojiǔ | wine









外出就餐 wàichū jiùcān  
eating out



# 咖啡馆 kāfēiguǎn • café



菜单  
càidān  
menu

遮阳篷  
zhēyángpéng  
awning

路边咖啡座 lùbiān kāfēizuò | pavement café



遮阳伞  
zhēyángsǎn  
umbrella

露天咖啡座  
lùtiān kāfēizuò  
terrace café



侍者  
shìzhě  
waiter

咖啡机  
kāfēijī  
coffee machine

桌子  
zhuōzi  
table

快餐店 kuàicāndiàn | snack bar

# 咖啡 kāfēi • coffee

牛奶咖啡  
niú'nǎi kāfēi  
white coffee

黑咖啡  
hēikāfēi  
black coffee

可可粉  
kěkěfěn  
cocoa powder

泡沫  
pàomò  
froth



过滤式咖啡  
guòlǜshì kāfēi  
filter coffee



意式浓缩咖啡  
yìshìnóngsuō kāfēi  
espresso



卡布奇诺咖啡  
kǎbùqínò kāfēi  
cappuccino



冰咖啡  
bīngkāfēi  
iced coffee

茶 chá • tea

草药茶  
cǎoyàochá  
herbal tea



奶茶  
nǎichá  
tea with milk

红茶  
hóngchá  
black tea



菊花茶  
júhuāchá  
camomile tea



柠檬茶  
níngméngchá  
tea with lemon



绿茶  
lǜchá  
green tea



薄荷茶  
bòhechá  
mint tea



冰茶  
bīngchá  
iced tea

果汁和奶昔 guǒzhī hé nǎixī • juices and milkshakes



橘子汁  
júzǐzhī  
orange juice



苹果汁  
píngguǒzhī  
apple juice



菠萝汁  
bōluózhī  
pineapple juice



番茄汁  
fānqiézhī  
tomato juice

巧克力奶昔  
qiǎokèlì nǎixī  
chocolate milkshake

草莓奶昔  
cǎoméi nǎixī  
strawberry milkshake

咖啡奶昔  
kāfēi nǎixī  
coffee milkshake



食物 shíwù • food

黑面包  
hēimiànbāo  
brown bread



烤三明治  
kāosānmíngzhì  
toasted sandwich



沙拉  
shālā  
salad



一勺量  
yīsháo liàng  
scoop

冰激凌  
bīngjīlíng  
ice cream



油酥点心  
yóusūdiǎnxīn  
pastry



# 酒吧 jiǔbā • bar



玻璃杯  
bōlibēi  
glasses

量杯  
liángbēi  
optic

收款机  
shōukuǎnjī  
till

酒保  
jiǔbǎo  
bartender

啤酒龙头  
pījiǔ lóngtóu  
beer tap

咖啡机  
kāfēijī  
coffee machine

冰桶  
bīngtǒng  
ice bucket

酒吧椅  
jiǔbāyǐ  
bar stool

烟灰缸  
yānhuīgāng  
ashtray

杯垫  
bēidiàn  
coaster

吧台  
bātái  
bar counter

开瓶器  
kāipíngqì  
bottle opener



拔塞钻 bāsāizhuàn / corkscrew

摇杆  
yáogǎn  
lever

夹钳  
jiáqián  
tongs



鸡尾酒调制器 jīwěijiǔ tiáozhìqì  
cocktail shaker

搅拌棒  
jiǎobànbàng  
stirrer

量杯  
liángbēi  
measure



奎宁杜松子酒  
kuíning dùsōngzǐjiǔ  
gin and tonic

水罐  
shuǐguàn  
pitcher



加水威士忌  
jiāshuǐ wēishìjī  
scotch and water



加可乐朗姆酒  
jiākèlè lǎngmǔjiǔ  
rum and coke

冰块  
bīngkuài  
ice cube



加橙汁伏特加酒  
jiāchéngzhī fú tè jiā jiǔ  
vodka and orange



马提尼酒  
mǎtíni jiǔ  
martini



鸡尾酒  
jīwěijiǔ  
cocktail



葡萄酒  
pútáojiǔ  
wine



啤酒 pǐjiǔ | beer



一小杯  
yì xiǎobēi  
a shot

单份  
dānfèn  
single



量杯  
liángbēi  
measure

双份  
shuāngfèn  
double



不加冰  
bù jiābīng  
without ice

冰和柠檬  
bīng hé níngméng  
ice and lemon



加冰  
jiābīng  
with ice



## 酒吧小吃 jiǔbā xiǎochī • bar snacks



炸薯片 zhàshǔpiàn | crisps

杏仁  
xìngrén  
almonds

腰果  
yāoguǒ  
cashewnuts

花生  
huāshēng  
peanuts



坚果 jiānguǒ | nuts



橄榄 gǎnlǎn | olives



# 餐馆 cānguǎn • restaurant

禁烟区  
jīnyānqū  
non-smoking  
section

餐巾  
cānjīn  
napkin

助厨  
zhùchú  
commis chef



厨房 chúfáng | kitchen

餐具摆放  
cānjù bǎifàng  
table setting

主厨  
zhǔchú  
chef

玻璃杯  
bōlibēi  
glass

托盘  
tuōpán  
tray

侍者 shìzhě | waiter

## 词汇 cíhuì • vocabulary

晚餐菜单  
wǎncān càidān  
evening menu

特色菜  
tèsècài  
specials

价格  
jiàgé  
price

小费  
xiǎofèi  
tip

自助餐  
zìzhùcān  
buffet

客人  
kèrén  
customer

酒单  
jiǔdān  
wine list

按菜单点菜  
àn càidān diǎncài  
à la carte

账单  
zhàngdān  
bill

含服务费  
hán fúwùfèi  
service included

酒吧  
jiǔbā  
bar

盐  
yán  
salt

午餐菜单  
wǔcān càidān  
lunch menu

甜食小车  
tiánshí xiǎochē  
sweet trolley

收据  
shōujù  
receipt

不含服务费  
bùhán fúwùfèi  
service not included

吸烟区  
xīyānqū  
smoking section

胡椒粉  
hújiāofěn  
pepper



菜单  
càidān  
menu



儿童套餐  
értóng tàocān  
child's meal



点菜 diǎncài | order (v)



付账 fùzhàng | pay (v)

菜肴 cài yáo • courses



开胃酒  
kāiwèijiǔ  
apéritif



开胃酒  
kāiwèijiǔ  
starter



汤  
tāng  
soup



主菜  
zhǔcài  
main course



配菜  
pèicài  
side order

餐叉  
cānchā  
fork



餐后甜点 cānhòu tiándiǎn  
dessert

咖啡匙  
kāfēichí  
coffee spoon



咖啡 kāfēi | coffee

要一张两人桌。  
yào yīzhāng liǎngrenzhuō.  
A table for two please.

能让我看看菜单/酒单吗？  
néng ràng wǒ kànkān càidān/jiǔdān ma?  
Can I see the menu/winelist please?

有固定价格菜单吗？  
yǒu gùdìng jiàgé càidān ma?  
Is there a fixed price menu?

有素食吗？  
yǒu sùshí ma?  
Do you have any vegetarian dishes?

请给我账单/收据。  
qǐng gěi wǒ zhàngdān/shōujù.  
Could I have the bill/a receipt please?

我们能分开结账吗？  
wǒmen néng fēnkāi jiézhàng ma?  
Can we pay separately?

请问卫生间在哪儿？  
qǐngwèn wèishēngjiān zài nǎ'èr?  
Where are the toilets, please?



# 快餐 kuàicān • fast food



汉堡包  
hànbǎobāo  
burger

吸管  
xīguǎn  
straw

软饮料  
ruǎn yǐnliào  
soft drink

薯条  
shǔtiáo  
french fries

餐巾纸  
cānjīnzhǐ  
paper napkin

托盘  
tuōpán  
tray

汉堡套餐 hànbǎotàocān | burger meal



比萨饼  
bǐsàbǐng  
pizza

价目表  
jiàmùbiǎo  
price list

送餐 sòngcān | home delivery



罐装饮料  
guǎnzuāng yǐnliào  
canned drink

食品摊 shípǐntān | street stall

## 词汇 cíhuì • vocabulary

比萨饼店  
bǐsàbǐngdiàn  
pizza parlour

快餐店  
kuàicāndiàn  
burger bar

菜单  
càidān  
menu

店内用餐  
diànnèi yòngcān  
eat-in

外带  
wàidài  
take-away

重新加热  
chóngxīn jiārè  
re-heat (v)

番茄酱  
fānqiéjiàng  
tomato sauce

我带走吃。  
wǒ dàizǒu chī.  
Can I have that to go please?

你们提供送餐服务吗？  
nǐmen tígòng sòngcānfúwù ma?  
Do you deliver?



汉堡包  
hànbǎobāo  
hamburger



鸡肉汉堡  
jīròu hànbǎo  
chicken burger

小圆面包  
xiǎoyuán  
miànbāo  
bun



蔬菜汉堡  
shūcài hànbǎo  
veggie burger

芥末  
jièmò  
mustard

香肠  
xiāngcháng  
sausage

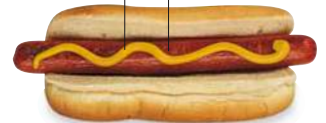

热狗 règǒu | hot dog



三明治  
sānmíngzhì  
sandwich



总汇三明治  
zǒnghuì sānmíngzhì  
club sandwich



单片三明治  
dānpian sānmíngzhì  
open sandwich

馅  
xiàn  
filling



菜卷  
càijiǔǎn  
wrap



烤肉串  
kǎoròuchuàn  
kebab

酱  
jiàng  
sauce



鸡块  
jīkuài  
chicken nuggets

开胃的  
kāiwèide  
savoury



薄饼卷 báobǐngjuǎn | crêpes

甜味的  
tiánwèide  
sweet



装饰配料  
zhuāngshìpèiliào  
topping



鱼和薯条  
yú hé shǔtiáo  
fish and chips



肋排  
lèipái  
ribs



炸鸡  
zháji  
fried chicken



比萨饼  
bǐsàbǐng  
pizza



# 早餐 zǎocān • breakfast



牛奶 niú'nǎi milk

谷类食品 gǔlèishípǐn cereal

果酱 guǒjiàng jam

干果 gānguǒ dried fruit

火腿 huǒtuǐ ham

奶酪 nǎilǎo cheese

薄脆饼干 báocuībǐnggān crispbread

自助早餐 zìzhùzǎocān breakfast buffet

橘子酱 júzǐjiàng marmalade

肉酱 ròujiàng pâté

黄油 huángyóu butter

果汁 guǒzhī fruit juice

咖啡 kāfēi coffee



早餐桌 zǎocānzhuō | breakfast table

热巧克力 rèqiǎokèlì

羊角面包 yángjiǎo miànbāo croissant



茶 chá tea

饮料 yǐnliào | drinks



奶油糕点  
nǎiyóugāodiǎn  
brioche



面包  
miànbāo  
bread

烤面包  
kǎomiànbāo  
toast

煎蛋  
jiāndàn  
fried egg

番茄  
fānqiē  
tomato

猪血香肠  
zhūxuè xiāngcháng  
black pudding

香肠  
xiāngcháng  
sausage

熏肉  
xūnròu  
bacon

英式早餐  
yīngshì zǎocān  
English breakfast



熏鲱鱼  
xūnfēiyú  
kippers



法式吐司  
fǎshìtǔsī  
french toast

蛋黄  
dànhuáng  
yolk



煮鸡蛋  
zhǔjīdàn  
boiled egg

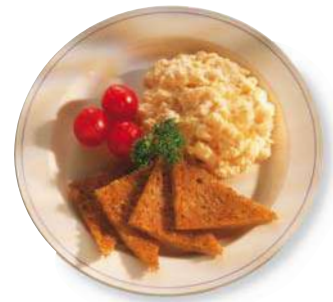

炒鸡蛋  
chǎojiǎndàn  
scrambled eggs

奶油  
nǎiyóu  
cream



薄煎饼  
báojiānbǐng  
pancakes



华夫饼  
huáfūbǐng  
waffles

果味酸奶  
guǒwèisuānnǎi  
fruit yoghurt



麦片粥  
màipiànzhōu  
porridge



鲜果  
xiānguǒ  
fresh fruit



# 正餐 zhèngcān • dinner



汤 tāng | soup



肉汤 ròutāng | broth



炖菜 dùncài | stew



咖喱 gālǐ | curry



烤肉 kǎoròu | roast



馅饼 xiànbǐng | pie



蛋奶酥 dànnǎisū | soufflé



烤肉串 kǎoròuchuàn | kebab



肉丸 ròuwán | meatballs



煎蛋饼 jiāndànbing | omelette



炒菜 chǎocài | stir fry

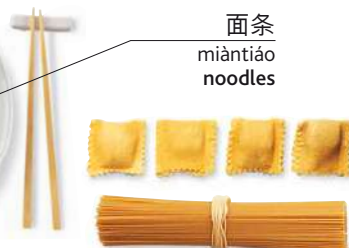

面条  
miàntiáo  
noodles

意大利面食 yìdàlì miànshí  
pasta



米饭 mǐfàn | rice



什锦沙拉 shíjīnshālā  
mixed salad



蔬菜沙拉 shūcǎishālā  
green salad



酸醋调味汁 suāncù  
tiáowèizhī | dressing

烹调手法 pēngtiáo shǒufǎ • techniques



装馅 zhuāngxiàn | stuffed



浇汁 jiāozhī | in sauce



烤制 kǎozhì | grilled



醋渍 cùzì | marinated



水煮 shuǐzhǔ | poached



捣成糊状 dǎochénghúzhuàng | mashed



烘制 hōngzhì | baked



煎制 jiānzhì | pan fried



炒制 chǎozhì | fried



腌渍 yānzì | pickled



熏制 xūnzhì | smoked



油炸 yóuzhā | deep fried



枫糖浸泡 fēngtángjìnpào  
in syrup



调味 tiáowèi | dressed



清蒸 qīngzhēng | steamed



风干 fēnggān | cured









学习 xuéxí  
study



# 学校 xuéxiào • school

老师  
lǎoshī  
teacher

黑板  
hēibǎn  
blackboard



教室 jiàoshì | classroom



男生 nánshēng | schoolboy

学生  
xuéshēng  
pupil

校服  
xiàofú  
school uniform

课桌  
kèzhuō  
desk

书包  
shūbāo  
school bag

粉笔  
fēnbǐ  
chalk



女生  
nǚshēng  
schoolgirl

## 词汇 cíhuì • vocabulary

历史  
lìshǐ  
history

自然科学  
zìránkēxué  
science

物理  
wùlǐ  
physics

语言  
yǔyán  
languages

艺术  
yìshù  
art

化学  
huàxué  
chemistry

文学  
wénxué  
literature

音乐  
yīnyuè  
music

生物学  
shēngwùxué  
biology

地理  
dìlǐ  
geography

数学  
shùxué  
maths

体育  
tǐyù  
physical  
education

## 学习活动 xuéxí huódòng • activities



读 dú | read (v)



写 xiě | write (v)



拼写 pīnxiě | spell (v)



画 huà | draw (v)



幻灯机  
huàndēngjī  
overhead projector



钢笔  
gāngbǐ  
pen



铅笔  
qiānbǐ  
pencil



彩色铅笔  
cǎisèqiānbǐ  
colouring pencil

转笔刀  
zhuǎnbǐdāo  
pencil sharpener



橡皮  
xiàngpí  
rubber



教科书 jiàokeshū | textbook



笔袋 bǐdài | pencil case



尺子 chǐzi | ruler



提问 tíwèn | question (v)



回答 huídá | answer (v)



讨论 tāolùn | discuss (v)



学习 xuéxí | learn (v)

词汇 cíhuì • vocabulary

校长  
xiàozhǎng  
head teacher

答案  
dànw  
answer

评分  
píngfēn  
grade

课  
kè  
lesson

作业  
zuòyè  
homework

年级  
niánjí  
year

问题  
wèntí  
question

考试  
kǎoshì  
examination

字典  
zìdiǎn  
dictionary

记笔记  
jìbǐjì  
take notes (v)

作文  
zuòwén  
essay

百科全书  
bǎikēquánshū  
encyclopedia



# 数学 shùxué • maths

## 平面图形 píngmiàntúxíng • shapes

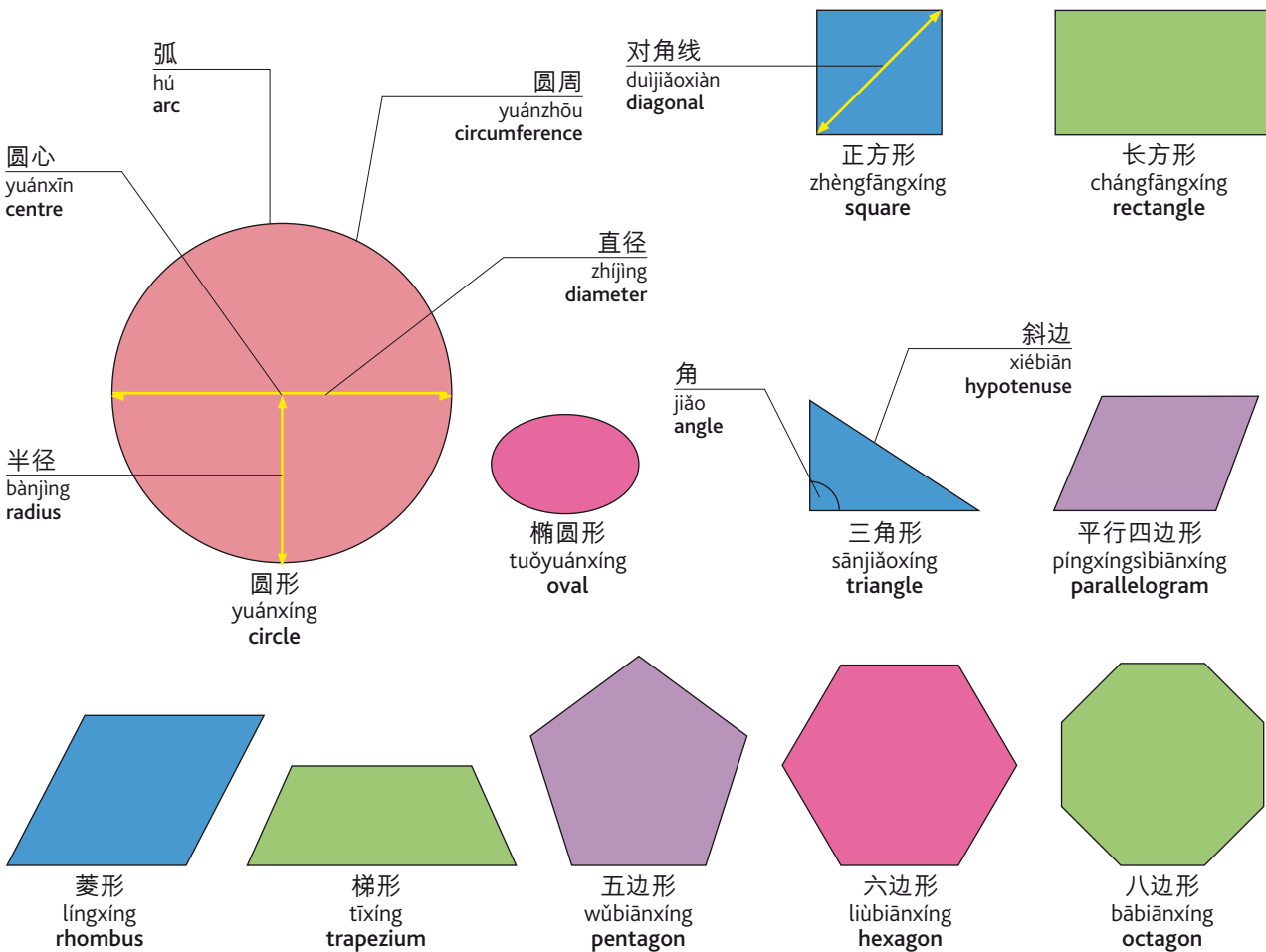

## 立体 lìtǐ • solids

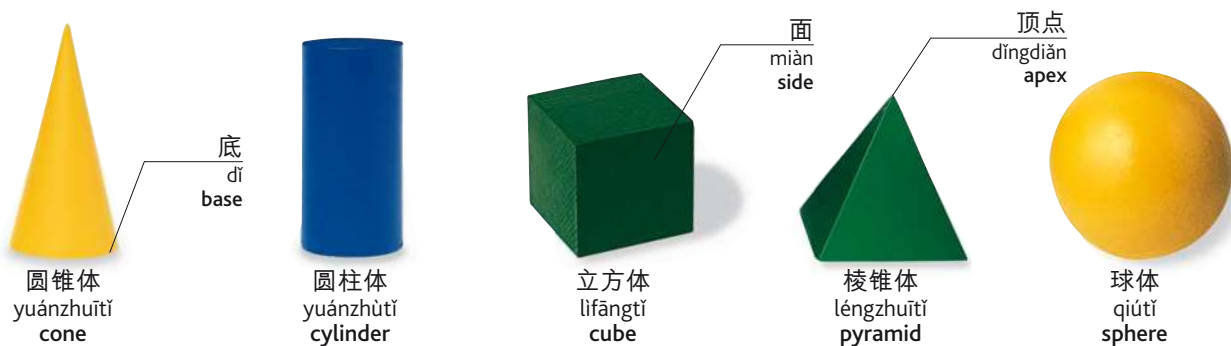

线 xiàn • lines



平直  
píngzhí  
straight

平行  
píngxíng  
parallel

垂直  
chuízhí  
perpendicular

弯曲  
wānqū  
curved

度量 dùliàng • measurements



体积  
tǐjī  
volume

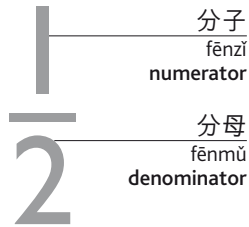

分数  
fēnshù  
fraction

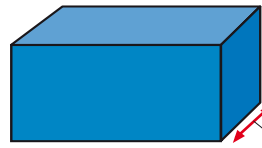

尺寸  
chǐcùn  
dimensions

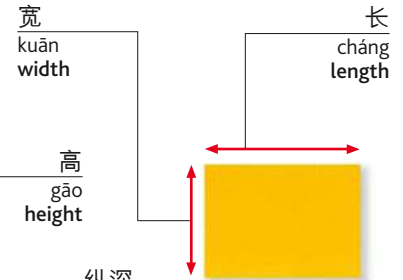

面积  
miànjī  
area

学习用具 xuéxíyòngjù • equipment



三角板  
sānjiǎobǎn  
set square



量角器  
liángjiǎoqì  
protractor



直尺  
zhíchǐ  
ruler



圆规  
yuánguī  
compass



计算器  
jìsuànjī  
calculator

词汇 cíhuì • vocabulary

几何  
jǐhé  
geometry

正  
zhèng  
plus

倍  
bèi  
times

等于  
děngyú  
equals

加  
jiā  
add (v)

乘  
chéng  
multiply (v)

等式  
děngshì  
equation

算术  
suànshù  
arithmetic

负  
fù  
minus

除以  
chúyǐ  
divided by

计数  
jìshù  
count (v)

减  
jiǎn  
subtract (v)

除  
chú  
divide (v)

百分比  
bǎifēnbǐ  
percentage



# 科学 kēxué • science



实验室  
shíyànshì  
laboratory



天平  
tiānpíng  
scales

砝码  
fǎmǎ  
weight

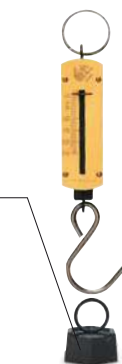

弹簧秤  
tánhuángchèng  
spring balance

坩埚  
gānguō  
crucible

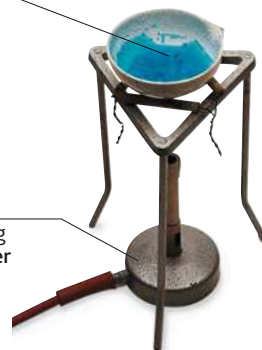

本生灯  
běnshēngdēng  
bunsen burner

三脚架  
sānjiǎojià  
tripod



玻璃瓶  
bōlipíng  
glass bottle

漏斗  
lòudǒu  
funnel

烧瓶  
shāopíng  
flask

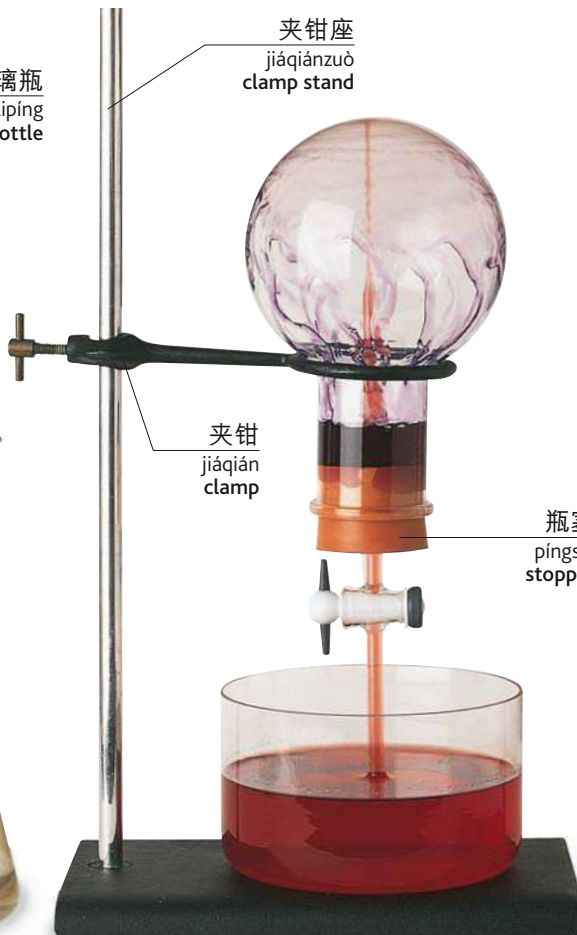

夹钳座  
jiáqiǎnzuo  
clamp stand

夹钳  
jiáqiǎn  
clamp

瓶塞  
píngsāi  
stopper

实验 shíyàn | experiment

试管  
shìguǎn  
test tube



试管架  
shìguǎnjià  
rack



计时器  
jìshíqì  
timer



培养皿  
péiyǎngmǐn  
petri dish



温度计  
wēndùjì  
thermometer



注射器  
zhùshèqì  
syringe



镊子  
nièzi  
tweezers



解剖刀  
jiěpōudāo  
scalpel



滴管 dīguǎn | dropper



医用钳 yīyòngqián | forceps



钳子 qiánzi | tongs



刮刀 guādāo | spatula

研杵  
yánchǔ  
pestle



研钵  
yánbō  
mortar



滤纸  
lǜzhǐ  
filter paper



护目镜  
hùmùjǐng  
safety goggles

目镜  
mùjǐng  
eyepiece

调焦旋钮  
tiáojiāoxuǎnniǔ  
focusing knob



物镜  
wùjǐng  
objective lens

载物台  
zǎiwùtái  
stage

载玻片  
zǎibōpiàn  
slide

反射镜  
fǎnshèjǐng  
mirror

显微镜 xiǎnwēijǐng | microscope



玻璃棒  
bōlibàng  
glass rod



烧杯  
shāobēi  
beaker

吸管  
xīguǎn  
pipette



磁铁  
cítiè  
magnet



鳄鱼夹  
èyújiá  
crocodile clip

负极  
fùjī  
negative electrode



电池 diàncí | battery

正极  
zhèngjí  
positive electrode



# 高等院校 gāoděngyuànxìào • college

招生办  
zhāoshēngbàn  
admissions

学生食堂  
xuéshēngshítáng  
refectory

健康中心  
jiànkāngzhōngxīn  
health centre



校园 xiàoyuán | campus

运动场  
yùndòngchǎng  
sports field

学生宿舍  
xuéshēngsùshè  
hall of  
residence

书目  
shūmù  
catalogue

## 词汇 cíhuì • vocabulary

借书证  
jièshūzhèng  
library card

问询处  
wènxúncù  
enquiries

借出  
jièchū  
loan

阅览室  
yuèlǎnshì  
reading room

借入  
jièrù  
borrow (v)

书  
shū  
book

推荐书目  
tuījiànshūmù  
reading list

预订  
yùdìng  
reserve (v)

书名  
shūmíng  
title

还书日期  
huánshūrìqī  
return date

续借  
xùjiè  
renew (v)

走廊  
zǒuláng  
aisle

借书处  
jièshūchù  
loans desk

书架  
shūjià  
bookshelf

期刊  
qīkān  
periodical

杂志  
zázhì  
journal

图书管理员  
túshūguǎnlǐyuán  
librarian

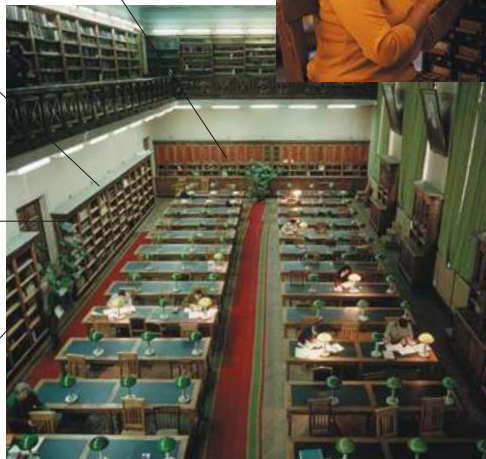

图书馆 túshūguǎn | library

大学生  
dàxuéshēng  
undergraduate

讲师  
jiǎngshī  
lecturer



阶梯教室 jiētījiàoshi | lecture theatre

毕业生  
bìyèshēng  
graduate

学位袍  
xuéwèipáo  
robe



毕业典礼 bìyèdiǎnlǐ | graduation ceremony

## 高等专科学校 gāoděngzhuānkē xuéxiào • schools



美术学院 měishùxuéyuàn  
art college

模特  
mótè  
model



音乐学院 yīnyuèxuéyuàn  
music school



舞蹈学院 wǔdǎoxuéyuàn  
dance academy

### 词汇 cíhuì • vocabulary

奖学金  
jiǎngxuéjīn  
scholarship

研究  
yánjiū  
research

(学位) 论文  
(xuéwèi) lùnwén  
dissertation

医学  
yīxué  
medicine

哲学  
zhéxué  
philosophy

文凭  
wénpíng  
diploma

硕士学位  
shuòshìxuéwèi  
masters

系  
xì  
department

动物学  
dòngwùxué  
zoology

文学  
wénxué  
literature

学位  
xuéwèi  
degree

博士学位  
bóshìxuéwèi  
doctorate

法律  
fǎlǚ  
law

物理学  
wùlǐxué  
physics

艺术史  
yìshùshǐ  
history of art

研究生阶段的  
yánjiūshēng  
jiēduānde  
postgraduate

论文  
lùnwén  
thesis

工程学  
gōngchéngxué  
engineering

政治学  
zhèngzhìxué  
politics

经济学  
jīngjìxué  
economics



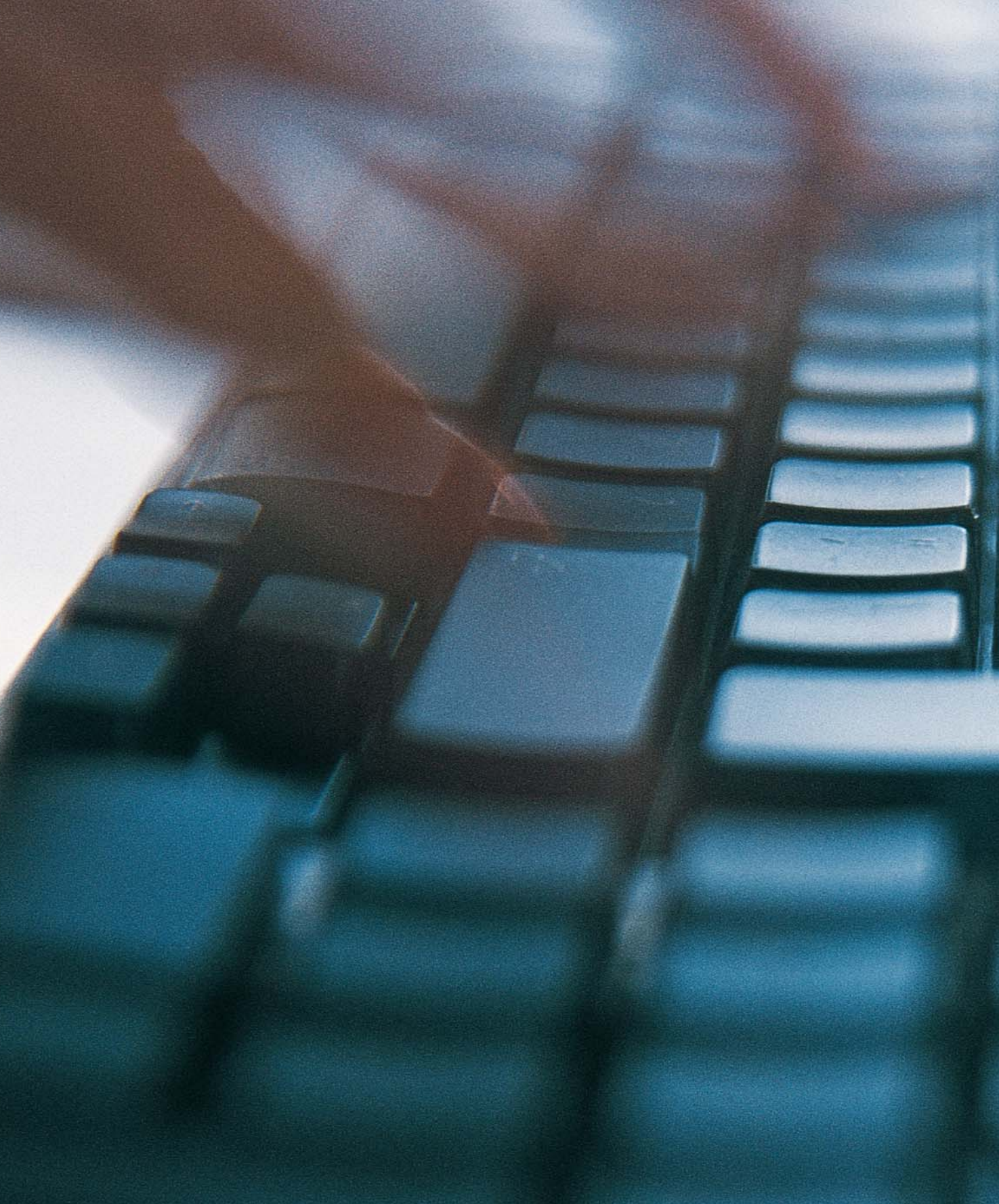





工作 gōngzuò  
work



# 办公室1 bàngōngshìyī • office 1

## 办公室 bàngōngshì • office



## 办公设备 bàngōngshèbèi • office equipment



### 词汇 cíhuì • vocabulary

打印 dǎyìn print (v)

放大 fàngdà enlarge (v)

复印 fùyìn copy (v)

缩小 suōxiǎo reduce (v)

我要复印。  
wǒ yào fùyìn.  
I need to make some copies.

# 办公用品 bàngōngyòngpǐn • office supplies



礼帖  
lǐtiē  
compliments slip



信封  
xìnfēng  
envelope

文件盒  
wénjiàn hé  
box file



分隔页  
fēnggé yè  
divider

盒式文件夹  
héshì wénjiàn jiǎ  
lever arch file

印有笺头的信纸  
yìn yǒu jiǎntóu de xìnzhǐ  
letterhead



带纸夹的笔记本  
dài zhǐjiā de bǐjìbǎn  
clipboard



便笺  
biànjiǎn  
note pad



标签  
biāoqiān  
tab

悬挂式文件夹  
xuànguàshì wénjiàn jiǎ  
hanging file



格式文件夹  
géshì wénjiàn jiǎ  
concertina file



备忘录  
bèiwànglù  
personal organizer



订书钉  
dìngshūding  
staples

订书机  
dìngshūjī  
stapler

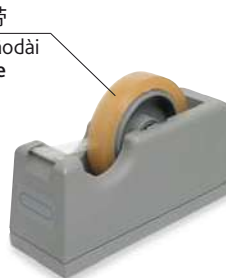

透明胶带  
tòumíngjiāodài  
sticky tape

胶带架  
jiāodàijià  
tape dispenser



打孔器  
dǎkǒngqì  
hole punch



印台  
yìntái  
ink pad

橡皮图章  
xiàngpítúzhāng  
rubber stamp



皮筋  
píjīn  
rubber band



强力纸夹  
qiánglìzhǐjiā  
bulldog clip



曲别针  
qūbiézhēn  
paper clip

图钉  
túding  
drawing pin



公告栏 gōnggàolán | notice board



# 办公室2 bàngōngshì'èr • office 2



会议 huìyì | meeting

## 词汇 cíhuì • vocabulary

会议室  
huìyìshì  
meeting room

参加  
cānjiā  
attend (v)

议程  
yìchéng  
agenda

主持  
zhǔchí  
chair (v)

什么时候开会？  
shénme shíhòu kāihuì?  
What time is the meeting?

您几点上下班？  
nín jǐdiǎn shàngxiàbān?  
What are your office hours?



介绍 jièshào | presentation

# 商务 shāngwù • business

笔记本电脑  
bǐjìběn diànnǎo  
laptop

笔记  
bǐjì  
notes

商人  
shāngrén  
businessman

女商人  
nǚshāngrén  
businesswoman



工作午餐 gōngzuòwǔcān | business lunch



商务旅行 shāngwùlǚxíng | business trip



客户 kèhù | diary

客户  
kèhù  
client  
约会  
yuēhuì  
appointment

掌上电脑  
zhǎngshàng diànnǎo  
palmtop



商业交易 shāngyèjiāoyì | business deal

总经理  
zǒngjīnglǐ  
managing  
director

## 词汇 cíhuì • vocabulary

公司  
gōngsī  
company

员工  
yuángōng  
staff

会计部  
kuàijìbù  
accounts department

法律事务部  
fǎlǚshìwùbù  
legal department

总部，总公司  
zǒngbù, zǒnggōngsī  
head office

薪水  
xīnshuǐ  
salary

市场部  
shìchǎngbù  
marketing department

客户服务部  
kèhùfúwùbù  
customer service department

分部，分公司  
fēnbù, fēngōngsī  
branch

工资单  
gōngzīdān  
payroll

销售部  
xiāoshòubù  
sales department

人力资源部  
rénlìzīyuánbù  
personnel department



# 计算机 jìsuànjī • computer

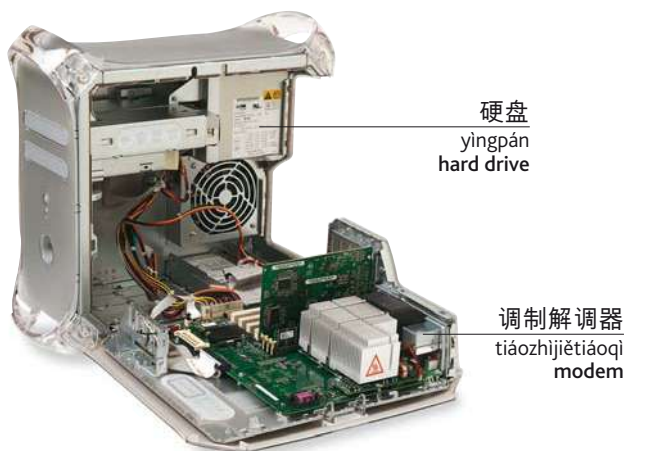

词汇 cíhuì • vocabulary		
存储器 cúnchǔqì memory	软件 ruǎnjiàn software	服务器 fúwùqì server
随机存储器 suíjī cúnchǔqì RAM	应用程序 yīngyòng chéngxù application	端口 duānkǒu port
字节 zìjié bytes	程序 chéngxù program	处理器 chǔlǐqì processor
系统 xìtǒng system	网络 wǎngluò network	电源线 diànyuánxiàn power cable

## 桌面 zhuōmiàn • desktop

菜单栏  
càidānlán  
menubar

工具栏  
gōngjùlán  
toolbar

桌面背景  
zhuōmiàn bèijǐng  
wallpaper

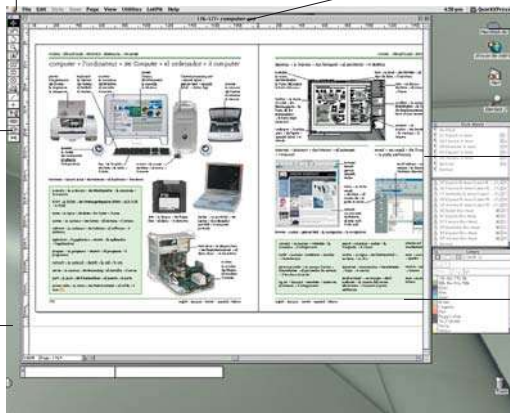

字体  
zìtǐ  
font

图标  
túbiāo  
icon

滚动条  
gǔndòngtiáo  
scrollbar

视窗  
shìchuāng  
window



## 互联网 hùliánwǎng • internet



浏览 liúlǎn | browse (v)

浏览器  
liúlǎnqǐ  
browser

收件箱  
shōujiànxiāng  
inbox

网站  
wǎngzhàn  
website

## 电子邮件 diànzǐyóujiàn • email

电子邮件地址  
diànzǐyóujiàn dìzhǐ  
email address

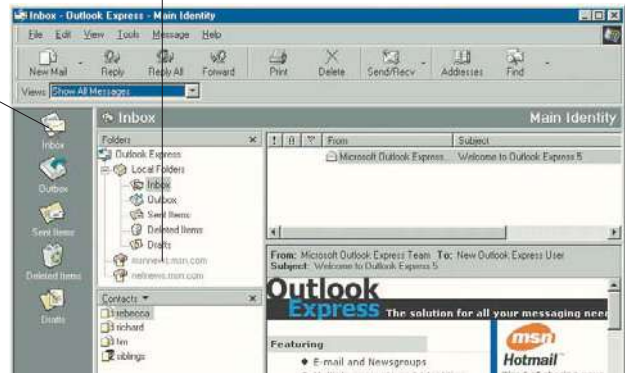

## 词汇 cíhuì • vocabulary

连接  
liánjiē  
connect (v)

服务商  
fúwùshāng  
service provider

登录  
dēnglù  
log on (v)

下载  
xiàzài  
download (v)

发送  
fāsòng  
send (v)

保存  
bǎocún  
save (v)

安装  
ānzhuāng  
instal (v)

电子邮件账户  
diànzǐyóujiàn zhànghù  
email account

在线  
zàixiàn  
on-line

附件  
fùjiàn  
attachment

接收  
jiēshōu  
receive (v)

搜索  
sōusuǒ  
search (v)



# 媒体 méitǐ • media

## 电视演播室 diànshì yǎnbōshì • television studio

节目主持人  
jiémùzhǔchíren  
presenter

照明  
zhàomíng  
light

布景  
bùjǐng  
set



摄像机  
shèxiàngjī  
camera

摄像机升降器  
shèxiàngjī shēngjiàngqì  
camera crane

摄像师  
shèxiàngshī  
cameraman

### 词汇 cíhuì • vocabulary

频道  
píndào  
channel

新闻  
xīnwén  
news

新闻媒体  
xīnwénméitǐ  
press

肥皂剧  
féizàojù  
soap

动画片  
dònghuàpiān  
cartoon

直播  
zhíbō  
live

节目编排  
jiémùbiānpái  
programming

纪录片  
jìlùpījiànpiān  
documentary

电视连续剧  
diànshì liánxùjù  
television  
series

游戏节目  
yóuxìjiémù  
game show

录播  
lùbō  
prerecorded

播放  
bōfàng  
broadcast (v)



采访记者 cǎifǎngjìzhě  
interviewer



记者 jìzhě | reporter



自动提示机 zìdòngtíshìjī  
autocue



新闻播音员 xīnwénbōyīnyuán  
newsreader



演员 yǎnyuán | actors



录音吊杆 lùyīndiàogǎn  
sound boom

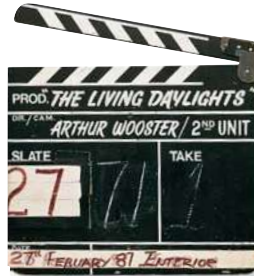

场记板 chǎngjìbǎn  
clapper board



电影布景 diànyǐngbùjǐng  
film set

## 无线电广播 wúxiàndiànguǎngbō • radio

混音台  
húnyīntái  
mixing desk

话筒  
huàtǒng  
microphone

录音师  
lùyīnshī  
sound technician



录音室 lùyīnshì | recording studio

## 词汇 cíhuì • vocabulary

广播电台  
guǎngbōdiàntái  
radio station

中波  
zhōngbō  
medium wave

广播  
guǎngbō  
broadcast

频率  
pínlǜ  
frequency

波长  
bōcháng  
wavelength

音量  
yīnliàng  
volume

长波  
chángbō  
long wave

调音  
tiáoyīn  
tune (v)

短波  
duǎnbō  
short wave

流行音乐节目主持人  
liúxíngyīnyuè jiémù  
zhǔchírén  
DJ



# 法律 fǎlǜ • law

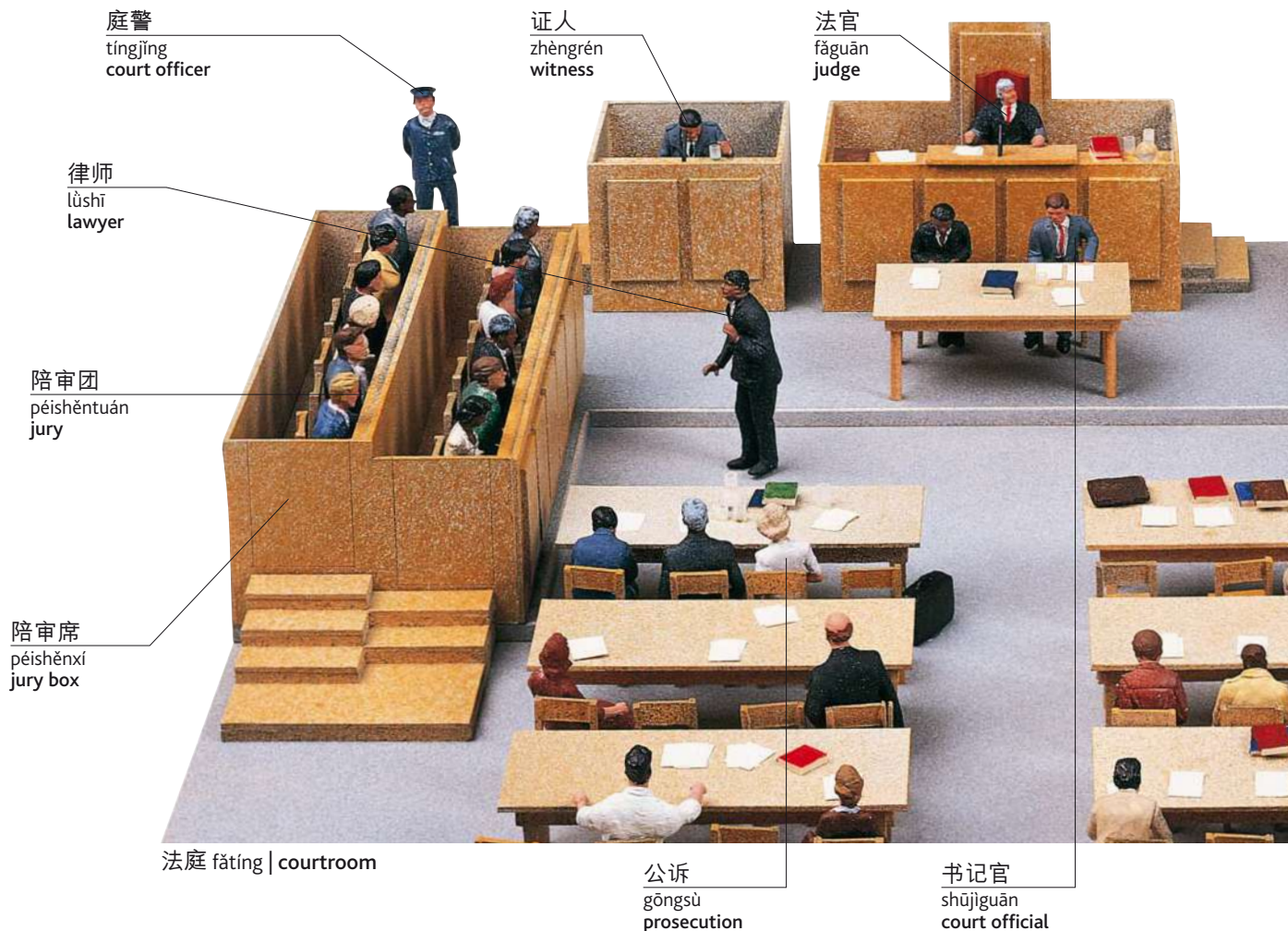

## 词汇 cíhuì • vocabulary

律师事务所  
lǜshīshìwùsuǒ  
lawyer's office

传讯  
chuánxùn  
summons

传票  
chuánpào  
writ

诉讼案件  
sùsòng ànjiàn  
court case

法律咨询  
fǎlǜzixún  
legal advice

陈辞  
chéncí  
statement

开庭日  
kāitīng rì  
court date

控告  
kònggào  
charge

诉讼委托人  
sùsòngwěituōrén  
client

逮捕令  
dàibǔ lìng  
warrant

抗辩  
kàngbiàn  
plea

被告  
bèigào  
accused



速记员  
sùjìyuán  
stenographer

被告人  
bèigāorén  
defendant

应诉方  
yìngsùfāng  
defence



狱警 yùjǐng | prison guard

嫌疑犯  
xiányífàn  
suspect



拼凑人像 pīncòurénxiàng |  
photofit



单人牢房 dānrénláofáng  
cell



罪犯  
zuìfàn  
criminal

犯罪记录 fànzuìjìlù | criminal  
record



监狱 jiānyù | prison

词汇 cíhuì • vocabulary

证据  
zhèngjù  
evidence

有罪  
yǒuzuì  
guilty

保释金  
bǎoshìjīn  
bail

我要见律师。  
wǒ yào jiàn lǚshī.  
I want to see a lawyer.

判决  
pànjué  
verdict

无罪释放  
wúzuìshìfàng  
acquitted

上诉  
shàngsù  
appeal

法院在哪儿？  
fǎyuàn zài nǎ'èr?  
Where is the courthouse?

无罪  
wúzuì  
innocent

判刑  
pàn xíng  
sentence

假释  
jiǎshì  
parole

我可以保释吗？  
wǒ kěyǐ bǎoshì ma?  
Can I post bail?



# 农场1 nóngchǎngyī • farm 1



农民  
nóngmín  
farmer

菜地  
càidì  
vegetable plot

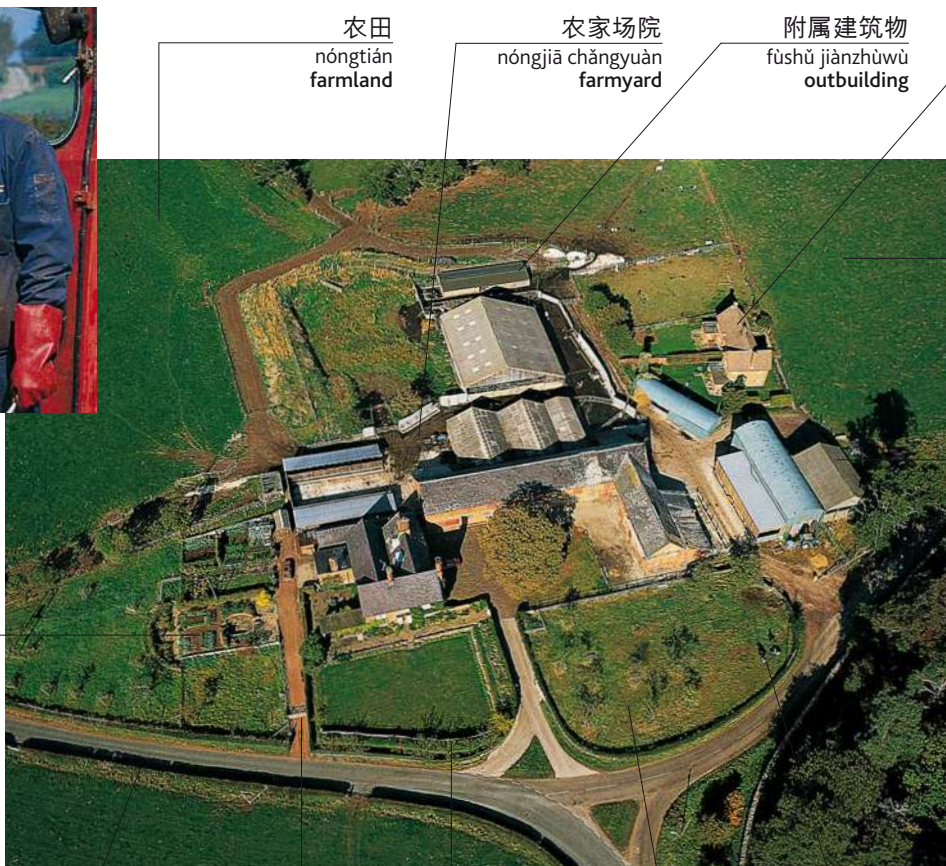

农田  
nóngtián  
farmland

农家场院  
nóngjiā chǎngyuàn  
farmyard

附属建筑物  
fùshǔ jiànzhùwù  
outbuilding

农舍  
nóngshè  
farmhouse

田地  
tiándì  
field

谷仓  
gǔcāng  
barn

树篱  
shùlí  
hedge

大门  
dàmén  
gate

围栏  
wéilán  
fence

牧场  
mùchǎng  
pasture

家畜  
jiāchù  
livestock



拖拉机 tuōlājī | tractor

中耕机  
zhōnggēngjī  
cultivator



联合收割机 liánhéshōugējī | combine harvester

## 农场类型 nóngchǎng lèixíng • types of farm

庄稼

zhuāngjia  
crop

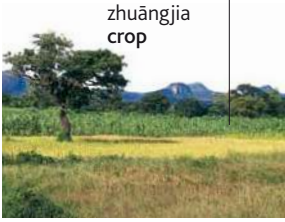

种植园  
zhòngzhíyuán  
arable farm



乳牛场  
rǔniúchǎng  
dairy farm



牧羊场  
mùyángchǎng  
sheep farm

羊群  
yángqún  
flock



养鸡场 yǎngjīchǎng  
poultry farm

葡萄树

pútáoshù  
vine



葡萄园  
pútáoyuán  
vineyard



养猪场  
yǎngzhūchǎng  
pig farm



养鱼场  
yǎngyúchǎng  
fish farm



果园  
guǒyuán  
fruit farm

## 农活 nóng huó • actions

犁

lí  
furrow



犁地  
lídì  
plough (v)



播种  
bōzhǒng  
sow (v)



挤奶  
jǐ'nǎi  
milk (v)

饲养  
sìyǎng  
feed (v)



灌溉 guàngài | water (v)



收获 shōuhuò | harvest (v)

### 词汇 cíhuì • vocabulary

除草剂  
chúcǎoji  
herbicide

牧群  
mùqún  
herd

饲料槽  
sìliàocáo  
trough

杀虫剂  
shāchóngji  
pesticide

地窖  
dìjiào  
silo

种植  
zhòngzhí  
plant (v)



# 农场2 nóngchǎng'èr • farm 2

## 农作物 nóngzuòwù • crops



小麦  
xiǎomài  
wheat



玉米  
yùmǐ  
corn



大麦  
dàmài  
barley



油菜籽  
yóucàizi  
rapeseed



向日葵  
xiàngrikui  
sunflower



捆包  
kǔnbāo  
bale

干草  
gāncǎo  
hay



紫花苜蓿  
zǐhuāmùxū  
alfalfa



烟草  
yāncǎo  
tobacco



水稻  
shuǐdào  
rice



茶  
chá  
tea



咖啡  
kāfēi  
coffee



稻草人  
dàocǎorén  
scarecrow



亚麻  
yàmá  
flax



甘蔗  
gānzhe  
sugarcane



棉花  
miánhuā  
cotton

家畜 jiāchù • livestock

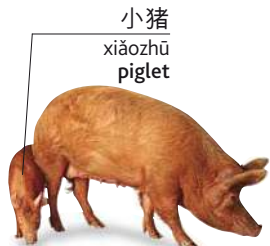

小猪  
xiǎozhū  
piglet

猪  
zhū  
pig

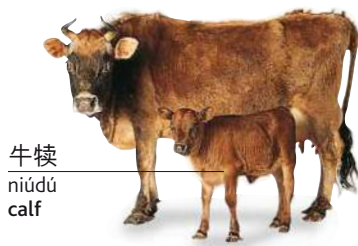

牛犊  
niú dú  
calf

母牛  
mǔniú  
cow



公牛  
gōngniú  
bull



绵羊  
miányáng  
sheep



羊羔  
yánggāo  
lamb



小山羊  
xiǎoshānyáng  
kid

山羊  
shānyáng  
goat



马驹  
mǎjū  
foal

马  
mǎ  
horse



驴  
lǘ  
donkey

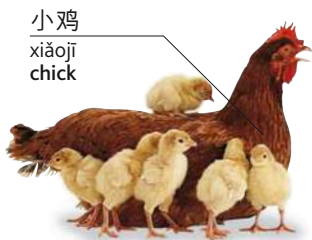

小鸡  
xiǎojī  
chick

鸡  
jī  
chicken



公鸡  
gōngjī  
cockerel



火鸡  
huǒjī  
turkey

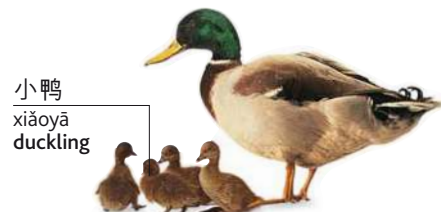

小鸭  
xiǎoyā  
duckling

鸭  
yā  
duck



马厩  
mǎjiù  
stable



家畜圈  
jiāchùquān  
pen



鸡舍  
jīshè  
chicken coop



猪圈  
zhūjuàn  
pigsty



# 建筑 jiànzhù • construction



脚手架  
jiǎoshǒujià  
scaffolding

梯子  
tīzi  
ladder

窗户  
chuānghù  
window

椽子  
chuánzi  
rafter

承砖坯板  
chéngzhuānpībǎn  
pallet

叉车  
chāchē  
fork-lift truck

建筑工地  
jiànzhùgōngdì  
building site

过梁  
guòliáng  
lintel

墙  
qiáng  
wall

大梁  
dàliáng  
girder

安全帽  
ānquánmào  
hard hat

工具腰带  
gōngjùyāodài  
toolbelt

梁  
liáng  
beam

水泥  
shuǐní  
cement



建造  
jiànào  
build (v)



建筑工人  
jiànzhùgōngrén  
builder



水泥搅拌机  
shuǐní jiǎobànqì  
cement mixer

## 建筑材料 jiànzhù cáiliào • materials



砖  
zhuān  
brick



木材  
mùcái  
timber



瓦片  
wǎpiàn  
roof tile



混凝土块  
hùnníngtǔkuài  
concrete block

## 工具 gōngjù • tools

灰浆  
huījiāng  
mortar



抹刀  
mǒdāo  
trowel



水准仪  
shuǐzhǔnyí  
spirit level



大锤  
dàchuí  
sledgehammer



柄  
bǐng  
handle  
丁字镐  
dīngzìgāo  
pickaxe



铁锹  
tiěqiāo  
shovel

## (工程)机械 (gōngchéng) jīxiè • machinery



压路机  
yālùjī  
roller



翻斗卡车  
fāndǒukǎchē  
dumper truck



吊钩  
diàogōu  
hook

起重机 qǐzhòngjī | crane

支座  
zhīzuò  
support

## 道路施工 dào lù shī gōng • roadworks

柏油路面  
bǎiyóulùmiàn  
tarmac

锥形隔离墩  
zhuīxínggélídūn  
cone



风钻  
fēngzuàn  
pneumatic drill



重铺路面  
zhòngpū lùmiàn  
resurfacing

挖掘机  
wājuéjī  
mechanical digger



# 职业1 zhíyèyī • occupations 1



木匠  
mùjiàng  
carpenter



电工  
diàngōng  
electrician



水暖工  
shuǐnuǎngōng  
plumber



建筑工人  
jiànzhùgōngrén  
builder



园丁  
yuándīng  
gardener

吸尘器  
xīchénqì  
vacuum  
cleaner



清洁工  
qīngjié gōng  
cleaner



机械师  
jīxièshī  
mechanic



屠户  
túhù  
butcher

剪刀  
jiǎndāo  
scissors



美发师  
měifàshī  
hairdresser



鱼贩  
yúfàn  
fishmonger



蔬菜水果商  
shūcài shuǐguǒshāng  
greengrocer



花商  
huāshāng  
florist



理发师  
lǐfàshī  
barber



珠宝匠  
zhūbǎojiàng  
jeweller



售货员  
shòuhuòyuán  
shop assistant



房地产商  
fángdìchǎnshāng  
estate agent



配镜师  
pèijìngshī  
optician



牙医  
yáyī  
dentist



医生  
yīshēng  
doctor

口罩  
kǒuzhào  
mask



药剂师  
yàojìshī  
pharmacist



护士  
hùshī  
nurse



兽医  
shòuyī  
vet



农民  
nóngmín  
farmer



渔民  
yúmín  
fisherman



机枪  
jīqiāng  
machine-gun



警察  
jǐngchá  
policeman

徽章  
huīzhāng  
identity badge

制服  
zhìfú  
uniform



保安  
bǎoān  
security guard



水手  
shuǐshǒu  
sailor



消防队员  
xiāofángduìyuán  
fireman



# 职业2 zhíyè'èr • occupations 2



律师  
lǚshī  
lawyer



会计师  
kuàijìshī  
accountant



模型  
mó xíng  
model

建筑师 jiànzhùshī | architect



科学家  
kēxuéjiā  
scientist



老师  
lǎoshī  
teacher



图书管理员  
túshūguǎnliyuan  
librarian



接待员  
jiēdài yuán  
receptionist



邮袋  
yóudài  
mailbag

邮递员  
yóudìyuán  
postman



公共汽车司机  
gōnggòngqìchē sījī  
bus driver



卡车司机  
kǎchē sījī  
lorry driver



出租车司机  
chūzūchē sījī  
taxi driver



飞行员  
fēixíngyuán  
pilot



空中小姐  
kōngzhōngxiǎojiě  
air stewardess



旅行代理  
lǚxíngdàilǐ  
travel agent

厨师帽  
chúshīmào  
chef's hat



厨师  
chúshī  
chef



音乐家  
yīnyuèjiā  
musician



芭蕾舞裙  
bālěiwǔqún  
tutu

舞蹈演员  
wǔdǎoyǎnyuán  
dancer



演员  
yǎnyuán  
actor



歌手  
gēshǒu  
singer



女侍者  
nǚshìzhě  
waitress



酒保  
jiǔbǎo  
barman



运动员  
yùndòngyuán  
sportsman



雕塑家  
diāosùjiā  
sculptor



画家  
huàjiā  
painter



摄影师  
shèyǐngshī  
photographer



新闻播音员  
xīnwén bōyīnyuán  
newsreader



笔记  
bǐjì  
notes

新闻记者  
xīnwén jìzhě  
journalist



编辑  
biānjí  
editor



制图员  
zhìtúyuán  
designer



女缝纫师  
nǚféngrènshī  
seamstress



裁缝  
cáiféng  
tailor









交通运输 jiāotōngyùnshū  
transport



# 道路 dào lù • roads

高速公路  
gāosùgōnglù  
motorway

收费站  
shōufèizhàn  
toll booth

路面标志  
lùmiànbiāozhì  
road markings

主路入口  
zhǔlùrùkǒu  
slip road

单行  
dānxíng  
one-way

隔离带  
gélídài  
divider

交汇处  
jiāohuìchù  
junction

交通信号灯  
jiāotōng  
xínghàodēng  
traffic light

载重汽车  
zàizhòngqìchē  
lorry

中央分车道  
zhōngyāng fēnchēdài  
central reservation

高架桥下通道  
gāojià qiáoxià tōngdào  
underpass

内车道  
nèichēdào  
inside lane

中央车道  
zhōngyāngchēdào  
middle lane

外车道  
wàichēdào  
outside lane

出口  
chūkǒu  
exit ramp

交通  
jiāotōng  
traffic

立交桥  
lǐjiāoqiáo  
flyover

硬质路肩  
yìngzhìlùjiān  
hard shoulder





人行横道  
rénxínghéngdào  
pedestrian crossing



求救电话  
qiújiù diànhuà  
emergency phone



残疾人停车处  
cánjírén tíngchēchù  
disabled parking



人行横道  
rénxínghéngdào  
traffic jam

地图  
ditú  
map



停车计时收费器  
tíngchē jìshí shōufèiqì  
parking meter

交通警察  
jiāotōng jǐngchá  
traffic policeman

词汇 cíhuì • vocabulary

道路交叉处的  
环形路  
dàolù  
jiāochāchùde  
huánxínglù  
roundabout

绕行道路  
ràoxíngdàolù  
diversion

道路施工  
dàolùshīgōng  
roadworks

防撞护栏  
fángzhuànghùlán  
crash barrier

(有中央分隔带的)  
复式车道  
(yǒu zhōngyāng  
fēnggédài)  
fùshì chēdào  
dual  
carriageway

停车  
tíngchē  
park (v)

驾驶  
jiàoshǐ  
drive (v)

倒车  
dàoche  
reverse (v)

超车  
chāochē  
overtake (v)

拖走  
tuōzǒu  
tow away (v)

这是去... 的路吗?  
zhèshìqù... de lù ma?  
Is this the road to...?

哪里可以停车?  
nǎlǐ kěyǐ tíngchē?  
Where can I park?

交通标志 jiāotōng biāozhì • road signs



禁行  
jinxíng  
no entry



限速  
xiànsù  
speed limit



危险  
wēixiǎn  
hazard



禁止停车  
jìnzhǐ tíngchē  
no stopping



禁止右转  
jìnzhǐ yòuzhuǎn  
no right turn



# 公共汽车 gōnggòngqìchē • bus



车门 chēmén | door

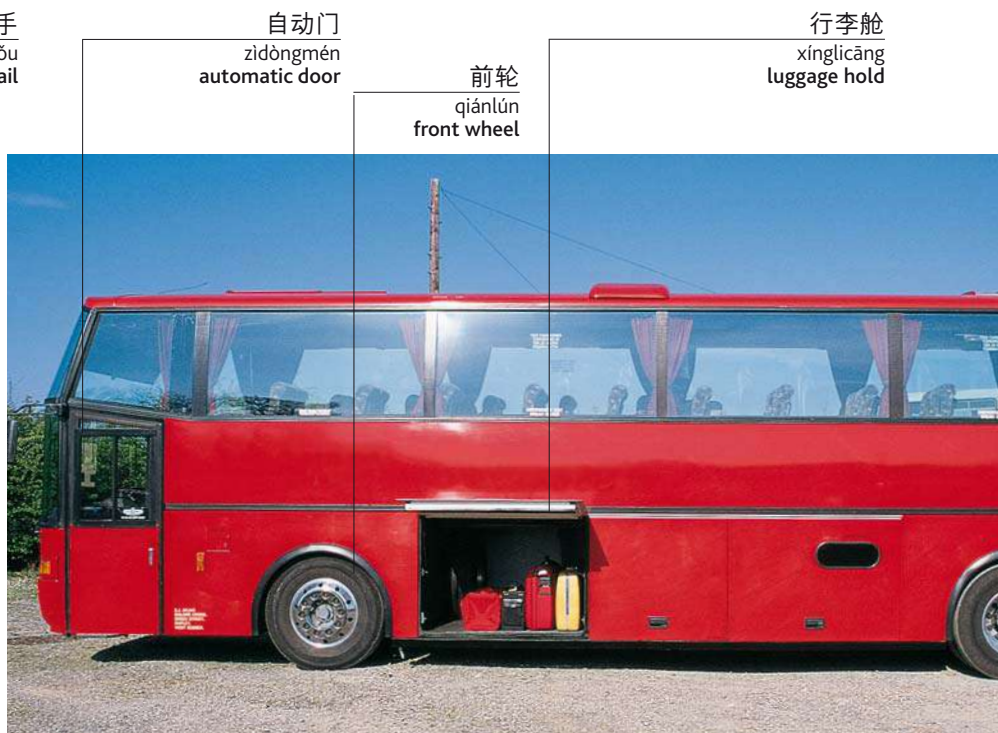

长途汽车 chángtúqìchē | coach

## 公共汽车种类 gōnggòngqìchē zhǒnglèi • types of buses



双层公共汽车  
shuāngcéng gōnggòngqìchē  
double-decker bus

司机  
sījī  
driver





后轮  
hòulún  
rear wheel

窗户  
chuānghù  
window

停车按钮  
tíngchē ànniǔ  
stop button



公共汽车票  
gōnggòngqìchēpiào  
bus ticket



铃  
líng  
bell



公共汽车总站  
gōnggòngqìchē zǒngzhàn  
bus station



公共汽车站  
gōnggòngqìchēzhàn  
bus stop

词汇 cíhuì • vocabulary

车费  
chēfèi  
fare

时刻表  
shíkèbiǎo  
timetable

您在... 停吗？  
nín zài... tíng ma?  
Do you stop at...?

轮椅通道  
lúnqǐ tōngdào  
wheelchair access

公共汽车候车亭  
gōnggòngqìchē hòuchēting  
bus shelter

哪路车去...？  
nǎlù chē qù...?  
Which bus goes to...?



小型公共汽车  
xiǎoxíng gōnggòngqìchē  
minibus



游览车 yóulǎnchē | tourist bus



班车 bānchē | shuttle bus



# 汽车1 qìchēyī • car 1

## 外部 wàibù • exterior

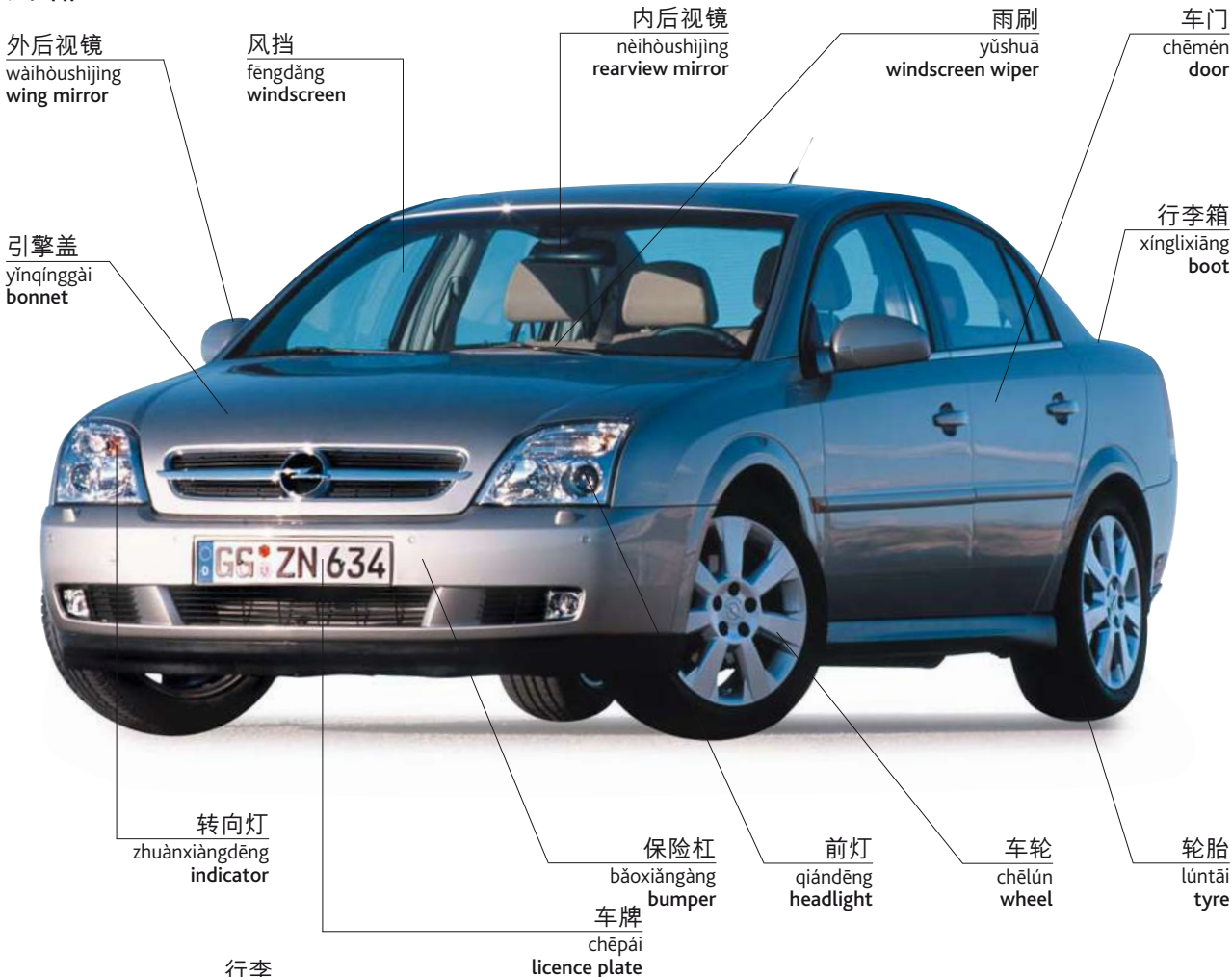

车顶行李架 chēdǐng xínglijīa roofrack



尾部车门 wěibùchēmén tailgate



安全带 ānquándài seat belt



儿童座椅 értóngzuòyǐ child seat

种类 zhǒnglèi • types



微型车  
wēixíngchē  
small car



揭背式轿车  
jiēbèishì jiàochē  
hatchback



家庭轿车，三厢车  
jiātīng jiàochē, sānxiāngchē  
saloon



客货两用车  
kèhuò liǎngyòngchē  
estate



敞篷车  
chǎngpéngchē  
convertible



跑车  
pǎochē  
sports car



六座厢式车  
liùzuò xiāngshìchē  
people carrier



四轮驱动(车)  
sìlúnqūdòng(chē)  
four-wheel drive



老式汽车  
lǎoshìqìchē  
vintage



大型高级轿车  
dàxínggāojí jiàochē  
limousine

加油站 jiāyóuzhàn • petrol station

汽油泵  
qìyóubèng  
petrol pump

价格  
jiàgé  
price

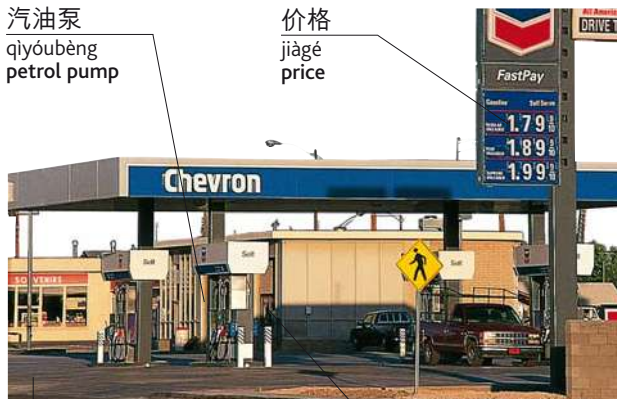

加油处  
jiāyóuchù  
forecourt

轮胎充气机  
lúntāi chōngqìjī  
air supply

词汇 cíhuì • vocabulary

油  
yóu  
oil

含铅  
hánqiān  
leaded

自动洗车站  
zìdòngxǐ chēzhàn  
car wash

汽油  
qìyóu  
petrol

柴油  
cháiyou  
diesel

防冻液  
fángdòngyè  
antifreeze

无铅  
wúqiān  
unleaded

汽车修理站  
qìchē xiūlǐzhàn  
garage

喷水器  
pēnshuǐqì  
screenwash

请加满油。  
qǐng jiāmǎn yóu.  
Fill the tank, please.



# 汽车 2 qìchē'èr • car 2

## 内部 nèibù • interior



### 词汇 cíhuì • vocabulary

双门  
shuāngmén  
two-door

四门  
sìmén  
four-door

自动  
zìdòng  
automatic

刹车  
shāchē  
brake

加速器，油门  
jiāsùqì, yóumén  
accelerator

三门  
sānmén  
three-door

手动  
shǒudòng  
manual

点火  
diǎnhuǒ  
ignition

离合器  
líhéqì  
clutch

空调  
kōngtiáo  
air conditioning

您能告诉我去...的路吗？  
nín néng gàosù wǒ qù...de lù ma?  
Can you tell me the way to...?

停车场在哪里？  
tíngchēchǎng zài nǎlǐ?  
Where is the car park?

这儿可以停车吗？  
zhè'ér kěyǐ tíngchē ma?  
Can I park here?

## 操作装置 cāozuòzhuāngzhì • controls

方向盘  
fāngxiàngpán  
steering  
wheel

喇叭  
lǎba  
horn

仪表盘  
yíbiǎopán  
dashboard

警示灯  
jǐngshìdēng  
hazard lights

卫星导航仪  
wèixīng dǎohángyí  
satellite navigation



左侧驾驶 zuǒcèjiàshǐ | left-hand drive

温度计  
wēndùjì  
temperature gauge

转速表  
zhuànsùbiǎo  
rev counter

车速表  
chē sùbiǎo  
speedometer

油量表  
yóuliàngbiǎo  
fuel gauge

汽车音响  
qìchē  
yīnxiǎng  
car stereo

车灯开关  
chēdēng kāiguān  
lights switch

暖风开关  
nuǎnfēng kāiguān  
heater controls

里程表  
lǐchéngbiǎo  
odometer

变速杆  
biànsùgǎn  
gearstick



右侧驾驶 yòucèjiàshǐ | right-hand drive

安全气囊  
ānquánqīnáng  
air bag



# 汽车 3 qìchēsān • car 3

## 机械构造 jīxiègòuzào • mechanics

挡风玻璃清洗剂容器  
dǎngfēng bōlǐ qīngxǐjī róngqì  
screen wash reservoir

量油计  
liàngyóujì  
dipstick

空气过滤器  
kōngqìguòlǜqì  
air filter

制动液容器  
zhìdòngyè róngqì  
brake fluid reservoir

电池  
diànchí  
battery



车身  
chēshēn  
bodywork

冷却剂容器  
lěngquèjì róngqì  
coolant reservoir

汽缸盖  
qìgānggài  
cylinder head

水管  
shuǐguǎn  
pipe

天窗  
tiānchuāng  
sunroof

散热器  
sǎnrèqì  
radiator

风扇  
fēngshàn  
fan

发动机, 引擎  
fādòngjī, yǐnqīng  
engine

轮毂盖  
lúnǚgài  
hubcap

变速箱  
biànsùxiāng  
gearbox

传动装置  
chuándòng zhuāngzhì  
transmission

驱动轴  
qūdòngzhóu  
driveshaft



# 爆胎 bàotāi • puncture

备用轮胎  
bèiyòng lúntāi  
spare tyre

曲柄  
qūbǐng  
wrench

固定螺母  
gùdìngluómǔ  
wheel nuts

千斤顶  
qiānjīndǐng  
jack

更换轮胎  
gēnghuàn lúntāi  
change a wheel (v)

车顶  
chēdǐng  
roof

汽车悬架  
qìchēxuánjià  
suspension

排气消音器  
páiqìxiāoyīnqì  
silencer

排气管  
páiqìguǎn  
exhaust pipe

## 词汇 cíhuì • vocabulary

车祸  
chēhuò  
car accident

故障  
gùzhàng  
breakdown

保险  
bǎoxiǎn  
insurance

拖车  
tuōchē  
tow truck

机械师  
jīxièshī  
mechanic

胎压  
tāiyā  
tyre pressure

保险盒  
bǎoxiǎnhé  
fuse box

火花塞  
huǒhuāsāi  
spark plug

风扇皮带  
fēngshàn pídài  
fan belt

油箱  
yóuxiāng  
petrol tank

点火定时  
diǎnhuǒdìngshí  
timing

涡轮增压器  
wōlúnzēngyāqì  
turbocharger

配电器  
pèidiànqì  
distributor

底盘  
dǐpán  
chassis

手刹车  
shǒushāchē  
handbrake

交流发电机  
jiāoliúfādiànjī  
alternator

轮轴皮带  
lúnzhóupídài  
cam belt

我的车坏了。  
wǒ de chē huàile.  
I've broken down.

我的车发动不起来。  
wǒ de chē fādòng bù qǐlái.  
My car won't start.

您修车吗？  
nín xiūchē ma  
Do you do repairs?

发动机过热。  
fā dòng jī guò rè  
The engine is overheating



# 摩托车 mótuōchē • motorbike

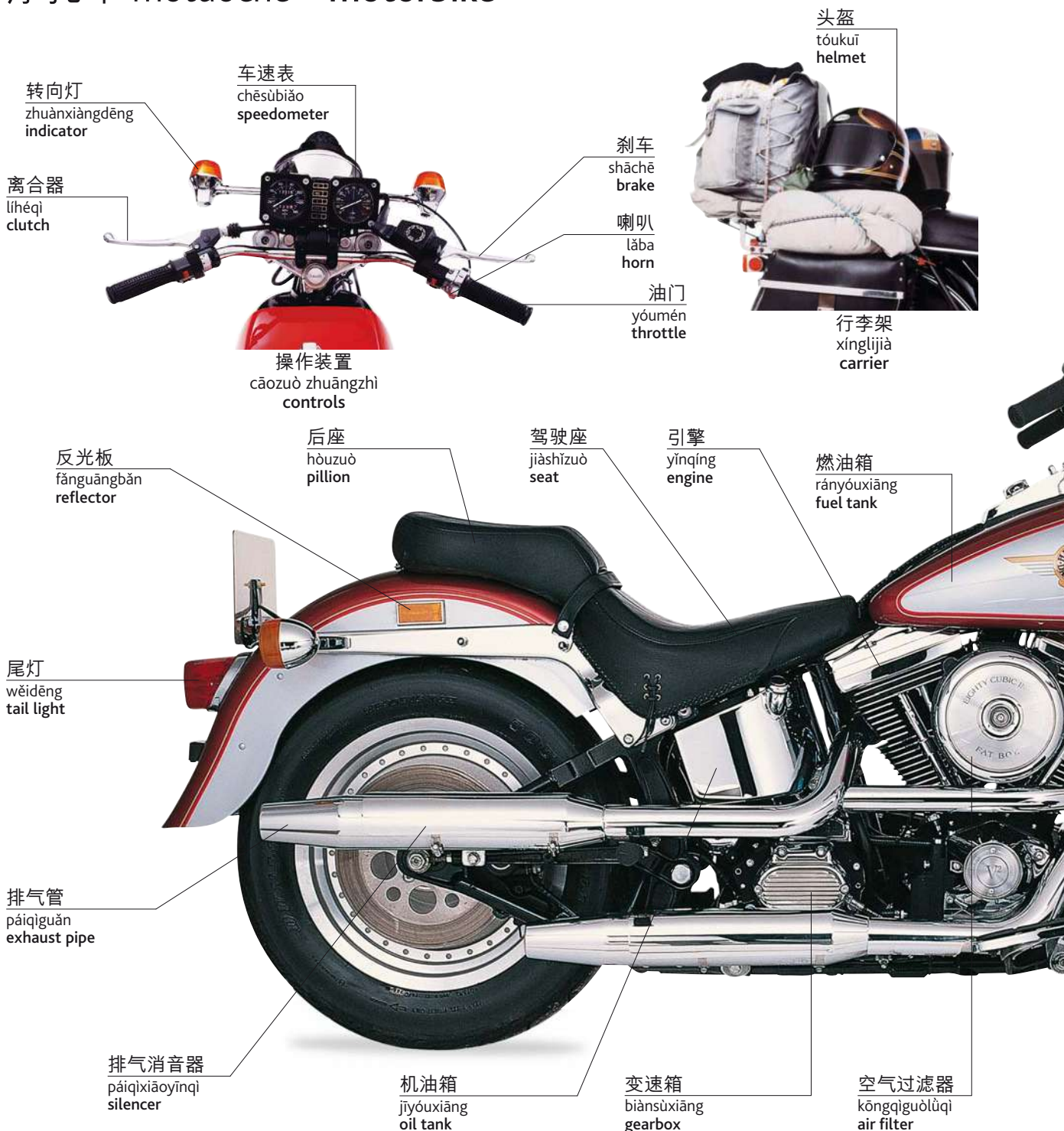

种类 zhǒnglèi • types

头盔面罩  
tóukuīmiànzhào  
visor

反光肩带  
fǎnguāng jiāndài  
reflector strap

皮衣  
piyī  
leathers

护膝  
hùxī  
knee pad



服装 fúzhuāng | clothing

前灯  
qiándēng  
headlight

减震器  
jiǎnzhènqì  
suspension

挡泥板  
dǎngníbǎn  
mudguard

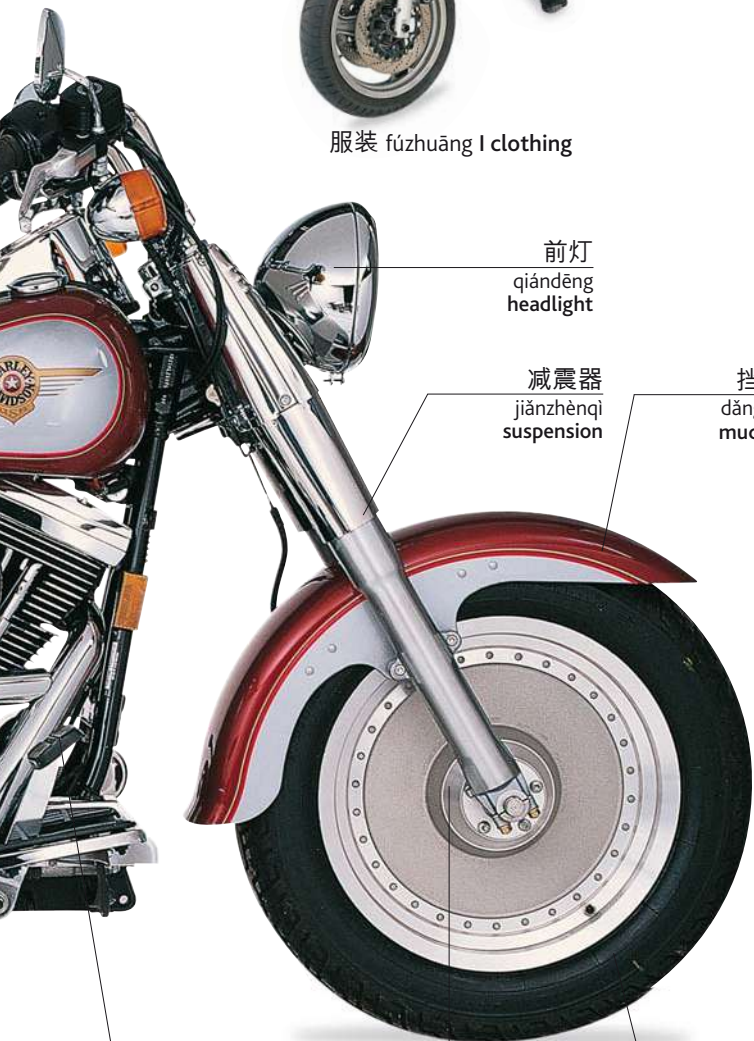

刹车踏板  
shāchētābǎn  
brake pedal

轮轴  
lúnzhóu  
axle

轮胎  
lúntāi  
tyre



赛车 sàichē | racing bike

风挡  
fēngdǎng  
windshield



旅行摩托 lǚxíngmótuō | tourer



越野摩托 yuèyěmótuō | dirt bike

支架  
zhījià  
stand



小轮摩托 xiǎolúnmótuō | scooter



# 自行车 zìxíngchē • bicycle



双座自行车 shuāngzuò zìxíngchē  
tandem



赛车 sàichē  
racing bike



山地车 shāndìchē  
mountain bike



旅行车 lǚxíngchē  
touring bike



公路车 gōnglùchē  
road bike

车座  
chēzuò  
saddle

座杆  
zuògǎn  
seat post

车架  
chējià  
frame

水瓶  
shuǐpíng  
water bottle

刹车  
shāchē  
brake

轮毂  
lúngǔ  
hub

齿轮  
chǐlún  
gears

轮圈  
lúnquān  
rim

轮胎  
lúntāi  
tyre

车链  
chēliàn  
chain

脚蹬  
jiǎodēng  
pedal

链盘  
liànpán  
cog

头盔  
tóukuī  
helmet



自行车道 zìxíngchēdào | cycle lane



词汇 cíhuì • vocabulary

车灯  
chēdēng  
lamp

支架  
zhījià  
kickstand

刹车片  
shāchēpiàn  
brake block

车筐  
chēkuāng  
basket

脚踏套  
tàjiǎotào  
toe clip

刹车  
shāchē  
brake (v)

尾灯  
wěidēng  
rear light

自行车支架  
zìxíngchē zhījià  
bike rack

绳索  
shéngsuǒ  
cable

发电机  
fādiànjī  
dynamo

趾带  
zhǐdài  
toe strap

骑车  
qíchē  
cycle (v)

反光镜  
fǎnguāngjìng  
reflector

稳定轮  
wěndìnglún  
stabilisers

扣链齿  
kòuliànchǐ  
sprocket

爆胎  
bàotāi  
puncture

蹬踏  
dēngtà  
pedal (v)

变速  
biànsù  
change gear (v)



# 列车 lièchē • train

客车厢  
kèchēxiāng  
carriage

站台  
zhàntái  
platform

手推车  
shǒutuīchē  
trolley



站台号  
zhàntáihào  
platform number

旅客  
lǚkè  
commuter

火车站 huǒchēzhàn | train station

# 列车种类 lièchē zhǒnglèi • types of train



蒸汽机车  
zhēngqìjīchē  
steam train



火车头  
huǒchētóu  
engine

驾驶室  
jiàoshǐshì  
driver's cab

铁轨  
tiěguǐ  
rail

柴油机车 cháiyóujīchē | diesel train



电力机车  
diànlìjīchē  
electric train



高速列车  
gāosùlièchē  
high-speed train



单轨列车  
dānguǐlièchē  
monorail



地铁  
dìtiě  
underground train



有轨电车  
yǒuguǐdiànchē  
tram



货车  
huòchē  
freight train



行李架  
xínglijia  
luggage rack

车窗  
chēchuāng  
window

轨道  
guǐdào  
track

门  
mén  
door

座位  
zuòwèi  
seat



检票口 jiǎnpiàokou | ticket barrier

车厢隔间  
chēxiānggéjiān  
compartment

扩音器  
kuòyīnqì  
public address system

列车时刻表  
lièchē shíkèbiǎo  
timetable



车票  
chēpiào  
ticket



餐车 cānchē | dining car



车站大厅 chēzhàn dàtīng | concourse



卧铺车厢  
wòpù chēxiāng  
sleeping compartment

词汇 cíhuì • vocabulary

铁路网  
tiělùwǎng  
rail network

地铁线路图  
dìtiě xiànlùtú  
underground map

售票处  
shòupiàochù  
ticket office

接触轨  
jiēchùguǐ  
live rail

城际列车  
chéngjì lièchē  
inter-city train

晚点  
wǎndiǎn  
delay

检票员  
jiǎnpiàoyuán  
ticket inspector

信号  
xìnhào  
signal

上下班高峰期  
shàngxiàbān gāofēngqī  
rush hour

车费  
chēfèi  
fare

换乘  
huànchéng  
change (v)

紧急刹车闸  
jǐnjǐ shāchēzhá  
emergency lever



# 飞机 fēijī • aircraft

## 班机 bānjī • airliner



## 机舱 jīcāng • cabin





热气球  
rèqìqiú  
hot-air balloon



动力滑翔机  
dònglì huáxiángjī  
microlight



滑翔机  
huáxiángjī  
glider



双翼飞机  
shuāngyì fēijī  
biplane

螺旋桨  
luóxuánjiǎng  
propeller



轻型飞机  
qīngxíng fēijī  
light aircraft



水上飞机  
shuǐshàng fēijī  
sea plane



私人喷气式飞机  
sīrén pēnqìshì fēijī  
private jet



超音速飞机  
chāoyīnsù fēijī  
supersonic jet

旋翼  
xuányì  
rotor blade



直升飞机  
zhíshēng fēijī  
helicopter



轰炸机  
hōngzhàjī  
bomber



导弹  
dǎodàn  
missile  
战斗机  
zhàndòujī  
fighter plane

词汇 cíhuì • vocabulary

飞行员  
fēixíngyuán  
pilot

起飞  
qǐfēi  
take off (v)

着陆  
zhuólù  
land (v)

经济舱  
jīngjìcāng  
economy class

手提行李  
shǒutíxínglǐ  
hand luggage

副驾驶员  
fùjiàshìyuán  
co-pilot

飞行  
fēixíng  
fly (v)

高度  
gāodù  
altitude

商务舱  
shāngwùcāng  
business class

安全带  
ānquándài  
seat belt



# 机场 jīchǎng • airport



停机坪  
tíngjīpíng  
apron

行李拖车  
xínglituōchē  
baggage trailer

候机楼  
hòujīlóu  
terminal

服务车  
fúwùchē  
service vehicle

登机通道  
dēngjītōngdào  
walkway

班机 bānji | airliner

## 词汇 cíhuì • vocabulary

跑道  
pǎodào  
runway

航班号  
hángbānhào  
flight number

行李传送带  
xíngli chuánsòngdài  
carousel

假日  
jiàri  
holiday

国际航线  
guójì hángxiàn  
international flight

入境检查  
rùjìngjiǎnchá  
immigration

安全  
ānquán  
security

办理登机手续  
bànlǐ dēngjī shǒuxù  
check in (v)

国内航线  
guó nèi hángxiàn  
domestic flight

海关  
hǎiguān  
customs

X光行李检查机  
Xguāng xíngli jiǎnchá jī  
X-ray machine

控制塔  
kòngzhìtǎ  
control tower

联运  
liányùn  
connection

超重行李  
chāozhòng xíngli  
excess baggage

假日指南  
jiàri zhǐnán  
holiday brochure

订机票  
dìngjīpiào  
book a flight (v)

手提行李  
shǒutí xíngli  
hand luggage

(大件)行李  
(dàjiàn) xíngli  
luggage

行李推车  
xíngli tuīchē  
trolley



办理登机手续处  
bànlǐ dēngjī shǒuxùchù  
check-in desk



护照 hùzhào | passport

签证  
qiānzhèng  
visa



护照检查处  
hùzhào jiǎnchá chù  
passport control

登机牌  
dēngjīpái  
boarding pass



机票  
jīpiào  
ticket



候机大厅  
hòujīdàtīng  
departure lounge

登机门号  
dēngjīménhào  
gate number

出发  
chūfā  
departures



信息屏  
xìnxíng  
information screen

目的地  
mùdìdì  
destination

抵达  
dīdá  
arrivals



免税商店  
miǎnshuì shāngdiàn  
duty-free shop



领取行李处  
lǐngqǔ xínglichù  
baggage reclaim



出租车站  
chūzūchēzhàn  
taxi rank



租车处  
zūchēchù  
car hire



# 船 chuán • ship

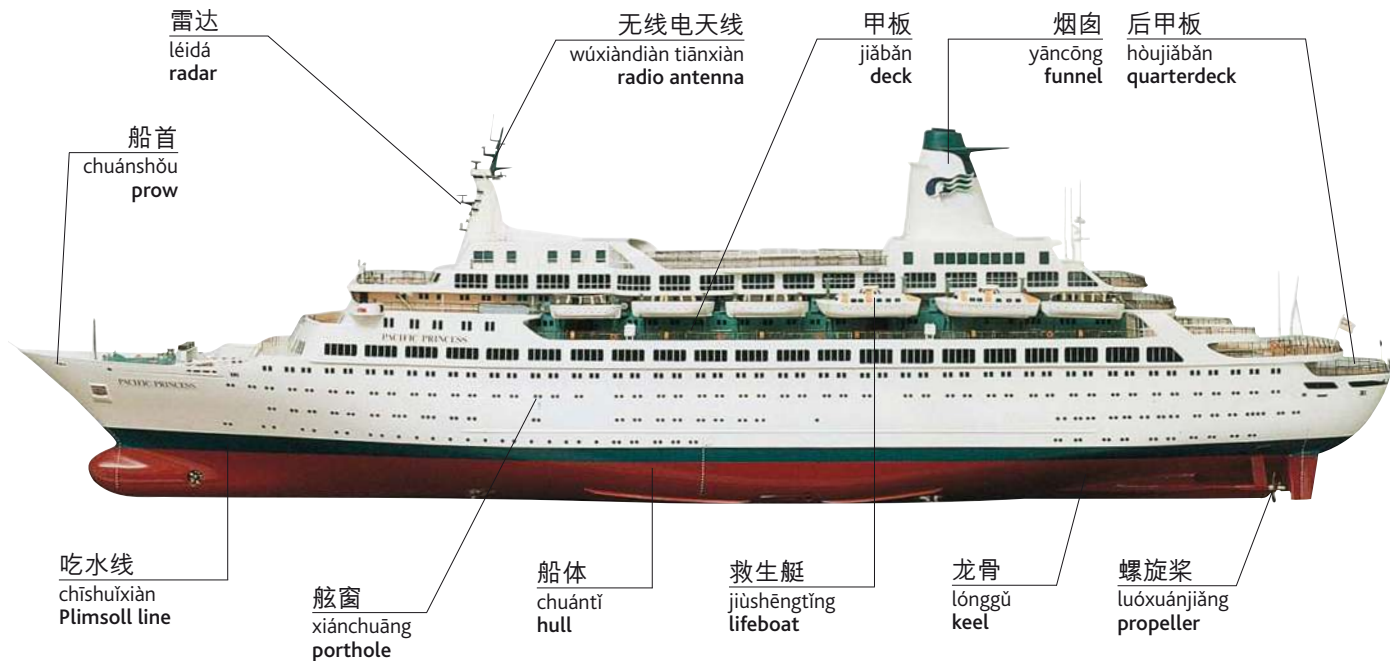

远洋客轮 yuǎnyángkèlún | ocean liner



驾驶台 jiàoshǐtái  
bridge



轮机舱 lúnjīcāng  
engine room



客舱 kècāng  
cabin



船上厨房 chuánshàng chúfáng  
galley

## 词汇 cíhuì • vocabulary

船坞 chuánwù  
dock

港口 gǎngkǒu  
port

舷梯 xiántī  
gangway

锚 máo  
anchor

岸边缆桩 ànbīanlǎnzhuāng  
bollard

卷扬机 juǎnyángjī  
windlass

船长 chuánzhǎng  
captain

快艇 kuàitǐng  
speedboat

划桨船 huájiǎngchuán  
rowing boat

独木舟 dúmùzhōu  
canoe

其他船型 qítāchuánxíng • other ships



渡船  
dùchuán  
ferry

舷外马达  
xiánwàimǎdǎ  
outboard motor



充气式橡皮艇  
chōngqìshì xiàngpítíng  
inflatable dinghy



水翼艇  
shuǐyǐtíng  
hydrofoil



游艇  
yóutíng  
yacht



双体船  
shuāngtǐchuán  
catamaran



拖船  
tuōchuán  
tug boat



气垫船  
qìdiànchuán  
hovercraft



集装箱船  
jízhuāngxiāng chuán  
container ship

帆缆  
fānlǎn  
rigging



帆船  
fānchuán  
sailboat

货舱  
huòcāng  
hold



货船  
huòchuán  
freighter



油轮  
yóulún  
oil tanker



航空母舰  
hángkōng mǔjiàn  
aircraft carrier



战舰  
zhànjiàn  
battleship

指挥塔  
zhǐhuītǎ  
conning tower



潜水艇  
qiánshuǐtíng  
submarine



# 港口 gǎngkǒu • port

仓库  
cāngkù  
warehouse

起重机  
qǐzhòngjī  
crane

叉车  
chāchē  
fork-lift truck

出入港通道  
chūrùgǎng tōngdào  
access road

海关  
hǎiguān  
customs house



船坞  
chuánwù  
dock

集装箱  
jízhuāngxiāng  
container

码头  
mǎtóu  
quay

货物  
huòwù  
cargo



集装箱港口 jí zhuāng xiāng gǎng kǒu | container port

渡船码头  
dùchuán mǎtóu  
ferry terminal

渡船  
dùchuán  
ferry

售票处  
shòupiàochù  
ticket office

乘客  
chéngkè  
passenger



客运码头 kè yùn mǎ tóu | passenger port

渔网  
yúwǎng  
net

渔船  
yúchuán  
fishing boat

缆绳  
lǎnshéng  
mooring



渔港 yúgǎng | fishing port



小船停靠区 xiǎochuántíngkàoqū | marina



港口 gǎngkǒu | harbour



栈桥 zhànqiáo | pier



防波堤 fángbōdī  
jetty



船厂 chuánchǎng  
shipyard



灯塔 dēngtǎ  
lighthouse

塔灯  
tǎdēng  
lamp



浮标 fúbiāo  
buoy

词汇 cíhuì • vocabulary

海岸警卫队  
hǎi'àn jǐngwèidui  
coastguard

港务局长  
gǎngwù júzhǎng  
harbour master

抛锚  
pāomáo  
drop anchor (v)

干船坞  
gānchuánwù  
dry dock

停泊  
tíngbó  
moor (v)

进入船坞  
jìnrùchuánwù  
dock (v)

上船  
shàngchuán  
board (v)

离船登岸  
líchuándēng'àn  
disembark (v)

起航  
qǐháng  
set sail (v)









体育运动 tǐyù yùndòng  
sports



# 美式橄榄球 měishì gǎnlǎnqiú • American football

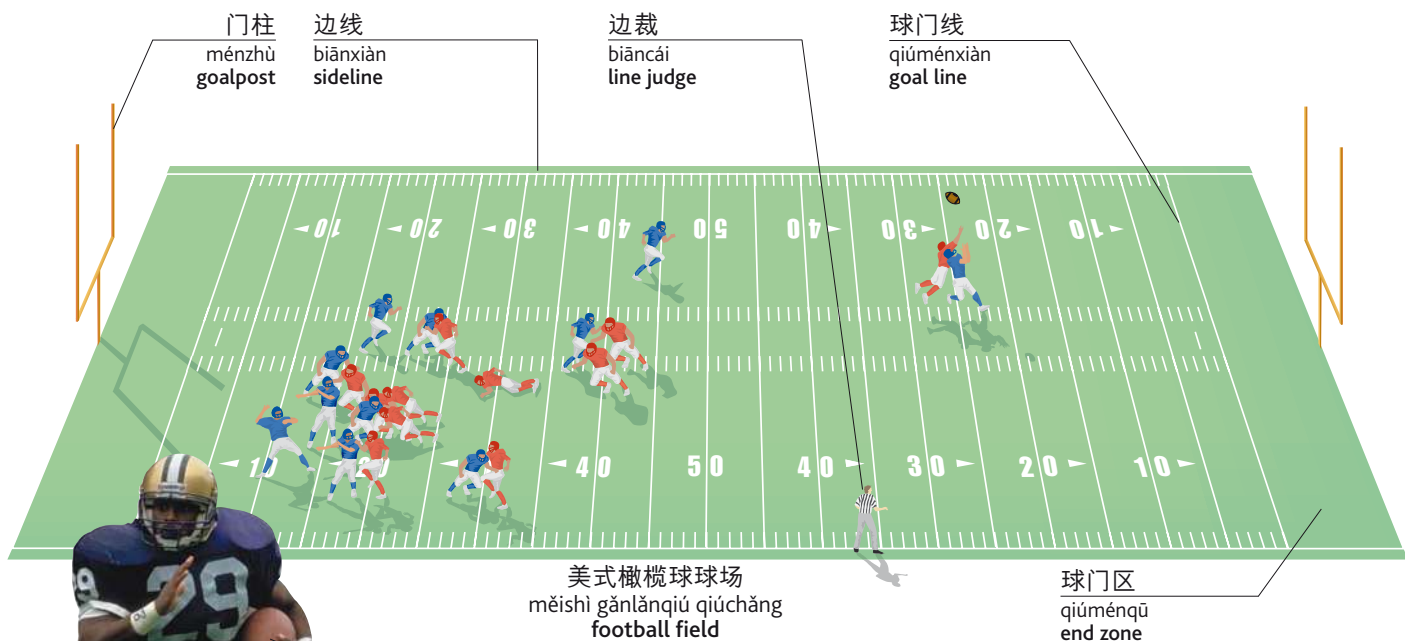

球员 qiúyuán football player

橄榄球 gǎnlǎnqiú football

球鞋 qiúxié boot

护膝 hùxī pads

头盔 tóukuī helmet



擒抱 qínbào tackle (v)



传球 chuánqiú pass (v)



接球 jiēqiú catch (v)

## 词汇 cíhuì • vocabulary

暂停 zàntíng  
time out

球队 qiúduì  
team

防守 fángshǒu  
defence

啦啦队长 lālādúicháng  
cheerleader

几比几? jǐbǐjǐ?  
What is the score?

漏接 lòujiē  
fumble

进攻 jìngōng  
attack

分数 fēnshù  
score

触地得分 chùdìdéfēn  
touchdown

谁领先? shuí lǐngxiān?  
Who is winning?

# 英式橄榄球 yīngshì gǎnlǎnqiú • rugby

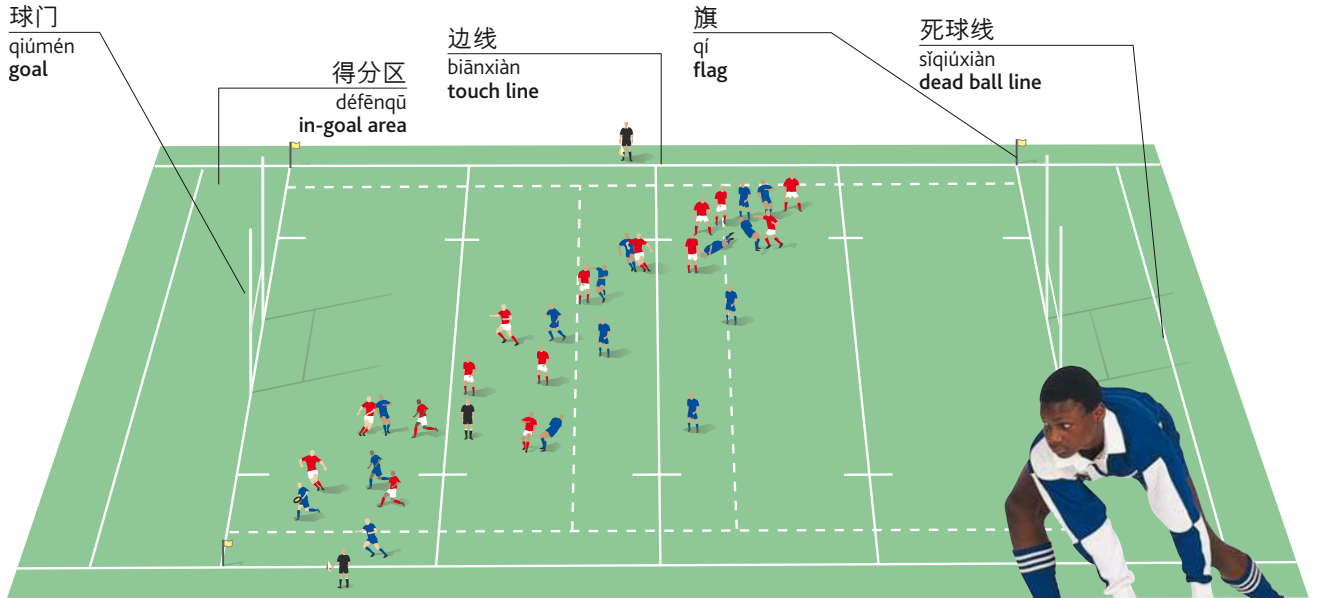

英式橄榄球场 yīngshì gǎnlǎnqiú qiúchǎng | rugby pitch



抛球 pāoqiú throw (v)

球 qiú ball



踢球 tīqiú kick (v)

(英式)橄榄球球衣 (yīngshì) gǎnlǎnqiú qiúyī rugby strip



传球 chuánqiú pass (v)



擒抱 qínbào tackle (v)



持球触地得分 chíqiú chùdìdéfēn try



密集争球 mìjī zhēngqiú | ruck

球员 qiúyuán player



并列争球 bìngliè zhēngqiú | scrum



# 足球 zúqiú • soccer

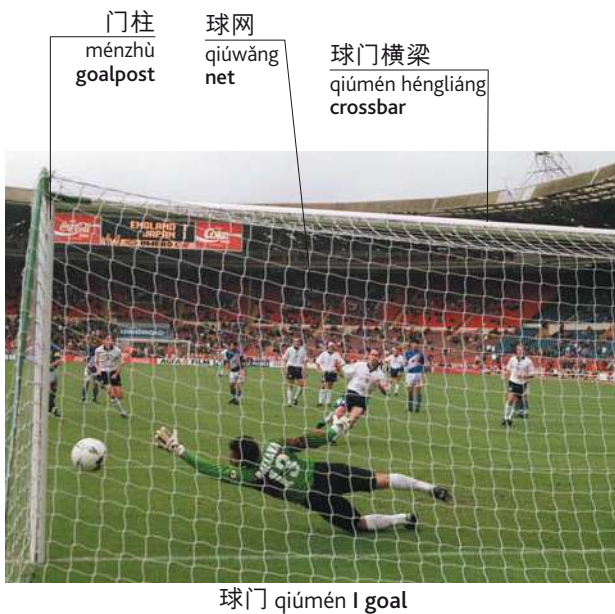
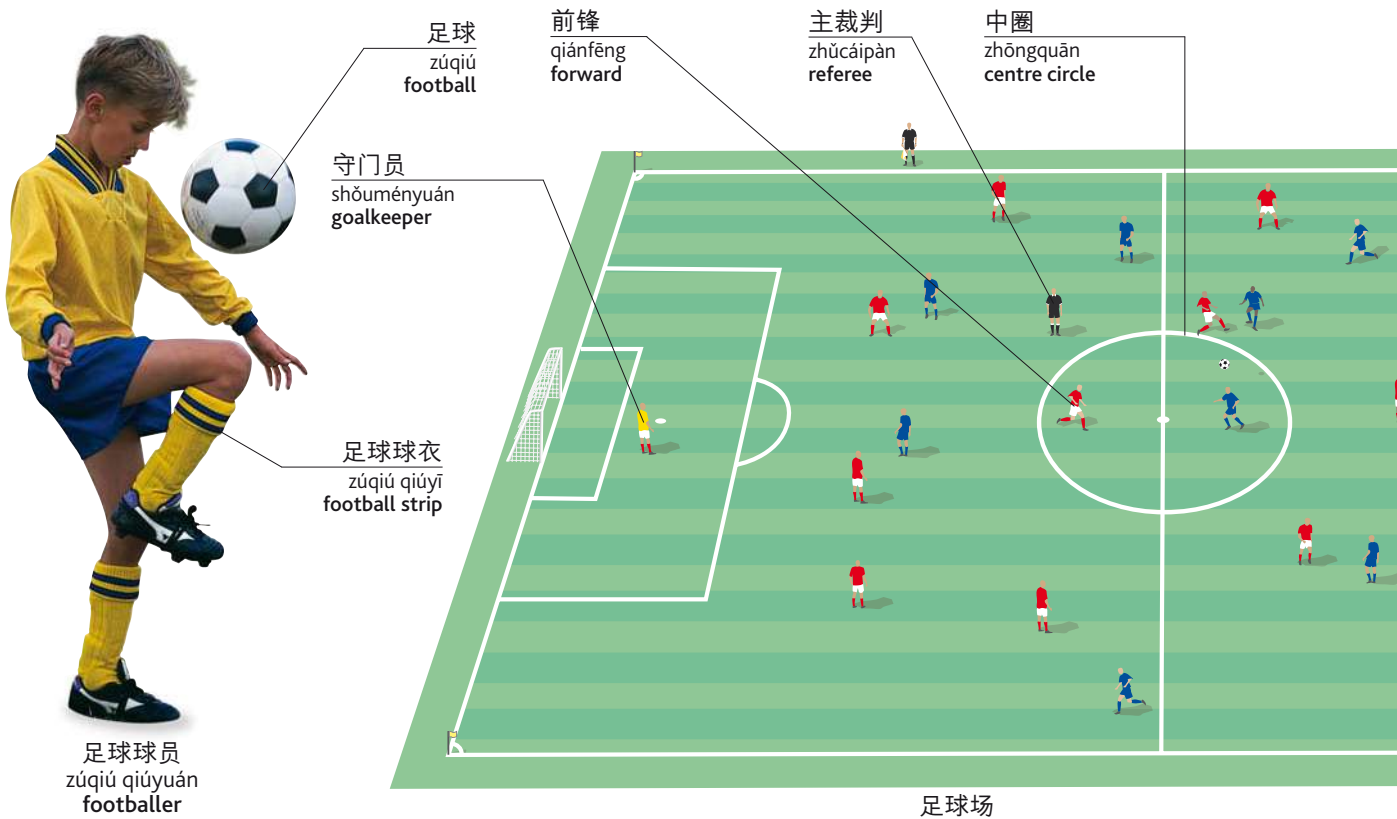

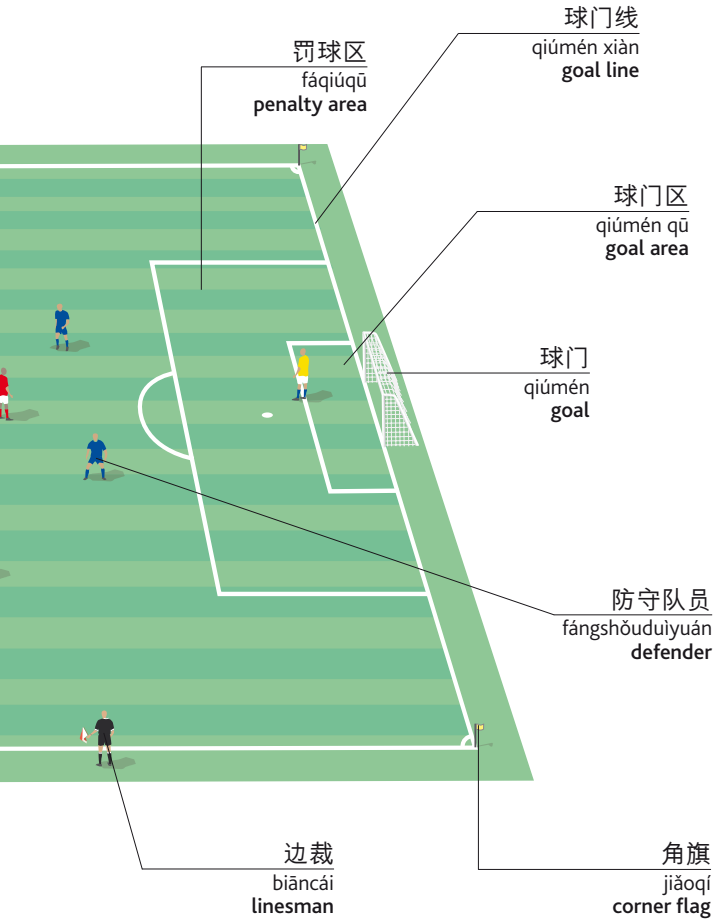

掷界外球 zhìjièwàiqiú  
throw-in



踢球 tīqiú | kick (v)



传球 chuánqiú  
pass (v)

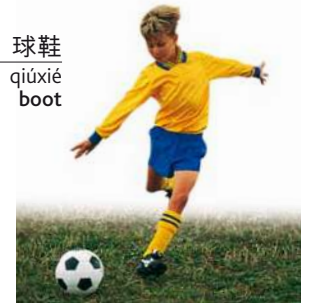

球鞋 qiúxié  
boot

射门 shèmén  
shoot (v)



救球 jiùqiú  
save (v)

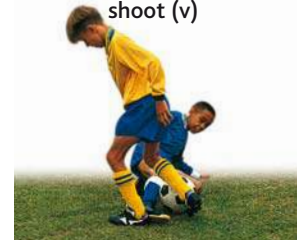

铲球 chǎnqiú  
tackle (v)

词汇 cíhuì • vocabulary

体育场  
tiyùchǎng  
stadium

犯规  
fànguī  
foul

黄牌  
huángpái  
yellow card

联赛  
liánsài  
league

加时  
jiāshí  
extra time

进球得分  
jìnqiúdéfēn  
score a goal (v)

角球  
jiǎoqiú  
corner

越位  
yuèwèi  
off-side

平局  
píngjú  
draw

替补队员  
tìbǔduìyuán  
substitute

罚点球  
fádiǎnqiú  
penalty

红牌  
hóngpái  
red card

罚出场外  
fáchūchǎngwài  
send off

半场  
bànchǎng  
half time

换人  
huànrén  
substitution



# 曲棍类运动 qǔgùnlèi yùndòng • hockey

## 冰球 bīngqiú • ice hockey



## 曲棍球 qūgùnqiú • field hockey

曲棍球棒 qūgùnqiú bàng hockey stick



冰球 bīngqiú puck

冰球球员 bīngqiú qiúyuán ice hockey player



滑行 huáxíng skate (v)



击球 jīqiú hit (v)

# 板球 bǎnqiú • cricket

三门柱 sānménzhù wicket

击球手 jīqiúshǒu batsman

击球线 jīqiúxiàn crease

边线 biānxiàn boundary line

投球手 tóuqiúshǒu bowler

击球 jīqiú bat (v)

接球 jiēqiú field (v)

守门员 shǒuményuán wicket-keeper

落球区 luòqiúqū pitch

防护面具 fánghùmiànjù face mask

球棒 qiúbàng bat

(三柱门的)柱 (sānzhùménde) zhù stump

护腿 hùtuǐ leg pad

板球球员 bǎnqiú qiúyuán cricketer

词汇 cíhuì • vocabulary		
出局 chūjú out	记分牌 jìfēnpái scoreboard	裁判 cáipàn umpire



# 篮球 lánqiú • basketball

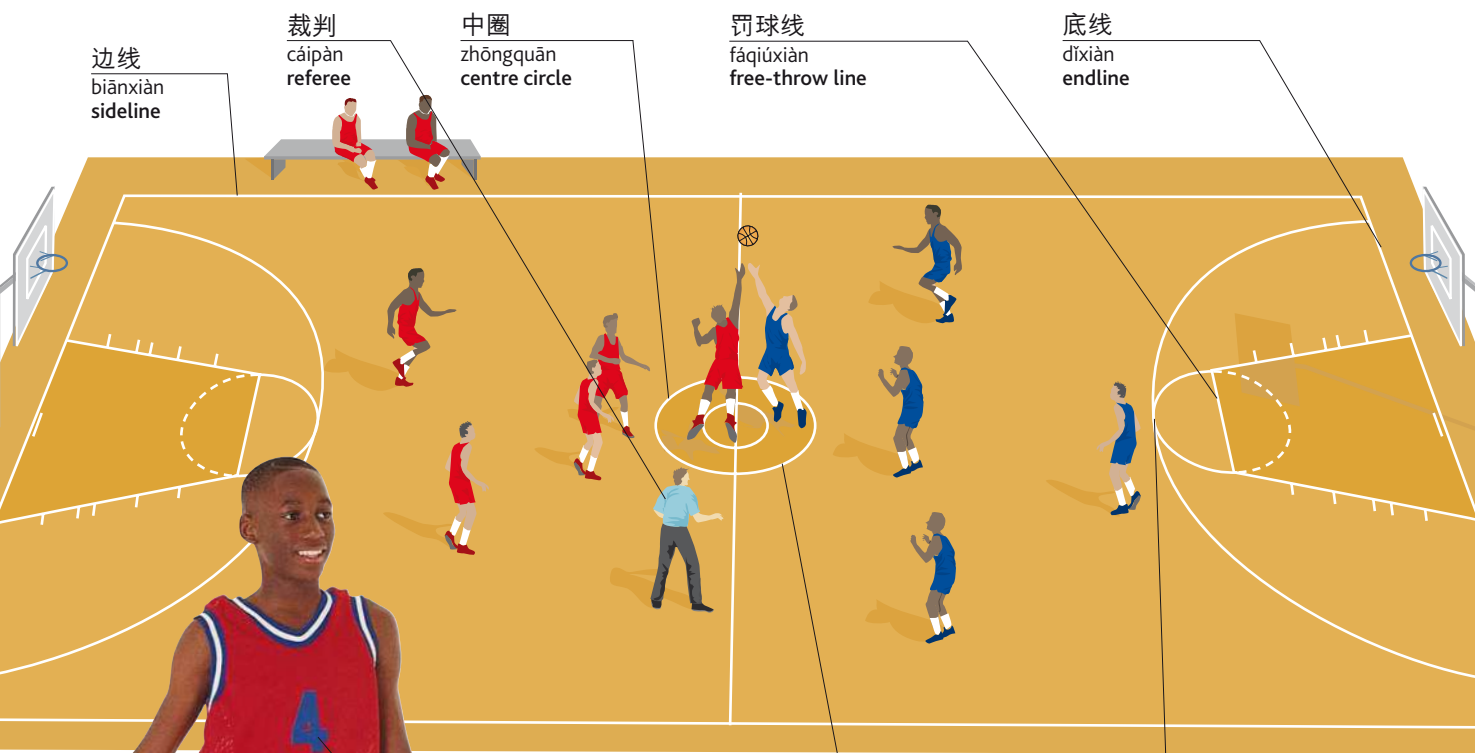

球场 qiúchǎng | court

中线  
zhōngxiàn  
centreline

三分线  
sānfēnxiàn  
three-point line

球衣号  
qiúyīhào  
number

篮板  
lánbǎn  
backboard

篮球  
lánqiú  
ball

篮圈  
lánquān  
hoop

球网  
qiúwǎng  
net

球篮  
qiúlán  
basket

篮球球员 lánqiú qiúyuán | basketball player

## 词汇 cíhuì • vocabulary

传球  
chuánqiú  
pass

掷界外球  
zhìjièwàiqiú  
throw-in

犯规  
fànguī  
foul

跳球  
tiàoqiú  
jump ball

篮板球  
lánbǎnqiú  
rebound

出界  
chūjiè  
out of bounds

动作 dòngzuò • actions



掷球  
zhìqiú  
throw (v)



接球  
jiēqiú  
catch (v)



投篮  
tóulán  
shoot (v)



跳投  
tiàotóu  
jump (v)



灌篮  
guànlán  
dunk (v)



盯人  
dīng rén  
mark (v)



阻挡  
zǔdǎng  
block (v)



运球  
yùnqiú  
bounce (v)



排球 páiqiú • volleyball

拦网  
lánwǎng  
block (v)

球网  
qiúwǎng  
net

垫球  
diànqiú  
dig (v)

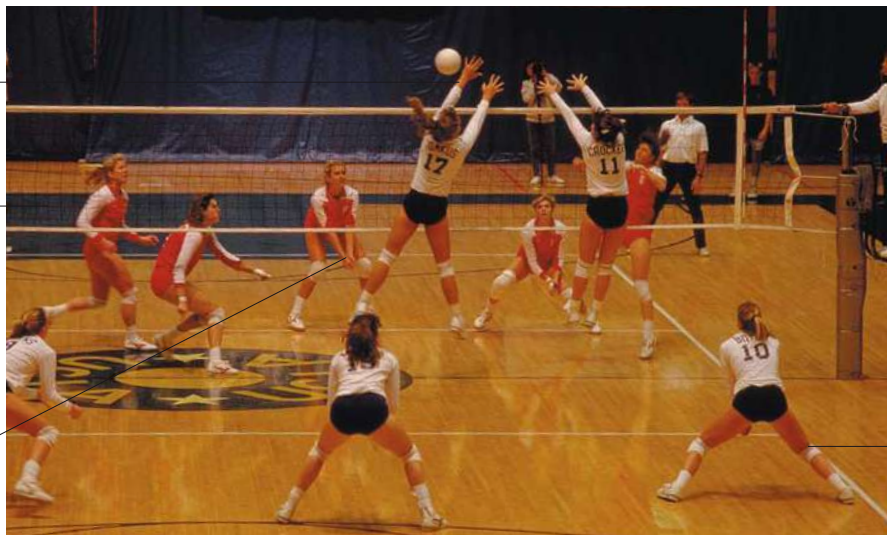

裁判  
cáipàn  
referee

护膝  
hùxī  
knee support

球场 qiúchǎng | court



# 棒球 bàngqiú • baseball

## 球场 qiúchǎng • field

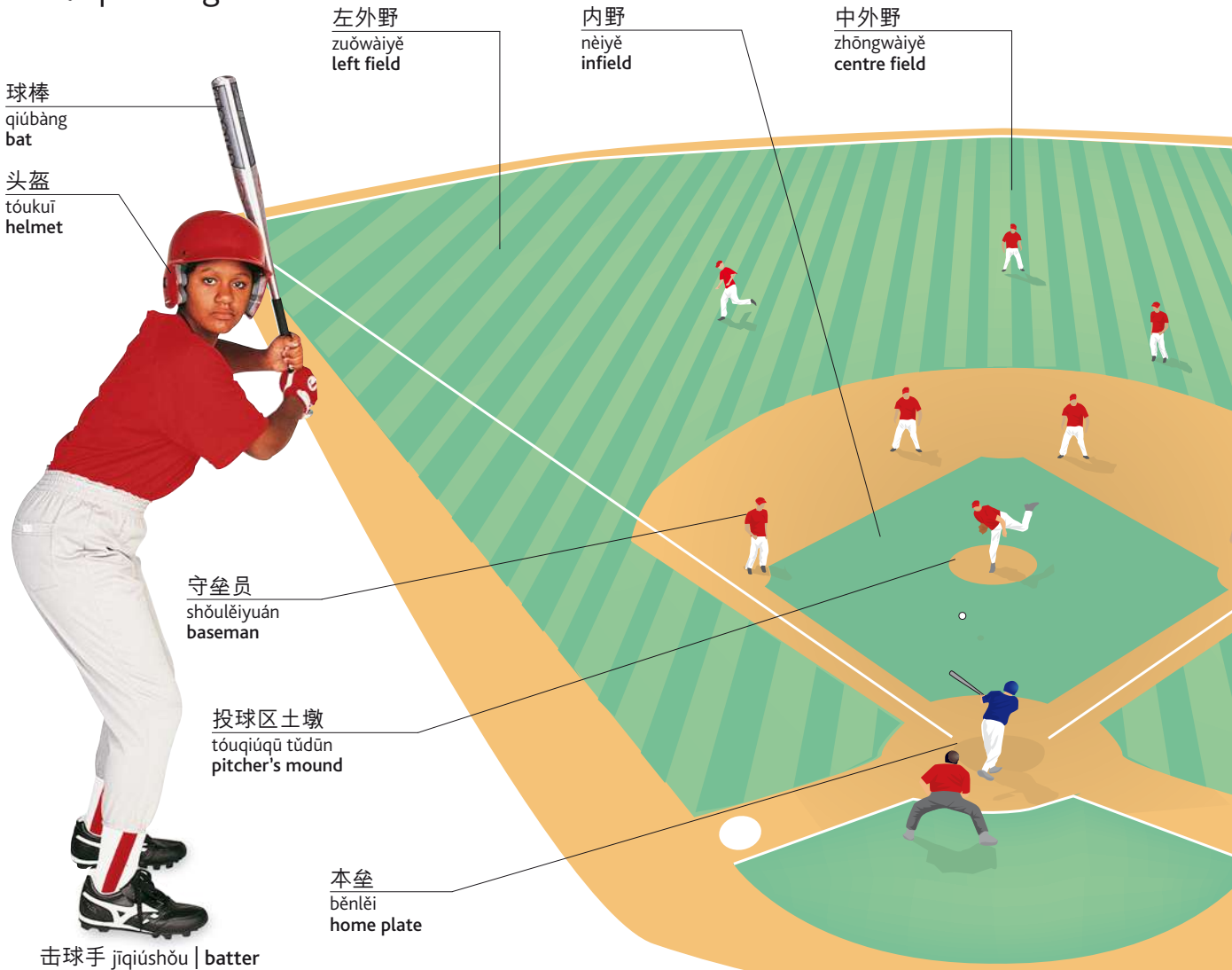

### 词汇 cíhuì • vocabulary

击球局  
jīqiújú  
inning

安全上垒  
ānquánshànglěi  
safe

界外球  
jièwàiqiú  
foul ball

得分  
défēn  
run

出局  
chūjú  
out

好球  
hǎoqiú  
strike



棒球手套 bàngqiú shǒutào  
mitt

棒球  
bàngqiú  
ball



防护面具 fánghùmiànjù  
mask

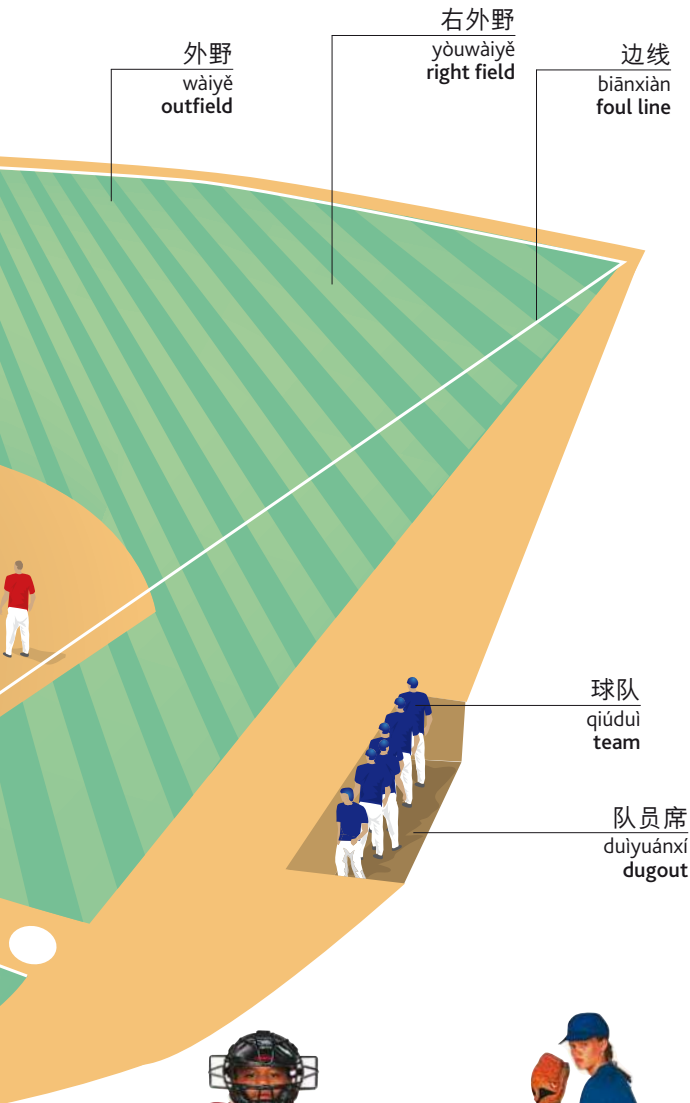

接球手 jiēqiúshǒu | catcher



投手手 tóuqiúshǒu | pitcher

动作 dòngzuò • actions



投球 tóuqiú | throw (v)

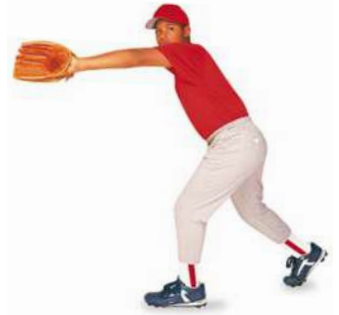

接球 jiēqiú | catch (v)



跑垒 pǎolěi  
run (v)



守球 shǒuqiú | field (v)



滑垒 huálēi  
slide (v)

触杀 chùshā  
tag (v)

投球 tóuqiú  
pitch (v)

击球 jīqiú  
bat (v)

裁判 cáipàn  
umpire



比赛 bǐsài | play (v)



# 网球 wǎngqiú • tennis

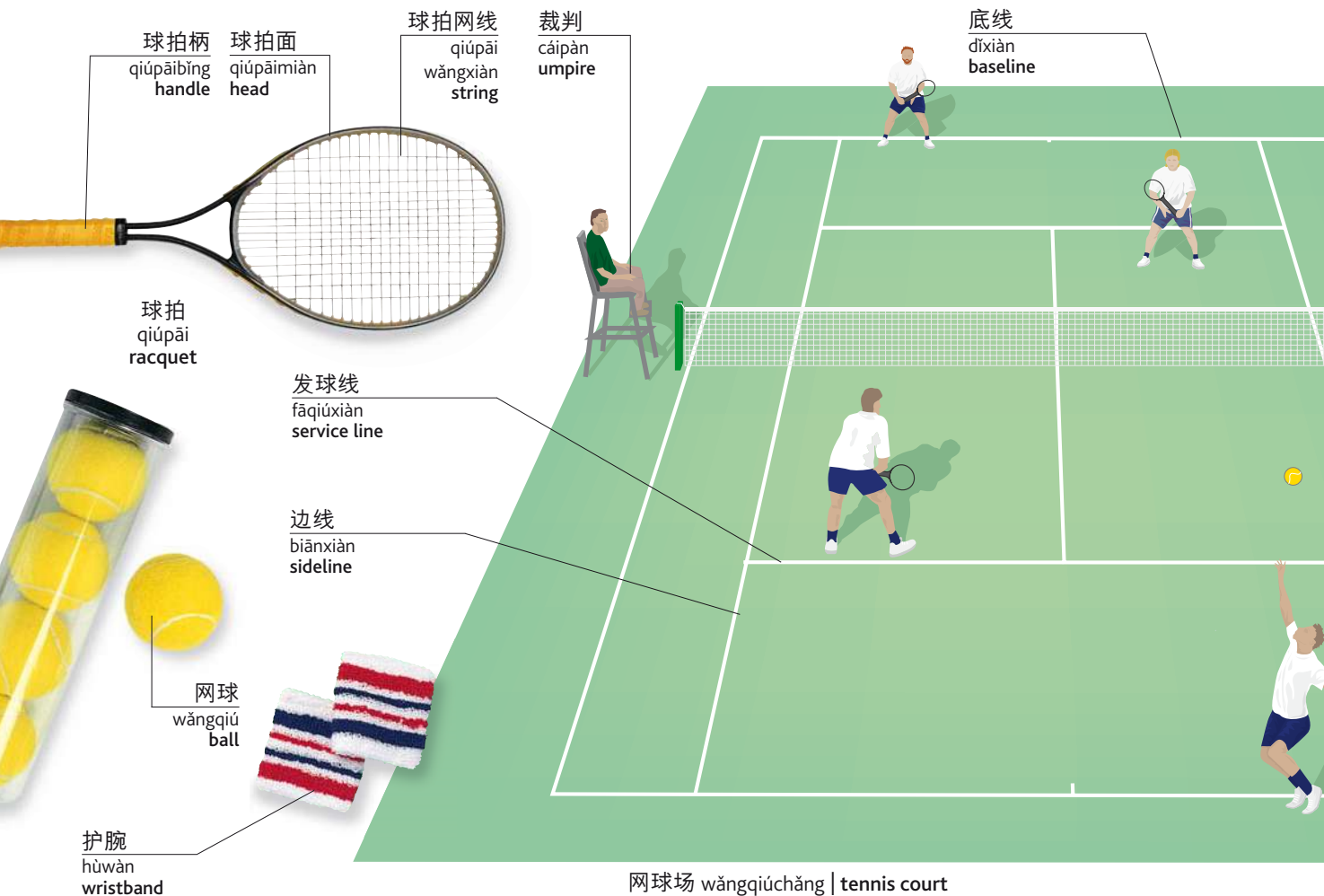

网球场 wǎngqiúchǎng | tennis court

## 词汇 cíhuì • vocabulary

单打  
dāndǎ  
singles

盘, 局  
pán, jú  
set

零分  
língfēn  
love

发球失误  
fāqiúshīwù  
fault

削球  
xiāoqiú  
slice

边裁  
biāncái  
linesman

双打  
shuāngdǎ  
doubles

比赛  
bǐsài  
match

评分  
píngfēn  
deuce

发球得分  
fāqiúdéfēn  
ace

回合  
huíhé  
rally

锦标赛  
jīnbiāosài  
championship

比赛  
bǐsài  
game

抢七局  
qiǎngqījú  
tiebreak

发球方占先  
fāqiúfāng  
zhànxiān  
advantage

近网短球  
jìnwǎng  
duǎnqiú  
dropshot

触网!  
chùwǎng!  
let!

(球在空中)旋转  
(qiú zài kōng zhōng)  
xuánzhuǎn  
spin

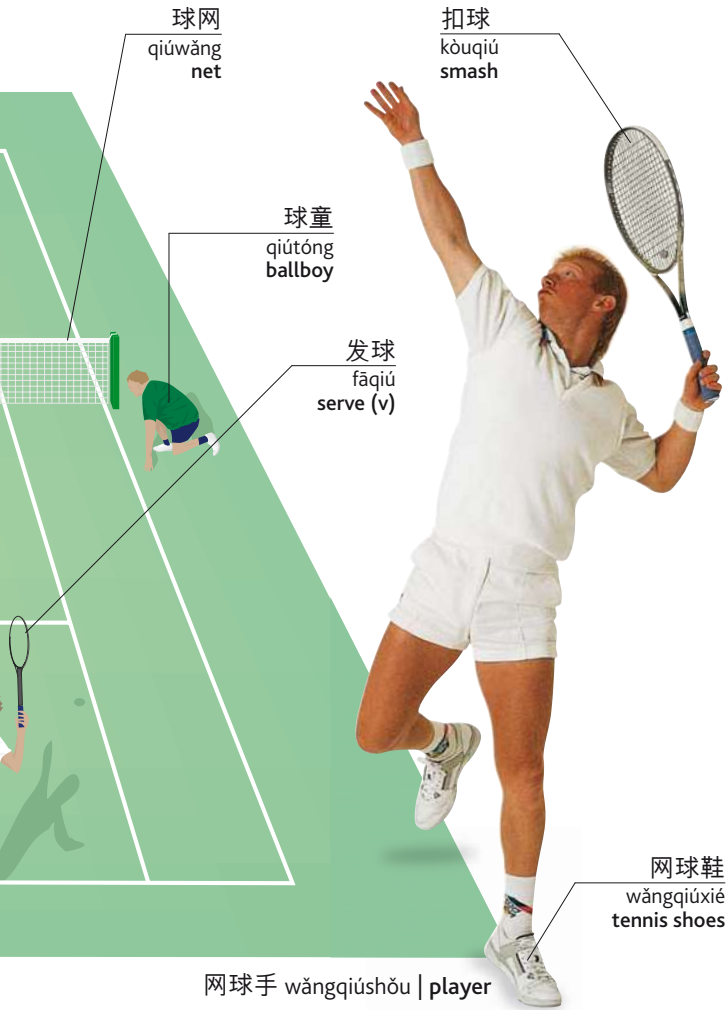

网球手 wǎngqiúshǒu | player

击球动作 jīqiúdòngzuò • strokes



发球 fāqiú serve

拦击球 lánjīqiú volley



回球 huíqiú return



吊高球 diàogāoqiú lob



正手 zhèngshǒu forehand



反手 fǎnshǒu backhand

拍类运动 pāilèi yùndòng • racquet games



羽毛球 yǔmáoqiú shuttlecock



乒乓球拍 pīngpāngqiúpāi bat

羽毛球(运动) yǔmáoqiú (yùndòng) badminton

乒乓球 pīngpāngqiú table tennis



壁球 bìqiú squash



短拍壁球 duǎnpāibìqiú racquetball



# 高尔夫球 gāo'ěrfūqiú • golf



高尔夫球员 gāo'ěrfū qiúyuán | golfer

会所 huìsuǒ | clubhouse

球具 qiújù • equipment



高尔夫球杆 gāo'ěrfū qiúgān  
• golf clubs



动作 dòngzuò • actions



词汇 cíhuì • vocabulary

一杆入洞  
yīgān rùdòng  
hole in one

标准杆数  
biāozhǔn gānshù  
par

差点  
chàdiǎn  
handicap

球童  
qiútóng  
caddy

向后挥杆  
xiàng hòu huīgān  
backswing

击球  
jīqiú  
stroke

低于标准杆数  
dīyú biāozhǔn  
gānshù  
under par

高于标准杆数  
gāoyú biāozhǔn  
gānshù  
over par

巡回赛  
xúnhuísài  
tournament

观众  
guānzhòng  
spectators

练习挥杆  
liànxí huīgān  
practice swing

打球线  
dǎqiúxiàn  
line of play



# 田径运动 tiánjìng yùndòng • athletics

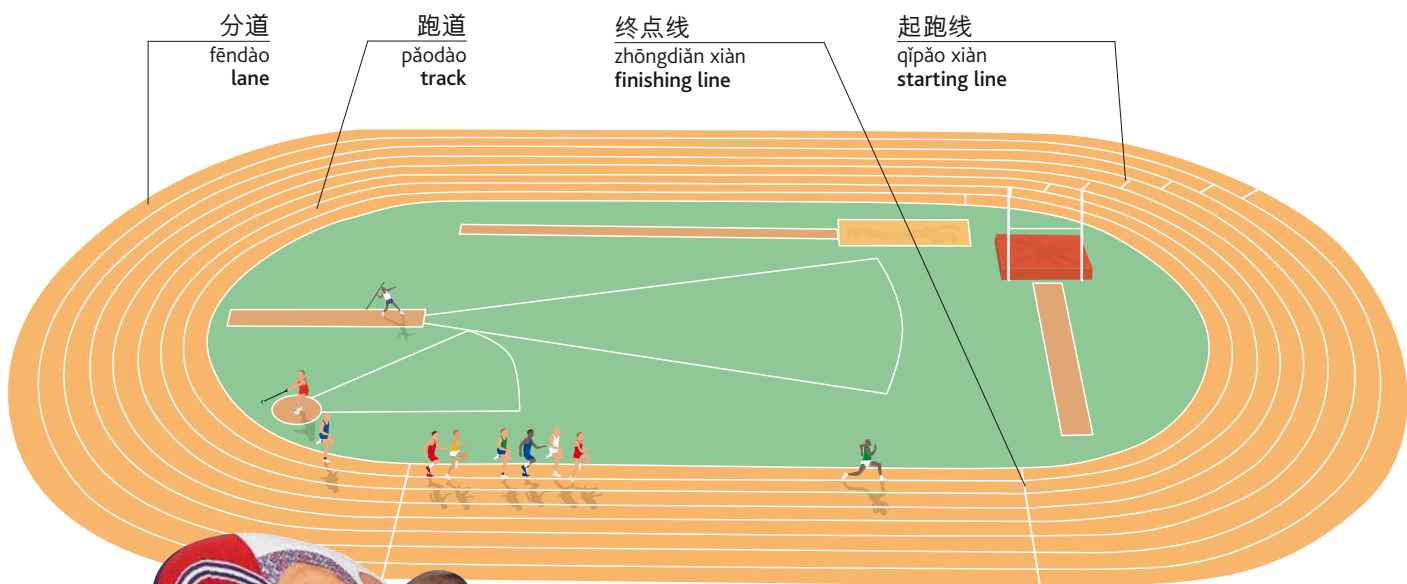

起跑器 qǐpǎoqì starting blocks

短跑选手 duǎnpǎo xuǎnshǒu sprinter



铁饼 tiěbǐng discus

运动场 yùndòngchǎng field

田径选手 tiánjìng xuǎnshǒu athlete



铅球 qiānqiú shotput



标枪 biāoqiāng javelin

## 词汇 cíhuì • vocabulary

赛跑 sàipǎo race

纪录 jìlù record

终点摄影记录 zhōngdiǎn shèyǐng jìlù photo finish

撑杆跳 chēnggāntiào pole vault

时间 shíjiān time

打破纪录 dǎpò jìlù break a record (v)

马拉松 mǎlāsōng marathon

个人最好成绩 gèrén zuìhǎo chéngjì personal best



秒表 miǎobiǎo stopwatch

接力棒  
jiēlibàng  
baton



接力  
jiēli  
relay race

横杆  
hénggān  
crossbar



跳高  
tiàogāo  
high jump



跳远  
tiàoyuǎn  
long jump



跨栏  
kuàlán  
hurdles

## 体操 tǐcāo • gymnastics

跳板  
tiàobǎn  
springboard



空翻  
kōngfān  
somersault



垫子  
diànzi  
mat

自由体操  
zìyóutǐcāo  
floor exercises

体操选手  
tǐcāo xuǎnshǒu  
gymnast



平衡木 pínghéngmù | beam

丝带  
sīdài  
ribbon



翻筋斗  
fānjīndǒu  
tumble



艺术体操  
yìshù tǐcāo  
rhythmic gymnastics

跳马  
tiàomǎ  
horse



跳马(项目)  
tiàomǎ (xiàngmù)  
vault

## 词汇 cíhuì • vocabulary

单杠  
dāngàng  
horizontal bar

鞍马  
ānmǎ  
pommel horse

吊环  
diàohuán  
rings

奖牌  
jiǎngpái  
medals

银牌  
yínpái  
silver

双杠  
shuānggàng  
parallel bars

高低杠  
gāodīgàng  
asymmetric bars

领奖台  
lǐngjiǎngtái  
podium

金牌  
jīnpái  
gold

铜牌  
tóngpái  
bronze



# 格斗运动 gédòu yùndòng • combat sports

对手  
duìshǒu  
opponent

护盔  
hùkuī  
guard

手套  
shǒutào  
glove

腰带  
yāodài  
belt

跆拳道 táiquándào | tae-kwon-do

空手道 kōngshǒudào | karate

柔道 róudào | judo

防护面具  
fánghùmiànjù  
mask

竹剑  
zhújiàn  
sword

中国武术 zhōngguówǔshù  
kung fu

合气道 héqìdào | aikido

剑道 jiàndào | kendo



泰拳 tàiquán | kickboxing

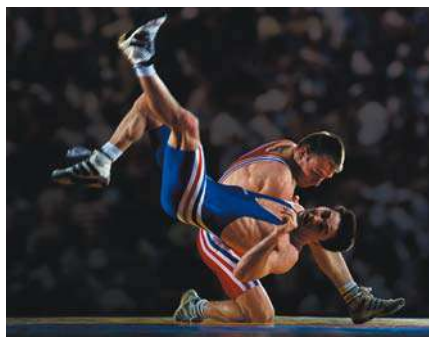

摔跤 shuāijiāo | wrestling



拳击 quánjī | boxing

动作 dòngzuò • actions



摔倒 shuāidǎo | fall



抓握 zhuāwò | hold



摔 shuāi | throw



压倒 yādǎo | pin



侧踢 cètī | kick



出拳 chūquán | punch



击打 jīdǎ | strike



劈 pī | chop



跳踢 tiàotī | jump



挡 dǎng | block

词汇 cíhuì • vocabulary

拳击台  
quánjī tái  
boxing ring

回合  
huíhé  
round

拳头  
quántóu  
fist

黑带  
hēidài  
black belt

卡波卫勒舞  
kǎbōwèilèwǔ  
capoeira

拳击手套  
quánjī shǒutào  
boxing gloves

拳击比赛  
quánjī bǐsài  
bout

击倒 (对手)  
jīdǎo (duìshǒu)  
knock out

自卫  
zìwèi  
self defence

相扑  
xiàngpū  
sumo wrestling

护齿  
hùchǐ  
mouth guard

拳击练习  
quánjī liànxí  
sparring

沙袋  
shādài  
punch bag

武术  
wǔshù  
martial arts

太极拳  
tàijíquán  
tai-chi



# 游泳 yóuyǒng • swimming

## 泳具 yǒngjù • equipment



臂漂  
bìpiāo  
armband



游泳镜 yóuyǒngjìng | goggles

鼻夹  
bíjiá  
nose clip



浮板 fúbǎn | float



泳衣 yǒngyī | swimsuit

泳道  
yǒngdào  
lane

池水  
chíshuǐ  
water

出发台  
chūfāttái  
starting block



游泳池 yóuyǒngchí | swimming pool

泳帽  
yǒngmào  
cap

泳裤  
yǒngkù  
trunks



游泳选手 yóuyǒng xuǎnshǒu | swimmer

跳板  
tiàobǎn  
springboard

跳水选手  
tiàoshuǐ xuǎnshǒu  
diver



跳水 tiàoshuǐ | dive (v)



游泳 yóuyǒng | swim (v)



转身 zhuǎnshēn | turn

## 泳姿 yǒngzī • styles



自由泳 zìyóuyǒng | front crawl



蛙泳 wāyǒng | breaststroke



仰泳 yǎngyǒng | backstroke

划水  
huáshuǐ  
stroke



蝶泳 diéyǒng | butterfly

打水  
dǎshuǐ  
kick

## 水肺潜水 shuǐfèi qiǎnshuǐ • scuba diving

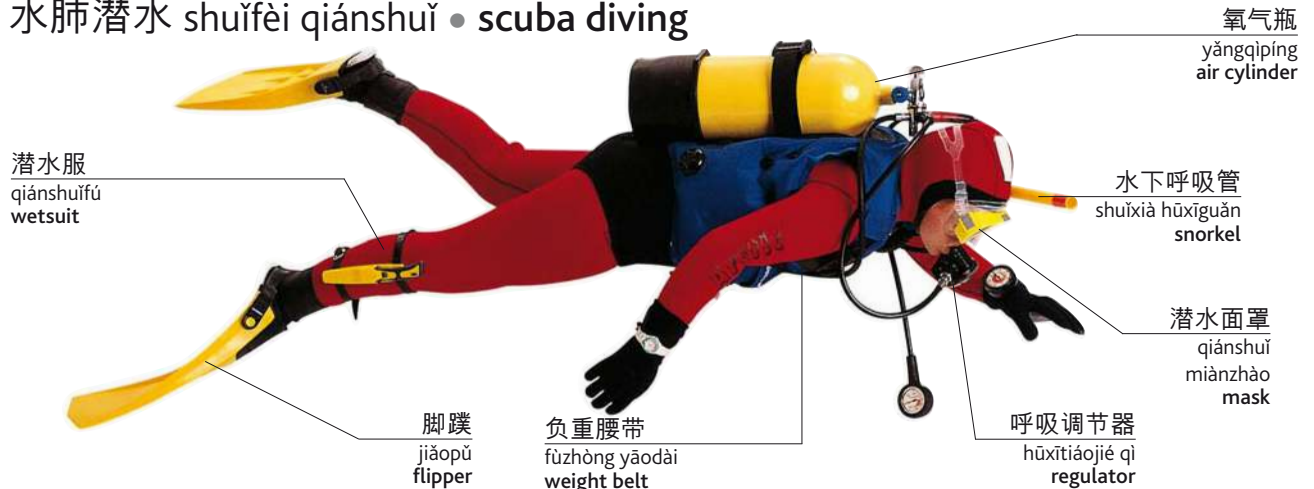

潜水服  
qiǎnshuǐfú  
wetsuit

脚蹼  
jiǎopǔ  
flipper

负重腰带  
fùzhòng yāodài  
weight belt

氧气瓶  
yǎngqìpíng  
air cylinder

水下呼吸管  
shuǐxià hūxīgǎn  
snorkel

潜水面罩  
qiǎnshuǐ  
miànzhào  
mask

呼吸调节器  
hūxītíjiéqì  
regulator

### 词汇 cíhuì • vocabulary

跳水  
tiàoshuǐ  
dive

踩水  
cǎishuǐ  
tread water (v)

锁柜  
suǒguì  
lockers

水球  
shuǐqiú  
water polo

浅水区  
qiǎnshuǐqū  
shallow end

抽筋  
chōujīn  
cramp

高台跳水  
gāotái tiàoshuǐ  
high dive

出发跳水  
chūfā tiàoshuǐ  
racing dive

救生员  
jiùshēngyuán  
lifeguard

深水区  
shēnshuǐqū  
deep end

花样游泳  
huāyàng yóuyǒng  
synchronized swimming

溺水  
nìshuǐ  
drown (v)



# 帆船运动 fānchuán yùndòng • sailing



指南针  
zhǐnánzhēn  
compass



锚  
máo  
anchor

系索耳  
xìsuǒ'ěr  
cleat

侧舷  
cèxián  
sidedeck

艄三角帆  
shōusān jiǎofān  
headsail

船头  
chuántóu  
bow

舵柄  
duòbǐng  
tiller

船体  
chuántǐ  
hull

桅杆  
wéigān  
mast

帆缆  
fānlǎn  
rigging

主帆  
zhǔfān  
mainsail

帆桁  
fānhéng  
boom

船尾  
chuánwěi  
stern



航行 hángxíng | navigate (v)



帆船 fānchuán | yacht

## 救生器具 jiùshēngqìjù • safety



照明弹  
zhàomíngdàn  
flare



救生圈  
jiùshēngquān  
lifebuoy



救生衣  
jiùshēngyī  
life jacket



救生筏  
jiùshēngfá  
life raft

# 水上运动 shuǐshàng yùndòng • watersports



桨手  
jiǎngshǒu  
rower

桨  
jiǎng  
oar

划船 huáchuán | row (v)



皮筏  
pífá  
kayak

双叶桨  
shuāngyèjiǎng  
paddle

独木舟  
dúmùzhōu  
canoeing



帆  
fān  
sail

帆板运动员  
fānbǎn  
yùndòngyuán  
windsurfer

帆板  
fānbǎn  
board

帆板运动 fānbǎn yùndòng | windsurfing

冲浪板  
chōnglàngbǎn  
surfboard



冲浪  
chōnglàng  
surfing

滑水橇  
huáshuǐqiāo  
ski



滑水  
huáshuǐ  
waterskiing



快艇  
kuàitǐng  
speed boating

套脚带  
tàojiǎodài  
footstrap



皮划艇  
píhuá艇  
rafting



水上摩托  
shuǐshàng mótuō  
jet skiing

## 词汇 cíhuì • vocabulary

滑水者  
huáshuǐzhě  
waterskier

艇员  
tǐngyuán  
crew

风  
fēng  
wind

浪花  
lànghuā  
surf

帆脚索  
fānjiǎosuǒ  
sheet

稳向板  
wěnniàngbǎn  
centreboard

冲浪运动员  
chōnglàng yùndòngyuán  
surfer

抢风航行  
qiǎngfēng hángxíng  
tack (v)

波浪  
bōlàng  
wave

激流  
jīliú  
rapids

舵  
duò  
rudder

(船)倾覆  
(chuán) qīngfù  
capsize (v)



# 马上运动 mǎshàng yùndòng • horse riding



赛事 sàishì • events

赛马  
sàimǎ  
racehorse



赛马(比赛)  
sàimǎ (bǐsài)  
horse race

障碍  
zhàng'ài  
fence



障碍赛  
zhàng'aisài  
steeplechase



轻驾车赛  
qīngjiàchēsài  
harness race



牛仔竞技表演  
niúzǎijìngjì biǎoyǎn  
rodeo



越障碍赛  
yuèzhàng'aisài  
showjumping



双套马车赛  
shuāngtào mǎchēsài  
carriage race



长途旅行 chángtú lǚxíng | trekking



花式骑术 huāshìqíshù | dressage



马球 mǎqiú | polo

词汇 cíhuì • vocabulary

慢步  
mànbù  
walk

慢跑  
mànpǎo  
canter

跳跃  
tiàoyuè  
jump

笼头  
lóngtóu  
halter

围场  
wéichǎng  
paddock

无障碍赛马  
wúzhàng'aisàimǎ  
flat race

小跑  
xiǎopǎo  
trot

疾驰  
jíchí  
gallop

马夫  
mǎfū  
groom

马厩  
mǎjiù  
stable

竞技场  
jìngjìchǎng  
arena

赛马场  
sàimǎchǎng  
racecourse



# 钓鱼 diàoyú • fishing



铅坠 qiānzhuì | weight

倒钩  
dǎogōu  
barb



钩眼  
gōuyǎn  
eye



饵 ěr | bait



浮标  
fúbiāo  
float

渔钩  
yúgōu  
fishhook



人造饵  
rénzàoěr  
lure



假蝇  
jiǎyíng  
fly



抄网  
chāowǎng  
landing net



钓具箱  
diàojùxiāng  
tackle box



活鱼笼  
huóyúlóng  
keep net

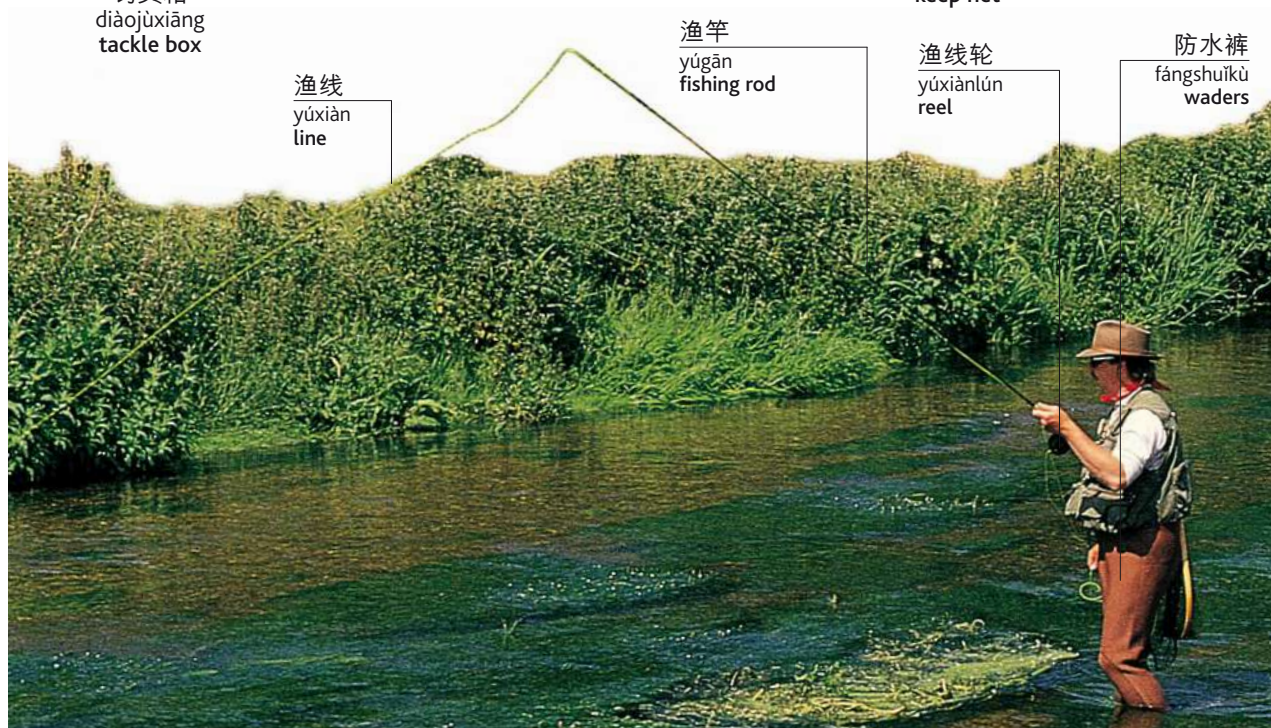

渔线  
yúxiàn  
line

渔竿  
yúgān  
fishing rod

渔线轮  
yúxiànlún  
reel

防水裤  
fángshuǐkù  
waders

钓鱼者 diàoyúzhě | angler

## 垂钓种类 chuídiào zhǒnglèi • types of fishing



淡水垂钓  
dànshuǐ chuídiào  
freshwater fishing



假蝇垂钓  
jiǎyīng chuídiào  
fly fishing



激浪投钓  
jīlàng tóudiào  
surfcasting



休闲垂钓  
xiūxián chuídiào  
sport fishing



深海垂钓  
shēnhǎi chuídiào  
deep sea fishing

## 活动 huódòng • activities



撒网  
sāwǎng  
cast (v)



捕捉  
bǔzhuō  
catch (v)



收线  
shōuxiàn  
reel in (v)



网捕  
wǎngbǔ  
net (v)



放生  
fàngshēng  
release (v)

## 词汇 cíhuì • vocabulary

装饵  
zhuāng'ěr  
bait (v)

钓具  
diàojù  
tackle

雨衣  
yǔyī  
waterproofs

钓鱼许可证  
diàoyú xǔkězhèng  
fishing permit

渔篓  
yúlǒu  
creel

咬钩  
yǎogōu  
bite (v)

线轴  
xiànzhóu  
spool

杆  
gān  
pole

海洋捕捞  
hǎiyáng bǔlāo  
marine fishing

渔叉捕鱼  
yúchābùyú  
spearfishing



# 滑雪 huáxuě • skiing

滑雪坡道  
huáxuě pōdào  
ski slope

缆车吊椅  
lǎnchē diàoqǐ  
chairlift

缆车  
lǎnchē  
cable car

滑雪服  
huáxuěfú  
ski suit

滑雪杖  
huáxuězhàng  
ski pole

手套  
shǒutào  
glove

雪道  
xuědào  
ski run

安全护栏  
ānquánhùlán  
safety barrier

滑雪靴  
huáxuěxié  
ski boot

滑雪板  
huáxuěbǎn  
ski

板边  
bǎnbiān  
edge

板尖  
bǎnjiān  
tip

滑雪者  
huáxuězhě  
skier



项目 xiàngmù • events



高山速降  
gāoshān sùjiàng  
downhill skiing

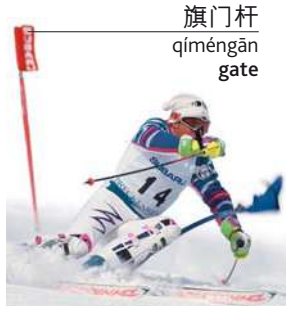

旗门杆  
qíméngān  
gate  
小回转  
xiǎohuízhuǎn  
slalom



跳台滑雪  
tiàotái huáxuě  
ski jump



越野滑雪  
yuèyě huáxuě  
cross-country skiing

冬季运动 dōngjì yùndòng • winter sports



攀冰  
pānbīng  
ice climbing



溜冰  
liūbīng  
ice-skating



花样滑冰  
huāyàng huábing  
figure skating

滑雪镜  
huáxuějìng  
goggles



单板滑雪  
dānbǎn huáxuě  
snowboarding

冰鞋  
bīngxié  
skate



长橇滑雪  
chángqiāo huáxuě  
bobsleigh



小型橇  
xiǎoxíngqiāo  
luge



机动雪橇  
jīdòng xuěqiāo  
snowmobile



乘橇滑行  
chéngqiāo huáxíng  
sledding

词汇 cíhuì • vocabulary

高山滑雪  
gāoshān huáxuě  
alpine skiing

大回转  
dàhuízhuǎn  
giant slalom

雪道外  
xuědàowài  
off-piste

冰上溜石  
bīngshàng liúshí  
curling

狗拉雪橇  
gǒulā xuěqiāo  
dog sledding

速滑  
sùhuá  
speed skating

冬季两项  
dōngjì liǎngxiàng  
biathlon

雪崩  
xuěbēng  
avalanche



# 其他运动 qítāyùndòng • other sports

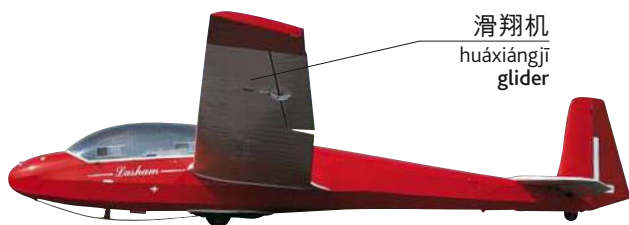

滑翔机  
huáxiángjī  
glider

悬挂式滑翔机  
xuánguàshì  
huáxiángjī  
hang-glider



悬挂滑翔  
xuánguà huáxiáng  
hang-glider

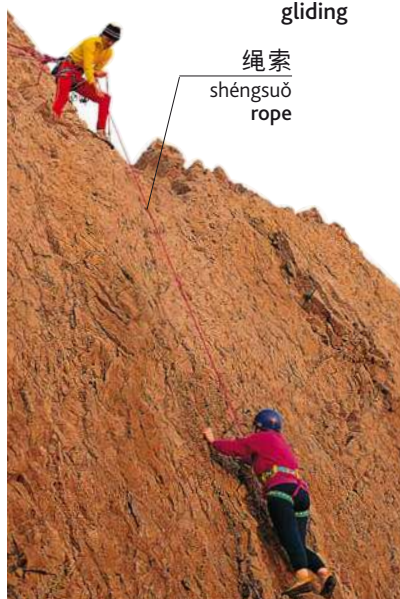

滑翔  
huáxiáng  
gliding

绳索  
shéngsuǒ  
rope

攀岩  
pānyán  
rock climbing



降落伞  
jiàngluòsǎn  
parachute

跳伞  
tiàosǎn  
parachuting



滑翔伞  
huáxiángsǎn  
paragliding



特技跳伞  
tèjìtiàosǎn  
skydiving



悬绳下降  
xuánshéng xiàjiàng  
abseiling



蹦极  
bèngjí  
bungee jumping



汽车拉力赛  
qìchē lālìsài  
rally driving



赛车  
sàichē  
motor racing



摩托车越野赛  
mótuōchē yuèyěsài  
motorcross



摩托车赛  
mótuōchēsài  
motorbike racing



滑板运动  
huábǎn yùndòng  
skateboarding

滑板  
huábǎn  
skateboard

轮滑鞋  
lúnhuáxié  
rollerskate



滑旱冰  
huáhànbing  
roller skating

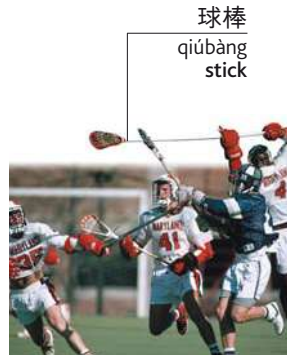

长曲棍球  
cháng qūgùnqiú  
lacrosse

球棒  
qiúbàng  
stick



击剑  
jījiàn  
fencing

面具  
miànjù  
mask

花剑  
huājiàn  
foil



保龄球瓶  
bǎolíngqiú píng  
pin

箭  
jiàn  
arrow

箭袋  
jiàndài  
quiver

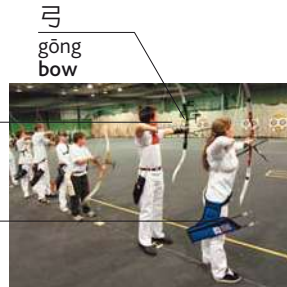

射箭  
shèjiàn  
archery

弓  
gōng  
bow



射击  
shèjī  
target shooting

靶  
bǎ  
target

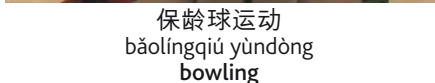

保龄球运动  
bǎolíngqiú yùndòng  
bowling

保龄球  
bǎolíngqiú  
bowling ball



美式台球  
měishítáiqiú  
pool



台球  
táiqiú  
snooker



# 健身 jiànshēn • fitness

健身车  
jiànshēnchē  
exercise bike

力量训练器  
lìliàng xùnliàncì  
free weights

横杠  
hénggàng  
bar

健身器械  
jiànshēn qìxiè  
gym machine

长椅  
chángyǐ  
bench

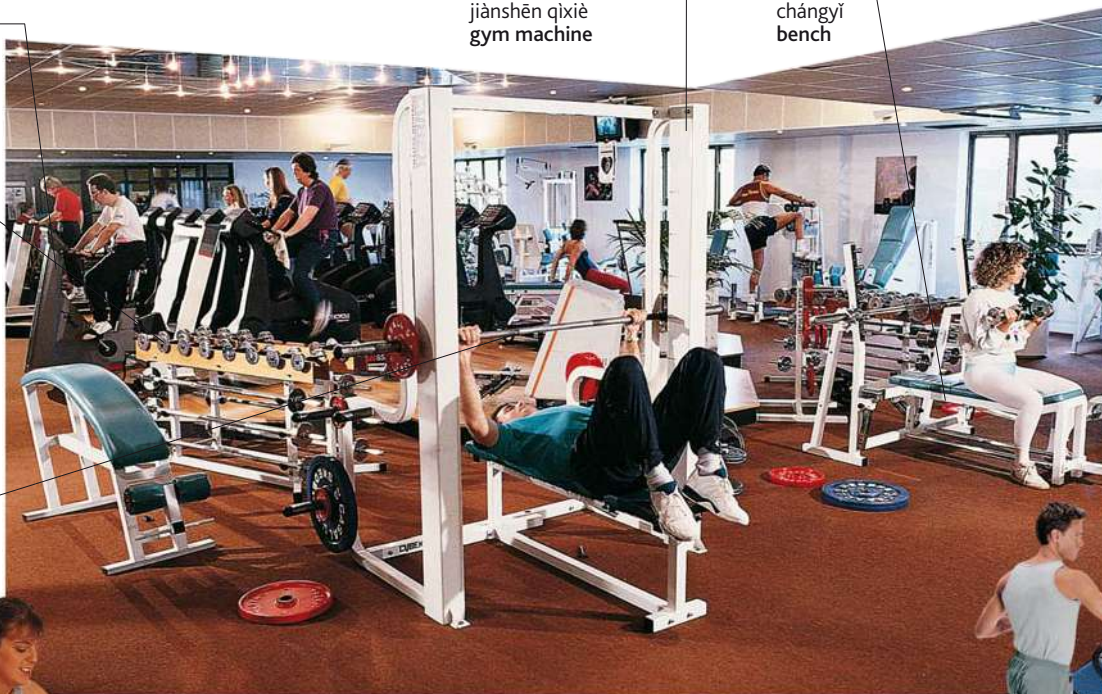

划船机  
huáchuánjī  
rowing machine

健身房  
jiànshēnfáng  
gym



跑步机  
pǎobùjī  
treadmill



交叉训练器  
jiāochā xùnliàncì  
cross trainer



私人教练  
sīrén jiàoliàn  
personal trainer



踏步机  
tàbùjī  
step machine



游泳池  
yóuyǒngchí  
swimming pool



桑拿浴  
sāngnáyù  
sauna

锻炼 duànliàn • exercises



伸展腿  
shēnzhǎntuǐ  
stretch



弓箭步压腿  
gōngjiǎnbù yātuǐ  
lunge

紧身衣  
jǐnshēnyī  
tights



俯卧撑  
fǔwòchēng  
press-up



蹲起  
dūnqǐ  
squat



仰卧起坐  
yǎngwòqǐzuò  
sit-up



二头肌训练  
èrtóujī xùnliàn  
bicep curl

哑铃  
yǎlíng  
dumb bell



蹬腿  
dēngtuǐ  
leg press



扩胸  
kuòxiōng  
chest press



运动鞋  
yùndòngxié  
trainers

杠铃横杆  
gānglíng hénghān  
weight bar

重量训练  
zhòngliàng xùnliàn  
weight training



慢跑  
mànpǎo  
jogging

背心  
bèixīn  
vest



有氧运动  
yǒuyǎng yùndòng  
aerobics

词汇 cíhuì • vocabulary

训练  
xùnliàn  
train (v)

原地跑  
yuándìpǎo  
jog on the spot (v)

伸展  
shēnzhǎn  
extend (v)

普拉提  
pǔlātī  
Pilates

循环训练法  
xúnhuán xùnliàn fǎ  
circuit training

热身  
rèshēn  
warm up (v)

弯曲(四肢)  
wānqū (sìzhī)  
flex (v)

引体向上  
yǐntǐ xiàngshàng  
pull up (v)

搏击操  
bójīcāo  
boxercise

跳绳  
tiàoshéng  
skipping







休闲 xiūxián  
leisure



# 剧院 jùyuàn • theatre



幕  
mù  
curtain

舞台侧翼  
wútaicèyì  
wings

布景  
bùjǐng  
set

观众  
guānzhòng  
audience

乐队  
yuèduì  
orchestra

舞台 wǔtái | stage

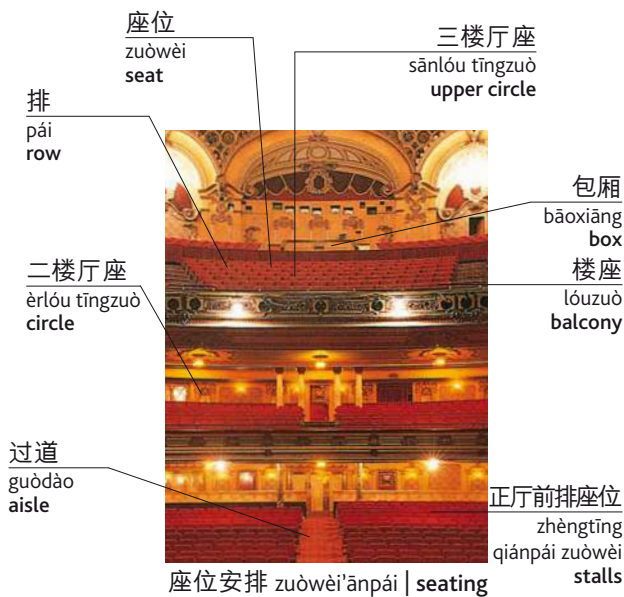

座位  
zuòwèi  
seat

三楼厅座  
sānlóu tīngzuò  
upper circle

排  
pái  
row

包厢  
bāoxiāng  
box

二楼厅座  
èrlóu tīngzuò  
circle

楼座  
lóuzuò  
balcony

过道  
guòdào  
aisle

正厅前排座位  
zhèngtīng  
qiánpái zuòwèi  
stalls

座位安排 zuòwèi'ānpái | seating

## 词汇 cíhuì • vocabulary

角色分配  
juésè fēnpèi  
cast

剧本  
jùběn  
script

首演  
shǒuyǎn  
first night

男演员  
nányǎnyuán  
actor

背景幕布  
bèijǐngmùbù  
backdrop

幕间休息  
mùjiānxiūxi  
interval

女演员  
nǚyǎnyuán  
actress

导演  
dǎoyǎn  
director

节目  
jiémù  
programme

戏剧  
xìjù  
play

制片人  
zhìpiānrén  
producer

乐池  
yuèchí  
orchestra pit



音乐会 yīnyuèhuì | concert



音乐剧 yīnyuèjù | musical

戏装  
xìzhuāng  
costume



芭蕾舞 bālěiwǔ | ballet

词汇 cíhuì • vocabulary

引座员  
yǐnzǔyuán  
usher

声带  
shēngdài  
soundtrack

演出什么时候开始？  
yǎnchū shénme shíhòu kāishǐ?  
What time does it start?

古典音乐  
gǔdiǎn yīnyuè  
classical music

鼓掌喝彩  
gǔzhǎnghècǎi  
applaud (v)

我想要两张今晚演出的票。  
wǒ xiǎng yào liǎngzhāng jīnwǎn  
yǎnchūde piào.  
I'd like two tickets for tonight's  
performance.

乐谱  
yuèpǔ  
musical score

再来一次  
zàiláiyíci  
encore



歌剧 gējù | opera

电影院 diànyǐngyuàn • cinema

爆米花  
bàomǐhuā  
popcorn



大厅  
dàtīng  
lobby

售票处  
shòupiàochù  
box office



海报  
hǎibào  
poster



电影放映厅  
diànyǐng fàngyǐngtīng  
cinema hall



银幕  
yǐnmù  
screen

词汇 cíhuì • vocabulary

喜剧片  
xǐjùpiān  
comedy

爱情片  
àiqíngpiān  
romance

惊险片  
jīngxiǎnpiān  
thriller

科幻片  
kēhuànpīān  
science fiction film

恐怖片  
kǒngbùpiān  
horror film

冒险片  
màoxiǎnpiān  
adventure

西部片  
xībùpiān  
western

动画片  
dònghuàpiān  
animated film



# 乐队 yuèduì • orchestra

## 弦乐器 xiányuèqì • strings



钢琴 gāngqín | piano

乐谱 yuèpǔ score

低音谱号 dīyīn pǔhào bass clef

高音谱号 gāoyīn pǔhào treble clef

音符 yīnfú note

五线谱 wǔxiànpǔ staff



记谱法 jìpǔfǎ | notation

### 词汇 cíhuì • vocabulary

序曲 xùqǔ  
overture

奏鸣曲 zòumíngqǔ  
sonata

休止符 xiūzhǐfú  
rest

升号 shēnghào  
sharp

本位号 běnwèihào  
natural

音阶 yīnjiē  
scale

交响乐 jiāoxiǎngyuè  
symphony

乐器 yuèqì  
instruments

音高 yīngāo  
pitch

降号 jiàngào  
flat

小节线 xiǎojiéxiàn  
bar

指挥棒 zhǐhuībàng  
baton

木管乐器 mùguǎnyuèqì • woodwind



短笛  
duǎndí  
piccolo



长笛  
chángdí  
flute



双簧管  
shuānghuánguǎn  
oboe



英国管  
yīngguóguǎn  
cor anglais



萨克斯管  
sàkèsīguǎn  
saxophone



单簧管  
dānhuánguǎn  
clarinet



低音单簧管  
dīyīn dānhuánguǎn  
bass clarinet



巴松管  
bāsōngguǎn  
bassoon



倍低音管  
bèidīyīnguǎn  
double bassoon

打击乐器 dǎjīyuèqì • percussion



定音鼓  
dīngyīngǔ  
kettledrum



锣  
luó  
gong



邦戈鼓  
bānggēgǔ  
bongos



小军鼓  
xiǎojūngǔ  
snare drum



钹  
bó  
cymbals



铃鼓  
língǔ  
tambourine



颤音琴  
chànyīnqín  
vibraphone



三角铁  
sānjiǎotiě  
triangle



沙锤  
shāchuí  
maracas

铜管乐器 tóngguǎn yuèqì • brass



小号  
xiǎohào  
trumpet



长号  
cháng hào  
trombone



圆号  
yuánhào  
French horn



大号  
dàhào  
tuba



# 音乐会 yīnyuèhuì • concert



麦克风  
màikēfēng  
microphone

主唱  
zhǔchàng  
lead singer

鼓手  
gǔshǒu  
drummer

吉他手  
jítāshǒu  
guitarist

歌迷  
gēmí  
fans

低音吉他手  
dīyīn jítāshǒu  
bass guitarist

扩音器  
kuòyīnqì  
speaker

摇滚音乐会 yáogǔn yīnyuèhuì | rock concert

# 乐器 yuèqì • instruments

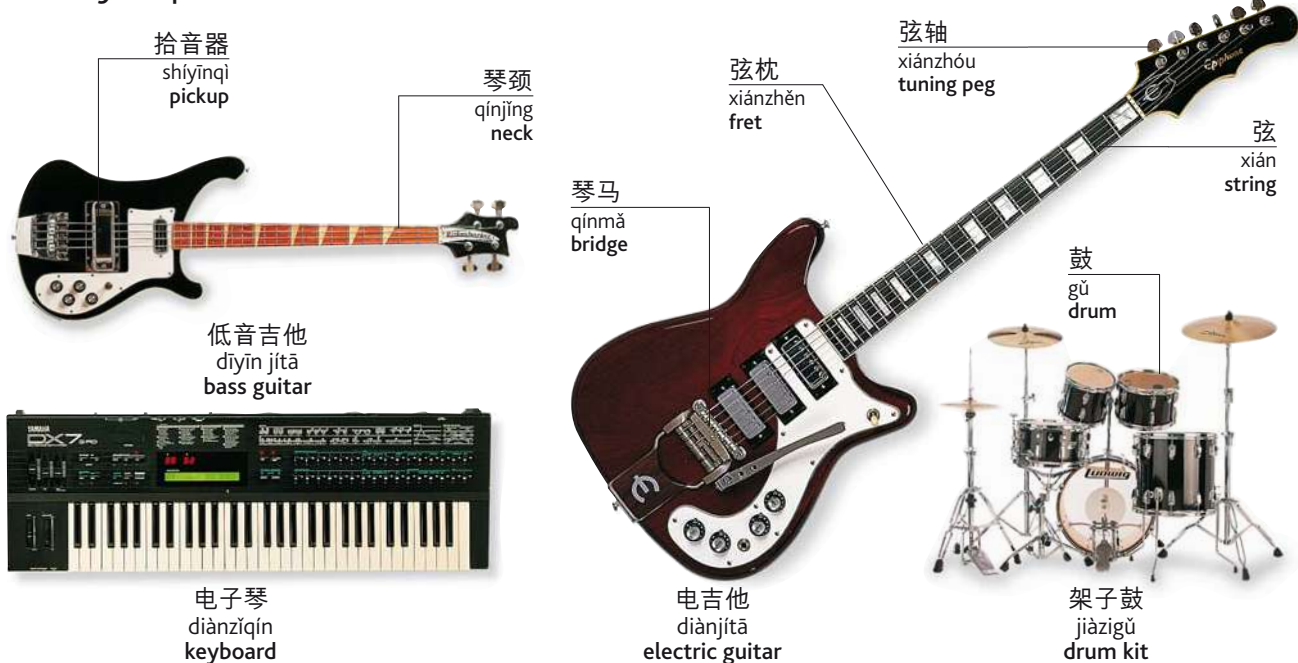

拾音器  
shíyīnqì  
pickup

琴颈  
qínjǐng  
neck

弦枕  
xiánzhěn  
fret

弦轴  
xiánzhóu  
tuning peg

弦  
xián  
string

低音吉他  
dīyīn jítā  
bass guitar

琴马  
qínmǎ  
bridge

鼓  
gǔ  
drum

电子琴  
diànzǐqín  
keyboard

电吉他  
diànjítā  
electric guitar

架子鼓  
jiàzǐgǔ  
drum kit

# 音乐风格 yīnyuè fēnggé • musical styles



爵士乐 juéshīyuè | jazz



蓝调音乐 lándiào yīnyuè | blues



朋克音乐 péngkè yīnyuè | punk



民间音乐 mínjiān yīnyuè | folk music



流行音乐 liúxíng yīnyuè | pop



舞曲 wǔqǔ | dance



说唱音乐 shuōchàng yīnyuè | rap



重金属摇滚 zhòngjīnshǔyáoqǔn  
heavy metal



古典音乐 gǔdiǎn yīnyuè  
classical music

## 词汇 cíhuì • vocabulary

歌曲  
gēqǔ  
song

歌词  
gēcí  
lyrics

旋律  
xuánlǜ  
melody

节拍  
jiépāi  
beat

雷盖音乐  
léigài yīnyuè  
reggae

乡村音乐  
xiāngcūn yīnyuè  
country

聚光灯  
jùguāngdēng  
spotlight



# 观光 guānguāng • sightseeing

游客  
yóukè  
tourist



游览胜地 yóulǎn shèngdì | tourist attraction

旅行路线  
lǚxíng lùxiàn  
itinerary

敞篷  
chǎngpéng  
open-top



观光巴士 guānguāngbāshì | tour bus

导游  
dǎoyóu  
tour guide



团体旅游  
tuántǐlǚyóu  
guided tour

小雕像  
xiǎodiāoxiàng  
statuette



纪念品  
jìniànpǐn  
souvenirs

## 词汇 cíhuì • vocabulary

开门  
kāimén  
open

旅行指南  
lǚxíngzhǐnán  
guide book

便携式摄像机  
biànxìeshì shèxiàngjī  
camcorder

左  
zuǒ  
left

...在哪里?  
...zàinǎlǐ?  
Where is...?

关门  
guānmén  
closed

胶片  
jiāopiàn  
film

照相机  
zhàoxiàngjī  
camera

右  
yòu  
right

我迷路了。  
wǒ mílùle.  
I'm lost.

入场费  
rùchǎngfèi  
entrance fee

电池  
diànchí  
batteries

(行路的)指引  
(xínglùde) zhǐyǐn  
directions

直行  
zhíháng  
straight on

你能告诉我到...的路吗?  
nǐ néng gào sù wǒ dào...delù ma?  
Can you tell me the way to...?

名胜 míngshèng • attractions

绘画  
huìhuà  
painting



艺术馆  
yìshùguǎn  
art gallery

展品  
zhǎnpǐn  
exhibit

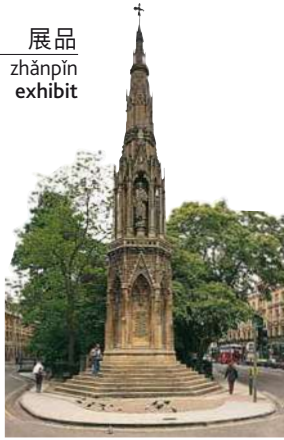

纪念碑  
jìniànbēi  
monument

展览  
zhǎnlǎn  
exhibition



博物馆  
bówùguǎn  
museum

古迹  
gǔjī  
famous ruin



历史建筑  
lìshǐ jiànzhù  
historic building



赌场  
dǔchǎng  
casino



庭园  
tíngyuán  
gardens



国家公园  
guójiā gōngyuán  
national park

游览信息 yóulǎnxìnxī • information

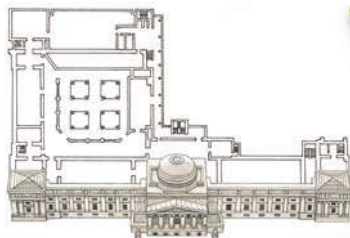

平面图  
píngmiàntú  
floor plan



地图  
dìtú  
map

日程  
rìchéng  
times



时刻表  
shíkèbiǎo  
timetable



旅游问询处  
lǚyóu wènxúnchù  
tourist information



# 户外活动 hùwài huódòng • outdoor activities

小道  
xiǎodào  
footpath

日晷  
rìguǐ  
sundial

咖啡馆  
kāfēiguǎn  
café

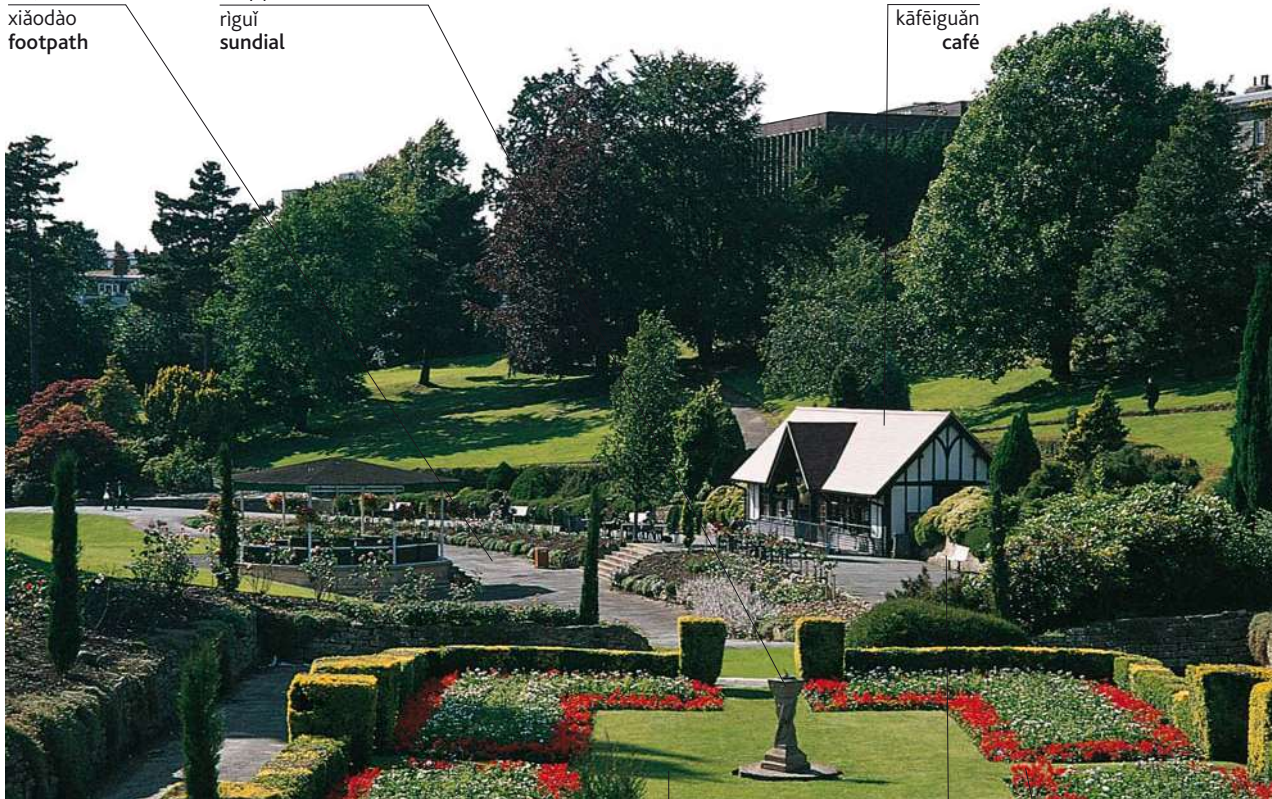

公园 gōngyuán | park

草坪  
cǎopíng  
grass

长椅  
chángyǐ  
bench

法式花园  
fǎshì huāyuán  
formal gardens

过山车  
guòshānchē  
roller coaster



游乐园  
yóulèyuán  
fairground



主题公园  
zhǔtí gōngyuán  
theme park



野生动物园  
yěshēng dòngwùyuán  
safari park



动物园  
dòngwùyuán  
zoo

活动 huódòng • activities



骑自行车  
qízìxíngchē  
cycling



慢跑  
mànpǎo  
jogging



滑板  
huábǎn  
skateboarding



滚轴溜冰  
gǔnzhóu liūbīng  
rollerblading

骑马专用道  
qímǎ zhuānyòngdào  
bridle path



观鸟  
guānniǎo  
bird watching



骑马  
qímǎ  
horse riding



远足  
yuǎnzú  
hiking

食物篮  
shíwùlán  
hamper



野餐  
yěcān  
picnic

游乐场 yóulèchǎng • playground



沙箱  
shāxiāng  
sandpit



儿童戏水池  
értóng xishuǐchí  
paddling pool



秋千  
qiūqiān  
swings



攀登架 pāndēngjià | climbing frame



跷跷板 qiāoqiāobǎn | seesaw



滑梯 huátī | slide



# 海滩 hǎitān • beach

旅馆  
lǚguǎn  
hotel

遮阳伞  
zhēyángsǎn  
beach umbrella

海滩小屋  
hǎitān xiǎowū  
beach hut

沙  
shā  
sand

海浪  
hǎilàng  
wave

海  
hǎi  
sea



海滨游泳袋  
hǎibīn yóuyǒngdài  
beach bag

比基尼泳装  
bǐjīnīyǒngzhuāng  
bikini



晒日光浴 shài rìguāngyù | sunbathe (v)



救生员  
jiùshēngyuán  
lifeguard

救生瞭望塔  
jiùshēng liáowàngtǎ  
lifeguard tower



防风屏  
fángfēngpíng  
windbreak



海滨步道  
hǎibīn bùdào  
promenade



轻便折叠躺椅  
qīngbiàn zhédiétǎngyǐ  
deck chair



太阳镜  
tàiyángjìng  
sunglasses



遮阳帽  
zhēyángmào  
sunhat



防晒油  
fángshàiyou  
suntan lotion



防晒液  
fángshàiè  
sunblock



浮水气球  
fúshuǐqìqiú  
beach ball



游泳圈  
yóuyǒngquān  
rubber ring

游泳衣  
yóuyǒngyī  
swimsuit

铲子  
chǎnzi  
spade

桶  
tǒng  
bucket



沙堡  
shābǎo  
sandcastle

贝壳  
bèiké  
shell



海滩浴巾  
hǎitān yùjīn  
beach towel



# 露营 lùyíng • camping



卫生间  
wèishēngjiān  
toilets

垃圾箱  
lājīxiāng  
waste disposal

浴室  
yùshì  
shower block

接电装置  
jiēdiàn zhuāngzhì  
electric hook-up

防雨罩  
fángyǔzhào  
flysheet

地钉  
dīding  
tent peg

防风绳  
fángfēng shéng  
guy rope

旅行拖车  
lǚxíng tuōchē  
caravan

露营地 lùyíngdì | campsite

## 词汇 cíhuì • vocabulary

露营  
lùyíng  
camp (v)

宿营地  
sùyíngdì  
pitch

野餐长椅  
yěcān chángyǐ  
picnic bench

木炭  
mùtàn  
charcoal

营地管理处  
yíngdì guǎnlǐchù  
site manager's office

支帐篷  
zhīzhàngpéng  
pitch a tent (v)

吊床  
diàochuáng  
hammock

引火物  
yǐnhuǒwù  
firelighter

自由宿营地  
zìyóu sùyíngdì  
pitches available

帐篷杆  
zhàngpénggān  
tent pole

野营车  
yěyíngchē  
camper van

点火  
diǎnhuǒ  
light a fire (v)

满  
mǎn  
full

行军床  
xíngjūn chuáng  
camp bed

拖车  
tuōchē  
trailer

营火  
yínghuǒ  
campfire



支架  
zhījià  
frame

铺地防潮布  
pūdi fāngchǎobù  
ground sheet

背包  
bèibāo  
backpack

保温瓶  
bǎowēnpíng  
vacuum flask

水瓶  
shuǐpíng  
water bottle

帐篷  
zhāngpéng  
tent



驱虫剂  
qūchóngjì  
insect repellent



营地灯  
yíngdìdēng  
torch

蚊帐  
wénzhàng  
mosquito net

保暖内衣  
bǎonuǎn nèiyī  
thermals



徒步靴  
túbùxuē  
walking boots



雨衣  
yǔyī  
waterproofs



睡袋  
shuìdài  
sleeping bag



野营炉  
yěyínglú  
camping stove



烧烤架  
shāokǎojià  
barbecue

睡垫  
shuìdiàn  
sleeping mat



充气床垫 chōngqì chuángdiàn | air mattress



# 家庭娱乐 jiā tíng yú lè • home entertainment



便携式CD播放机  
biànxiéshì CD bōfàngjī  
personal CD player



MD录放机  
MD lùfàngjī  
mini disk recorder



MP3播放机  
MP3 bōfàngjī  
MP3 player



DVD光盘  
DVD guāngpán  
DVD disk

DVD播放机  
DVD bōfàngjī  
DVD player

电唱机  
diànchàngjī  
record player

CD播放机  
CD bōfàngjī  
CD player

收音机  
shōuyīnjī  
radio

功率放大器  
gōnglǜ fàngdàqì  
amplifier

耳机  
ěrjī  
headphones

搁架  
gējià  
stand

音箱  
yīnxiāng  
(loud) speaker

音箱架  
yīnxiāngjià  
speaker stand

高保真音响系统 gāobǎozhēn yīnxiǎng  
xìtǒng | hi-fi system



录像带  
lùxiàngdài  
video tape

录像机  
lùxiàngjī  
video recorder



显示屏  
xiǎnshìpíng  
screen

便携式摄像机  
biànxíeshì shèxiàngjī  
camcorder



接目杯  
jiēmùbēi  
eyecup

卫星电视天线  
wèixīng diànshì tiānxiàn  
satellite dish

宽屏电视  
kuānpíng diànshì  
widescreen television



操纵手柄  
cāozòng shǒubǐng  
controller

视频游戏 shìpín yóuxì | video game

控制台  
kòngzhìtái  
console



快进  
kuàijìn  
fast forward

暂停  
zàntíng  
pause

录制  
lùzhì  
record

音量  
yīnliàng  
volume

倒带  
dǎodài  
rewind

播放  
bōfàng  
play

停止  
tíngzhǐ  
stop



遥控器 yáokòngqì | remote control

## 词汇 cíhuì • vocabulary

激光唱盘  
jīguāng chàngpán  
compact disc

故事片  
gùshìpiàn  
feature film

节目  
jiémù  
programme

收费频道  
shōufèi pǐndào  
pay per view channel

看电视  
kàndiànshì  
watch television (v)

盒式录音带  
héshì lùyīndài  
cassette tape

广告  
guǎnggào  
advertisement

立体声  
lìtǐshēng  
stereo

换频道  
huàn pǐndào  
change channel (v)

关电视  
guāndiànshì  
turn the television off (v)

盒式磁带录音机  
héshì cídàilùyīnjī  
cassette player

数字式  
shùzìshì  
digital

有线电视  
yǒuxiàn diànshì  
cable television

开电视  
kāidiànshì  
turn the television  
on (v)

调收音机  
diàoshōuyīnjī  
tune the radio (v)



# 摄影 shèyǐng • photography

曝光记数器  
bàoguāngjì shùqì  
frame counter

闪光灯  
shǎnguāngdēng  
flash

光圈调节环  
guāngquān tiáojiéhuán  
aperture dial

快门键  
kuàimén jiàn  
shutter release



滤镜  
lǜjìng  
filter



镜头盖  
jìngtóugài  
lens caps

快门速度调节钮  
kuàimén sùdù tiáojiéniǔ  
shutter-speed dial

镜头  
jìngtóu  
lens

单镜头反光照相机 dānjìngtóu fǎnguāngzhàoxiàngjī | SLR camera



三脚架  
sānjiǎojià  
tripod



闪光灯  
shǎnguāngdēng  
flash gun



曝光表  
bàoguāngbiǎo  
lightmeter



变焦镜头  
biànjiāo jìngtóu  
zoom lens

## 相机种类 xiàngjī zhǒnglèi • types of camera



数码相机  
shùmǎ xiàngjī  
digital camera



一次成像全自动相机  
yīcìchéngxiàng quánzìdòng  
xiàngjī  
APS camera



立拍立现相机  
lìpāi lìxiàn xiàngjī  
instant camera



一次性相机  
yīcìxìng xiàngjī  
disposable camera

# 照相 zhàoxiàng • photograph (v)



胶卷  
jiāojiǎn  
film spool



调焦  
tiáojiāo  
focus (v)



冲洗  
chōngxǐ  
develop (v)



底片  
dǐpiān  
negative

胶片  
jiāopiān  
film

全景照  
quánjǐngzhào  
landscape



相片 xiàngpiān | photograph

人像照  
rénxiàngzhào  
portrait



相册  
xiàngcè  
photo album



相框  
xiāngkuàng  
photo frame

# 问题 wèntí • problems



曝光不足  
pùguāng bùzú  
underexposed



曝光过度  
pùguāng guòdù  
overexposed



调焦不准  
tiáojiāo bùzhǔn  
out of focus



红眼  
hóngyǎn  
red eye

# 词汇 cíhuì • vocabulary

取景器  
qǔjǐngqì  
viewfinder

相机盒  
xiàngjīhé  
camera case

曝光  
pùguāng  
exposure

暗室  
ànshì  
darkroom

样片  
yàngpiàn  
print

无光泽  
wúguāngzé  
mat

有光泽  
yǒuguāngzé  
gloss

放大  
fàngdà  
enlargement

请冲洗这个胶卷。  
qǐng chōngxǐ zhège jiāojiǎn.  
I'd like this film processed



# 游戏 yóuxì • games

棋盘  
qípán  
chessboard

黑格  
hēigé  
black

白格  
báigé  
white

后  
hòu  
queen

王  
wáng  
king

兵  
bīng  
pawn

马  
mǎ  
knight

象  
xiàng  
bishop

车  
chē  
rook

方格  
fānggé  
square

国际象棋  
guójìxiàngqí  
chess

字牌  
zìpái  
tile

棋子  
qízǐ  
piece

拼字游戏 pīnzì yóuxì | scrabble

国际跳棋  
guójìtiàiqí  
draughts

筹码  
chóumǎ  
counter

强手棋  
qiángshǒuqí  
monopoly

骰子  
tóuzǐ  
dice

棋盘游戏 qípán yóuxì | board games

西洋双陆棋 xīyáng shuānglùqí | backgammon

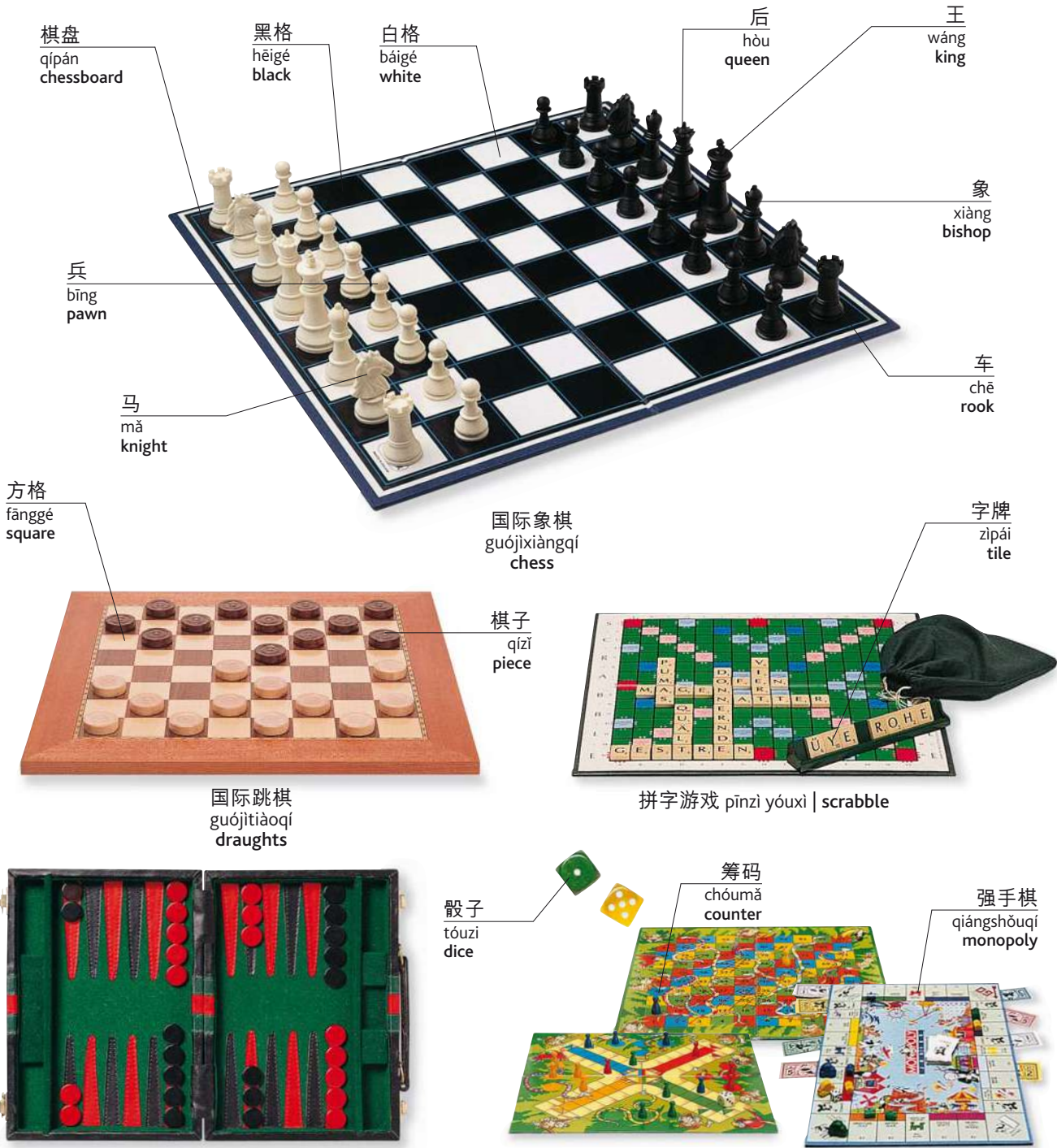



集邮 jíyóu | stamp collecting



拼图 pīntú | jigsaw puzzle



多米诺骨牌 duōmīnuò gǔpái dominoes

靶盘 bǎnpán dartboard

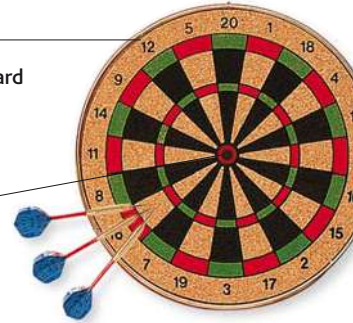

靶心 bǎxīn bullseye

飞镖 fēibiāo | darts

王牌 wángpái joker

J zhei jack

Q kiu queen

K kei king

A ei ace

纸牌 zhǐpái | cards



方块 fāngkuài diamond

黑桃 hēitáo spade

红心 hóngxīn heart

梅花 méihuā club



洗牌 xǐpái | shuffle (v)



发牌 fāpái | deal (v)

词汇 cíhuì • vocabulary

走棋 zǒuqí move

赢 yíng win (v)

输家 shūjiā loser

点 diǎn point

桥牌 qiáopái bridge

掷骰子 zhītóuzi. Roll the dice.

玩 wán play (v)

赢家 yíngjiā winner

游戏 yóuxì game

得分 défēn score

一副牌 yīfùpái pack of cards

该谁了? gāishuile? Whose turn is it?

玩家 wánjiā player

输 shū lose (v)

赌注 dǔzhù bet

扑克牌 pūkèpái poker

同花 tonghuā suit

该你了。gāinǐle. It's your move.



# 工艺美术 1 gōngyīměishù yī • arts and crafts 1



(用颜料等)绘画 (yòng yánliào děng) huìhuà | painting

## 颜料 yánliào • paints



油画颜料 yóuhuà yánliào  
oil paints



水彩画颜料 shuǐcǎi huàyánliào  
watercolour paint



彩色蜡笔 cǎisèlàbǐ  
pastels



丙烯颜料 bǐngxī yánliào  
acrylic paint



广告颜料 guǎnggào yánliào | poster paint

## 颜色 yánsè • colours



红色 hóngsè | red



蓝色 lánsè | blue



黄色 huángsè  
yellow



绿色 lǜsè | green



橘色 júse | orange



紫色 zǐsè | purple



白色 báisè | white



黑色 hēisè | black



灰色 huīsè | grey



粉红色 fēnhóngsè  
pink



褐色 hèsè | brown



靛青色 diànqīngsè  
indigo

其他工艺 qítā gōngyì • other crafts

素描簿 sùmiáobù sketch pad  
素描 sùmiáo | drawing  
草图 cǎotú sketch  
油墨 yóumò ink  
铅笔 qiānbǐ pencil  
炭笔 tànbǐ charcoal

印刷 yìnshuā | printing

版画 bǎnhuà | engraving

雕刻 diāokè sculpting  
石头 shítou stone  
木槌 mùchuí mallet  
凿子 záozi chisel  
木头 mùtóu wood  
木工 mùgōng woodworking

陶艺 táoyì | pottery  
刮刀 guādāo modelling tool  
陶工转盘 yáogōng zhuànpán potter's wheel  
黏土 niántǔ clay

拼贴 pīntiē | collage  
胶 jiāo glue  
纸板 zhǐbǎn cardboard

珠宝制作 zhūbǎo zhìzuò jewellery making

纸板制型 zhǐbǎnzhìxíng papier-mâché

折纸 zhézhǐ origami

模型制作 móxíng zhìzuò model making



# 工艺美术 2 gōngyīměishùè • arts and crafts 2



缝纫机 féngrènjī | sewing machine



剪刀 jiǎndāo scissors



纸样 zhǐyàng pattern



针线筐 zhēnxiānkuāng | sewing basket



卷尺 juǎnchǐ tape measure



布料 bùliào material

针垫 zhēndiàn pincushion

大头针 dàtóuzhēn pin



线轴 xiànzhóu bobbin



线 xiàn thread



领钩环 lǐnggōuhuán eye



领钩 lǐnggōu hook



顶针 dǐngzhēn thimble



划粉 huáfěn tailor's chalk



人体模型 réntǐ móxíng tailor's dummy



穿针  
chuānzhēn  
thread (v)



缝  
féng  
sew (v)

针脚  
zhēnjiǎo  
stitch



织补  
zhībǔ  
darn (v)



粗缝  
cūféng  
tack (v)

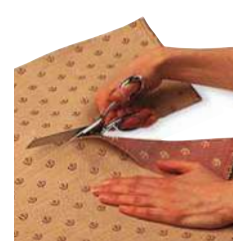

剪裁  
jiǎncái  
cut (v)



绒绣  
róngxiù  
needlepoint



刺绣  
cìxiù  
embroidery

钩针  
gōuzhēn  
crochet hook



钩织  
gōuzhī  
crochet



流苏花边  
liúsū huābiān  
macramé



拼缝  
pīnféng  
patchwork



绗缝  
hángféng  
quilting



织边  
zhībiān  
lace-making

线轴  
xiànzhóu  
lace bobbin

织布机  
zhībùjī  
loom



纺织  
fǎngzhī  
weaving

词汇 cíhuì • vocabulary

拆开  
chāikāi  
unpick (v)

尼龙  
nílóng  
nylon

布匹  
bùpǐ  
fabric

丝绸  
sīchóu  
silk

棉布  
miánbù  
cotton

设计师  
shèjìshī  
designer

亚麻布  
yàmábù  
linen

时尚  
shíshàng  
fashion

聚酯  
jùzhǐ  
polyester

拉链  
lāliàn  
zip



编织针  
biānzhīzhēn  
knitting needle

编织 biānzhī | knitting



毛线  
máoxiàn  
wool

线束 xiànsù | skein









环境 huánjìng  
environment





# 宇宙空间 yǔzhòukōngjiān • space

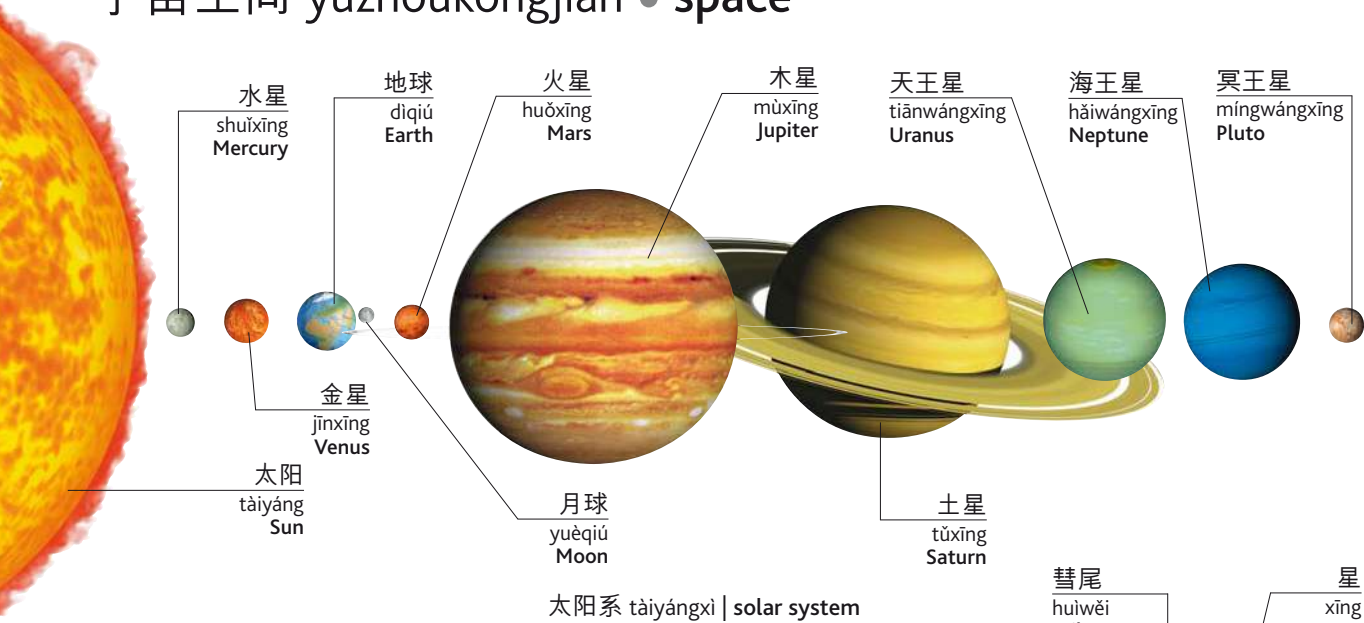

星系 xīngxì galaxy



星云 xīngyún nebula



小行星 xiǎoxīngxīng asteroid



彗星 huìxīng comet

## 词汇 cíhuì • vocabulary

宇宙 yǔzhòu universe

黑洞 hēidòng black hole

满月 mǎnyuè full moon

轨道 guǐdào orbit

行星 xíngxīng planet

新月 xīnyuè new moon

重力 zhònglì gravity

流星 liúxīng meteor

弦月 xiányuè crescent moon



(日、月)食 (rì, yuè) shí | eclipse

# 太空探索 tàikōngfú • space exploration

航天飞机  
hángtiān fēijī  
space shuttle

推进器  
tuījìnqì  
booster



发射  
fāshè  
launch

太空服  
tàikōngfú  
space suit



宇航员 yǔhángyuán  
astronaut

发射架  
fāshèjià  
launch pad



人造卫星  
rénzàowèixīng  
satellite

助推器  
zhùtuīqì  
thruster

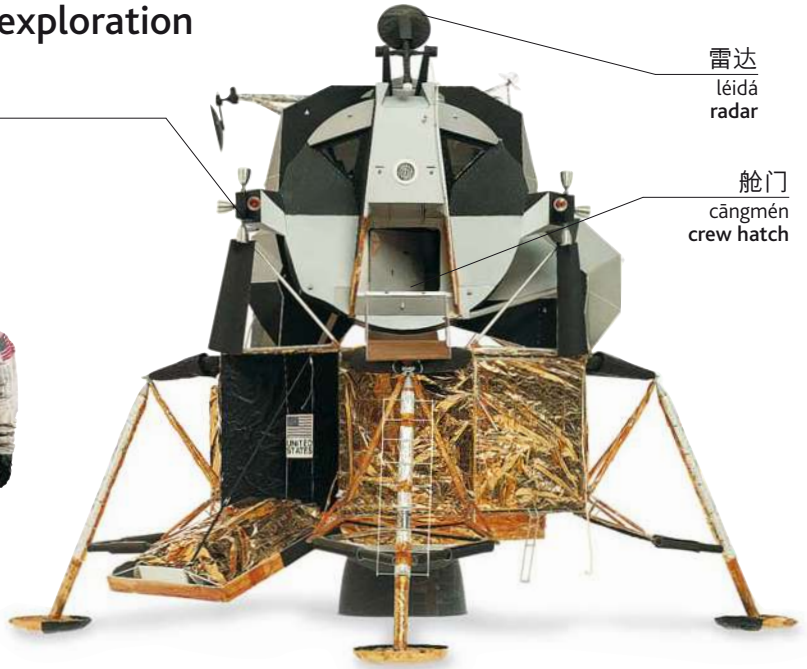

登月舱 dēngyuècāng | lunar module

雷达  
léidá  
radar

舱门  
cāngmén  
crew hatch



空间站  
kōngjiān zhàn  
space station

# 天文学 tiānwénxué • astronomy



星座  
xīngzuò  
constellation



双筒望远镜  
shuāngtǒng wàngyuǎnjìng  
binoculars



天文望远镜  
tiānwén  
wàngyuǎnjìng  
telescope

三脚架  
sānjiǎojià  
tripod



# 地球 dìqiú • Earth

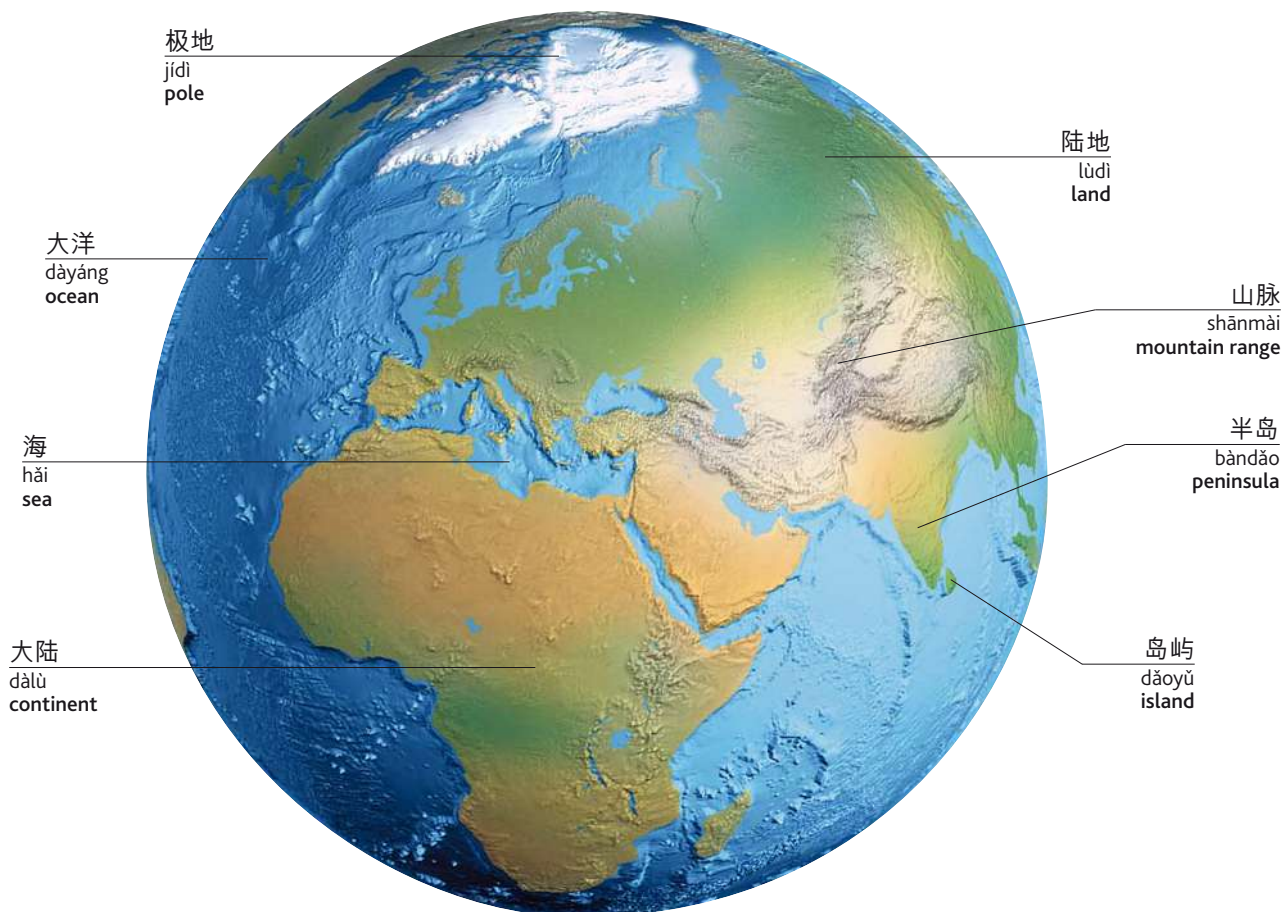

行星 xíngxīng | planet

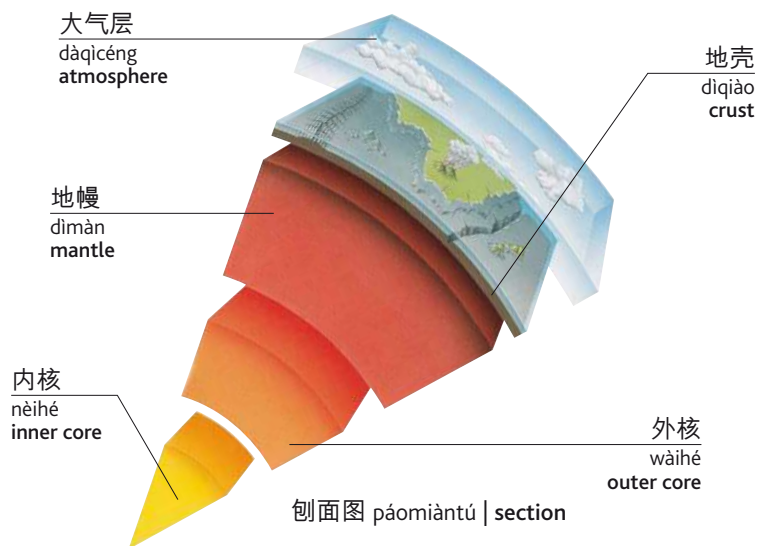

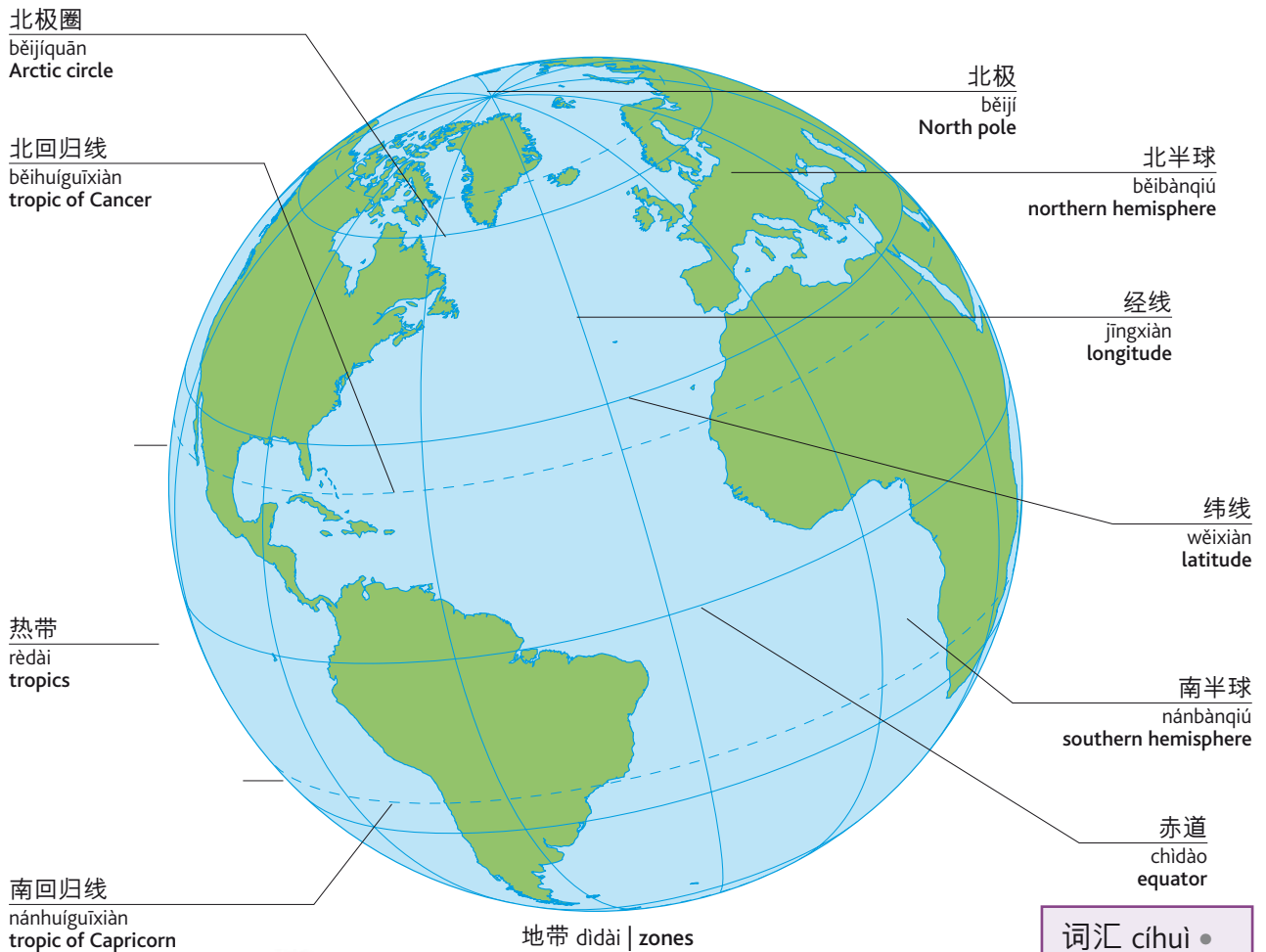

词汇 cíhuì •  
vocabulary

地震  
dìzhèn  
earthquake

板块  
bǎnkuài  
plate

喷发  
pēnfā  
erupt (v)

震动  
zhèndòng  
tremor

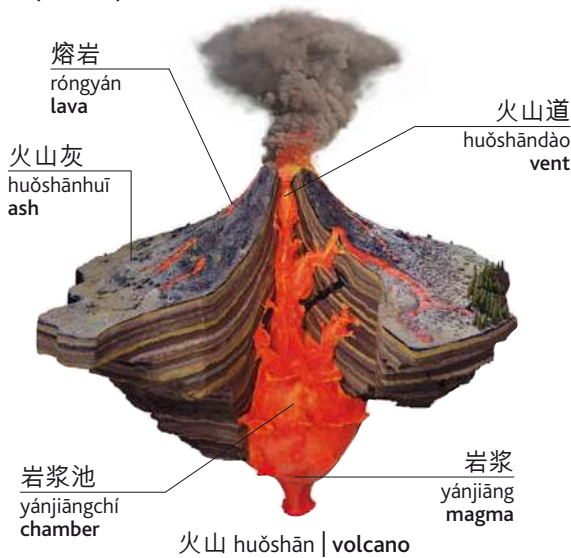

火山口 huǒshānkǒu | crater



# 地貌 dìmào • landscape

山  
shān  
mountain

山坡  
shānpō  
slope

河岸  
hé'àn  
bank

河流  
héliú  
river

急流  
jiliú  
rapids

岩石  
yánshí  
rocks

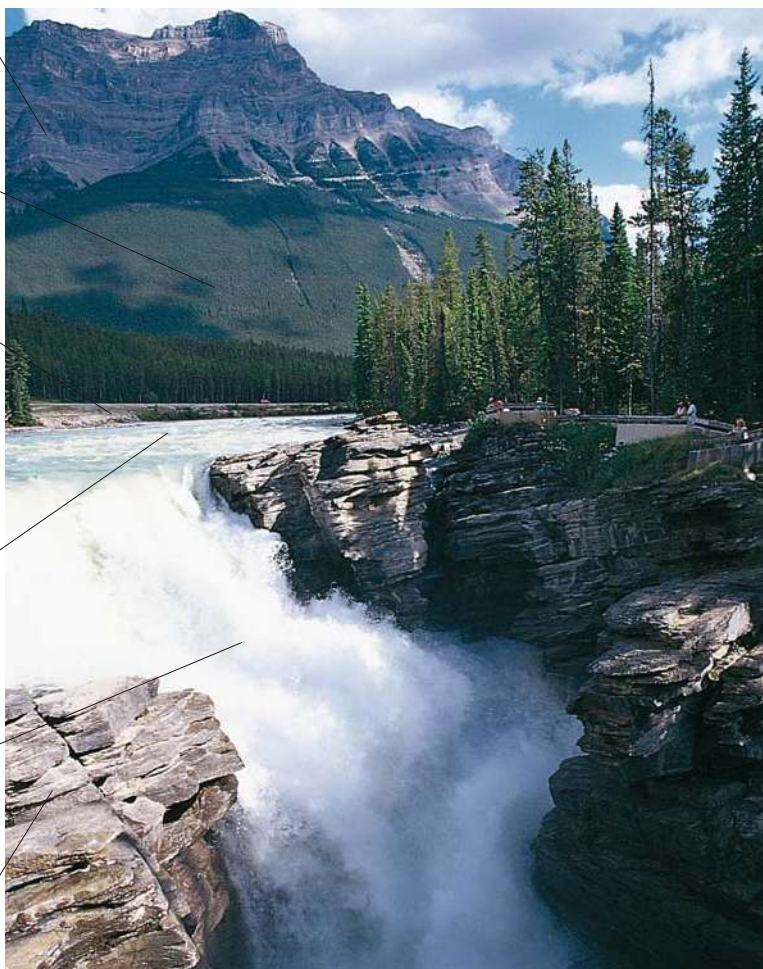

冰河  
bīnghé  
glacier



山谷 shāngǔ | valley



丘陵  
qiūlíng  
hill



高原  
gāoyuán  
plateau



峡谷  
xiágǔ  
gorge

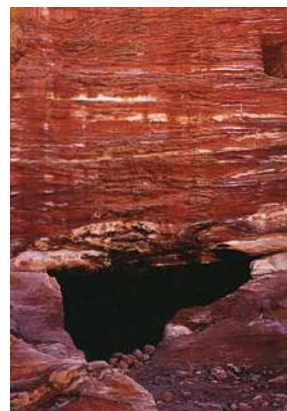

岩洞  
yándòng  
cave





平原 píngyuán | plain



沙漠 shāmò | desert



森林 sēnlín | forest



树林 shùlín | wood



雨林  
yǔlín  
rainforest



沼泽  
zhāozé  
swamp



草场  
cǎochǎng  
meadow



草原  
cǎoyuán  
grassland



瀑布  
pùbù  
waterfall



溪流  
xīliú  
stream



湖  
hú  
lake



间歇喷泉  
jiànxiē pēnquán  
geyser



海岸  
hǎi'àn  
coast



悬崖  
xuányá  
cliff



珊瑚礁  
shānhújiāo  
coral reef



河口  
hékǒu  
estuary



# 天气 tiānqì • weather

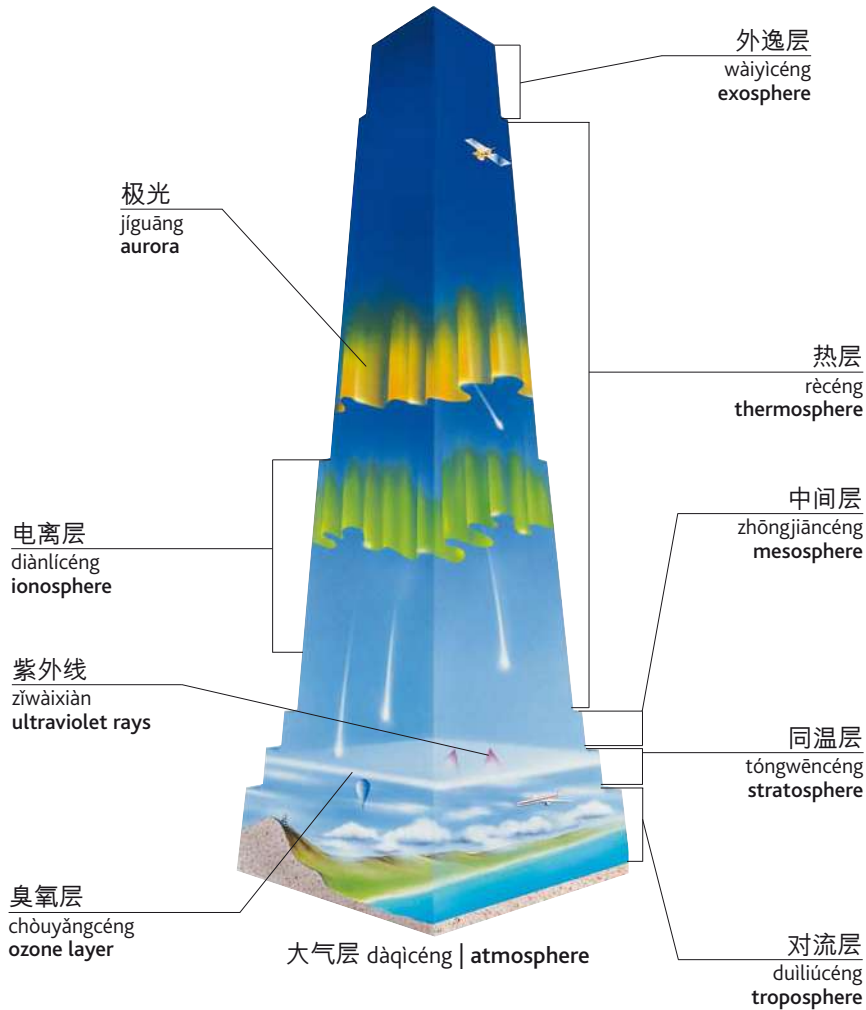

阳光 yángguāng | sunshine



风 fēng | wind

## 词汇 cíhuì • vocabulary

雨夹雪  
yǔjiāxuě  
sleet

阵雨  
zhènyǔ  
shower

热  
rè  
hot

干燥  
gānzào  
dry

多风  
duōfēng  
windy

我热/冷。  
wǒ rè/lěng.  
I'm hot/cold.

冰雹  
bīngbào  
hail

阳光明媚  
yángguāng míngmèi  
sunny

冷  
lěng  
cold

潮  
cháo  
wet

狂风  
kuángfēng  
gale

正在下雨。  
zhèngzài xiàyǔ.  
It's raining.

雷  
léi  
thunder

多云  
duōyún  
cloudy

温暖  
wēnuǎn  
warm

湿润  
shīrùn  
humid

温度  
wēndù  
temperature

度...  
dù...  
It's ... degrees.



云 yún | cloud



雨 yǔ | rain



闪电  
shǎndiàn  
lightning

暴风雨 bàofēngyǔ | storm



雾 wù | mist



雾 wù | fog



彩虹 cǎihóng | rainbow



雪 xuě | snow



霜 shuāng | frost



冰 bīng | ice



冰柱  
bīngzhù  
icicle

结冰 jiébīng | freeze



飓风 jùfēng | hurricane



龙卷风 lóngjuǎnfēng  
tornado



季风 jìfēng | monsoon



洪水 hóngshuǐ | flood



# 岩石 yánshí • rocks

## 火成岩 huǒchéngyán • igneous



花岗岩  
huāgāngyán  
granite



黑曜岩  
hēiyàoyán  
obsidian



玄武岩  
xuánwǔyán  
basalt



浮石  
fúshí  
pumice

## 沉积岩 chénjīyán • sedimentary



砂岩  
shāyán  
sandstone



石灰岩  
shíhuīyán  
limestone



白垩  
bái'è  
chalk



燧石  
suǐshí  
flint



砾岩  
lìyán  
conglomerate



煤  
méi  
coal

## 变质岩 biànzhìyán • metamorphic



板岩  
bǎnyán  
slate



页岩  
yèyán  
schist



片麻岩  
piànmáyán  
gneiss



大理石  
dàlǐshí  
marble

## 宝石 bǎoshí • gems

红宝石  
hóngbǎoshí  
ruby



海蓝宝石  
hǎilánbǎoshí  
aquamarine



紫水晶  
zǐshuǐjīng  
amethyst



钻石  
zuànshí  
diamond



玉石  
yùshí  
jade



黑玉  
hēiyù  
jet



绿宝石  
lǜbǎoshí  
emerald



蛋白石  
dànbáishí  
opal



蓝宝石  
lánbǎoshí  
sapphire



月长石  
yuèzhǎngshí  
moonstone



石榴石  
shíliúshí  
garnet



黄玉  
huángyù  
topaz



电气石  
diànqìshí  
tourmaline



## 矿物 kuàngwù • minerals



石英  
shíyīng  
quartz



云母  
yúnmǔ  
mica



硫磺  
liúhuáng  
sulphur



赤铁矿  
chìtiěkuàng  
hematite



方解石  
fāngjiěshí  
calcite



孔雀石  
kǒngquèshí  
malachite



绿松石  
lǜsōngshí  
turquoise



缟玛瑙  
gǎomǎnǎo  
onyx

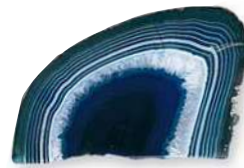

玛瑙  
mǎnǎo  
agate



石墨  
shímò  
graphite

## 金属 jīnshǔ • metals



金属  
jīnshǔ  
gold



银  
yín  
silver



铂  
bó  
platinum



镍  
niè  
nickel



铁  
tiě  
iron



铜  
tóng  
copper



锡  
xī  
tin



铝  
lǚ  
aluminium



汞  
gǒng  
mercury



锌  
xīn  
zinc



# 动物 1 dòngwùyī • animals 1

## 哺乳动物 bǔrǔ dòngwù • mammals



兔子  
tùzǐ  
rabbit



仓鼠  
cāngshǔ  
hamster

腮须  
sāixū  
whiskers



小家鼠  
xiǎojiāshǔ  
mouse

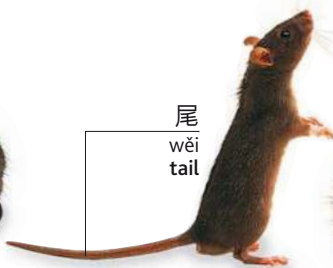

尾  
wěi  
tail

老鼠  
lǎoshǔ  
rat



刺猬  
cìwēi  
hedgehog



松鼠  
sōngshǔ  
squirrel



蝙蝠  
biānfú  
bat



浣熊  
huànxióng  
raccoon



狐狸  
húlǐ  
fox



狼  
láng  
wolf

小狗  
xiǎogǒu  
puppy



狗  
gǒu  
dog

小猫  
xiǎomāo  
kitten



猫  
māo  
cat

小海豹  
xiǎohǎibào  
pup



水獭  
shuǐtǎ  
otter



海豹  
hǎibào  
seal



海狮  
hǎishī  
sea lion

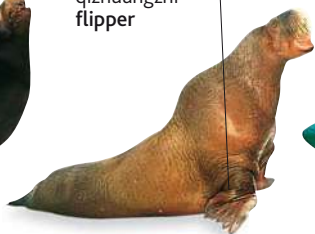

鳍状肢  
qízuàngzhī  
flipper

海象  
hǎixiàng  
walrus

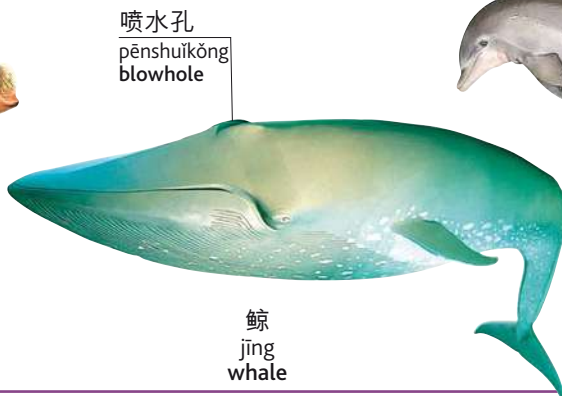

喷水孔  
pēnshuǐkǒng  
blowhole

鲸  
jīng  
whale



海豚  
hǎitún  
dolphin



鹿  
lù  
deer

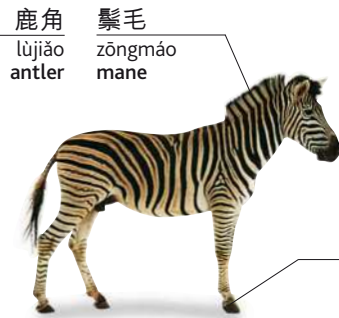

斑马  
bānmǎ  
zebra



长颈鹿  
chángjǐnglù  
giraffe



骆驼  
luòtuó  
camel



河马  
hémǎ  
hippopotamus

象鼻  
xiàngbí  
trunk

长牙  
chángyá  
tusk

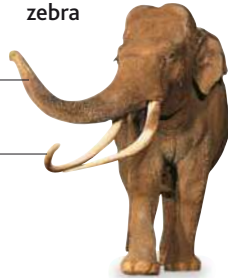

象  
xiàng  
elephant

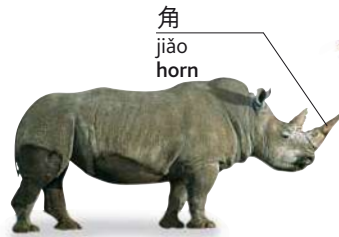

角  
jiǎo  
horn

犀牛  
xīniú  
rhinoceros



虎  
hǔ  
tiger



鬃毛  
zōngmáo  
mane

狮子  
shīzi  
lion



猴子  
hóuzi  
monkey



大猩猩  
dàxīngxīng  
gorilla



树袋熊  
shùdài xióng  
koala

育儿袋  
yù'ěrdài  
pouch

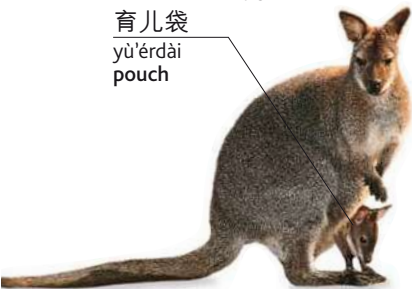

袋鼠  
dàishǔ  
kangaroo



熊  
xióng  
bear

爪  
zhǎo  
claw



北极熊  
běijí xióng  
polar bear

熊猫  
xióngmāo  
panda





# 动物 2 dòngwùèr • animals 2

## 鸟 niǎo • birds



金丝雀  
jīnsīquè  
canary



麻雀  
máquè  
sparrow



蜂鸟  
fēngniǎo  
hummingbird



燕子  
yànzi  
swallow



乌鸦  
wūyā  
crow



鸽子  
gēzi  
pigeon



啄木鸟  
zhuómùniǎo  
woodpecker



隼  
sǔn  
falcon



猫头鹰  
māotóuyīng  
owl



海鸥  
hǎi'ōu  
gull



鹰  
yīng  
eagle



鹈鹕  
tíhú  
pelican



火烈鸟  
huǒlièniǎo  
flamingo



鹤  
guàn  
stork



鹤  
hè  
crane



企鹅  
qīe  
penguin



鸵鸟  
tuóniǎo  
ostrich



鹅 é | goose

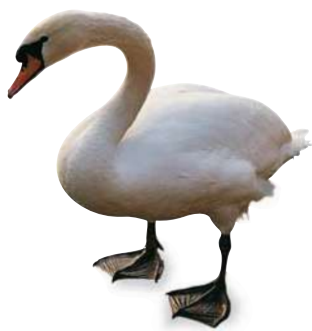

天鹅 tiān é swan



孔雀 kǒng què peacock



雉 zhì pheasant



火鸡 huǒ jī turkey



美冠鹦鹉 měi guān yīng wǔ cockatoo

喙 huì bill



羽毛 yǔ máo feather

翅膀 chì bǎng wing

爪 zhǎo claw

鹦鹉 yīng wǔ parrot

爬行动物 pá xíng dòng wù • reptiles

鳞 lín scales



短吻鳄 duǎn wěn è alligator



蜥蜴 xī yì lizard



鬣蜥 liè xī iguana



海龟 hǎi guī turtle



龟壳 guī ké shell

龟 guī tortoise

蛇 shé snake



吻 wěn snout



鳄鱼 è yú crocodile



# 动物 3 dòngwùsān • animals 3

## 两栖动物 liǎngqī dòngwù • amphibians



蛙  
wā  
frog



蟾蜍  
chánchú  
toad



蝌蚪  
kēdǒu  
tadpole



蝾螈  
róngyuán  
salamander

## 鱼类 yúlei • fish



鳗鱼  
mányú  
eel

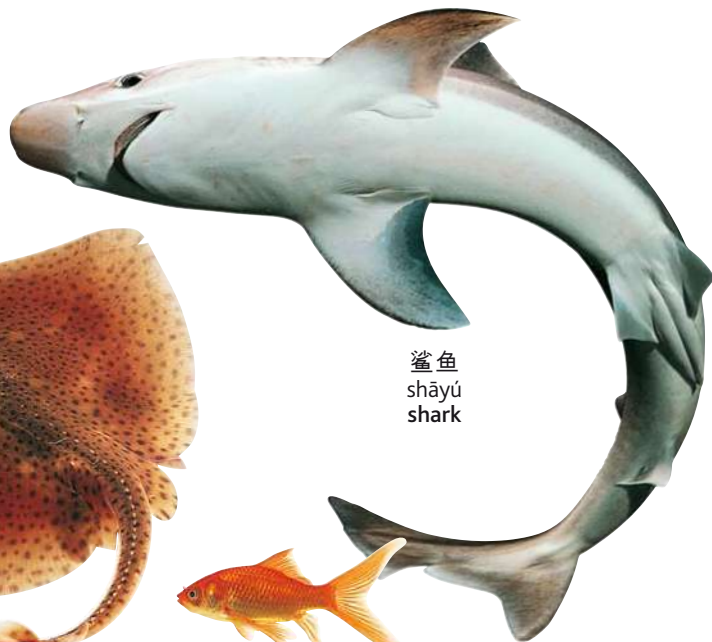

鲨鱼  
shāyú  
shark



海马  
hǎimǎ  
sea horse



鳐鱼  
yáoyú  
skate

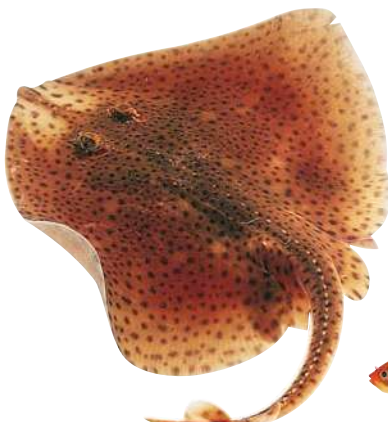

魟鱼  
hóngyú  
ray



金鱼  
jīnyú  
goldfish



剑鱼 jiànyú | swordfish

背鳍  
bèiqí  
dorsal fin

胸鳍  
xiōngqí  
pectoral fin

尾  
wěi  
tail

鳃  
sāi  
gill

鳞  
lín  
scale

鲤鱼 lǐyú | koi carp

无脊椎动物 wújǐzhūi dòngwù • invertebrates



蚂蚁  
mǎyǐ  
ant



白蚁  
báiyǐ  
termite



蜜蜂  
mífēng  
bee



黄蜂  
huángfēng  
wasp



甲壳虫  
jiǎqiào chóng  
beetle



蟑螂  
zhāngláng  
cockroach



蛾  
é  
moth



蝴蝶  
húdié  
butterfly

触角  
chùjiǎo  
antenna



茧  
jiǎn  
cocoon



毛虫  
máochóng  
caterpillar



蟋蟀 xīshuài | cricket



蚱蜢  
zhàměng  
grasshopper



螳螂  
tángláng  
praying mantis



蜚针  
zhēzhēn  
sting

蝎子  
xiēzi  
scorpion



蜈蚣  
wúgōng  
centipede



蜻蜓  
qīngtīng  
dragonfly



蒼蝇  
cāngyīng  
fly



蚊子  
wénzi  
mosquito



瓢虫  
piāochóng  
ladybird



蜘蛛  
zhīzhū  
spider



蛞蝓  
kuòyú  
slug



蜗牛  
wōniú  
snail



蚯蚓 qiūyǐn | worm



海星  
hǎixīng  
starfish



贻贝  
yíbei  
mussel



螃蟹 pángxiè | crab



龙虾 lóngxiā | lobster



章鱼 zhāngyú | octopus



鱿鱼 yóuyú | squid



水母 shuǐmǔ | jellyfish



# 植物 zhíwù • plants

## 树 shù • tree

树枝  
shùzhī  
branch

根  
gēn  
root

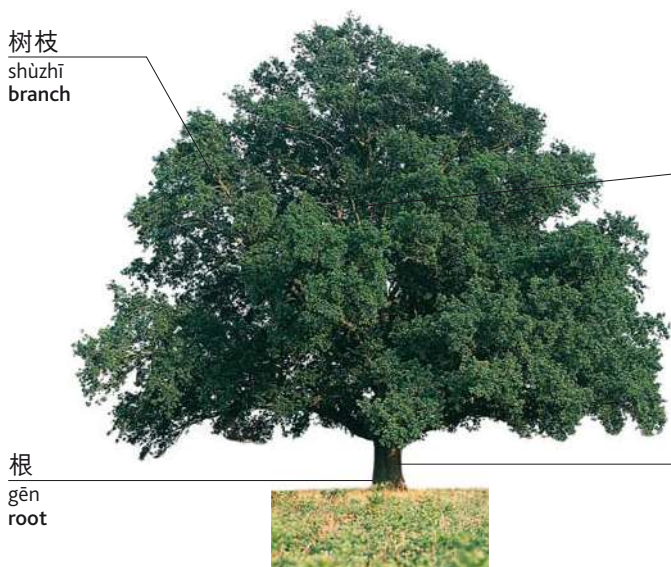

橡树 xiàngshù | oak



落叶松  
luòyèsōng  
larch



山毛榉  
shānmáojǔ  
beech



桦树  
huàshù  
birch



松树  
sōngshù  
pine



雪松  
xuěsōng  
cedar



枫树  
fēngshù  
maple



榆树  
yúshù  
elm



椴树  
duànshù  
lime



冬青树  
dōngqīngshù  
holly



浆果  
jiāngguǒ  
berry

棕榈树  
zōnglǔshù  
palm



叶  
yè  
leaf

细枝  
xìzhī  
twig

树皮  
shùpí  
bark

树干  
shùgān  
trunk



白杨  
báiyáng  
poplar



桉树  
ānshù  
eucalyptus



柳树  
liǔshù  
willow



显花植物 xiǎnhuā zhíwù • flowering plant

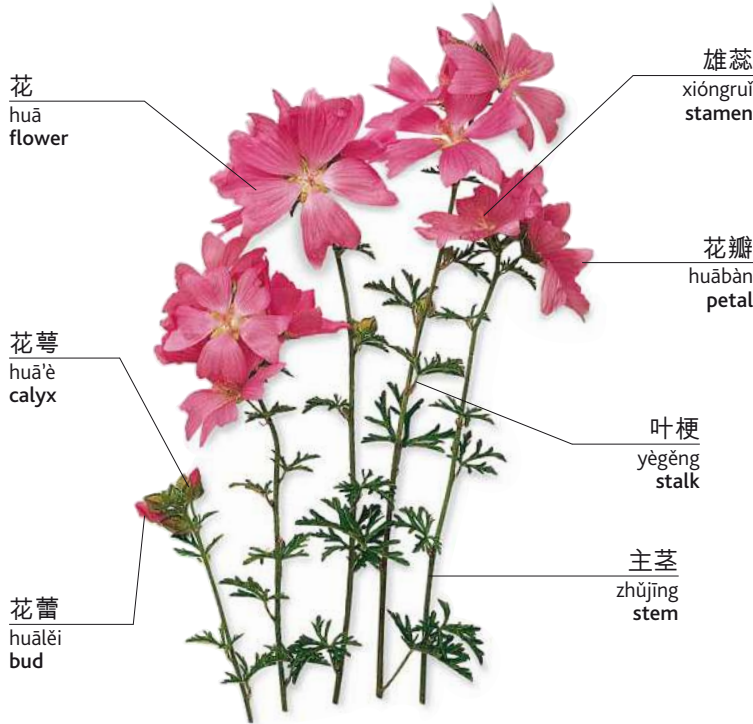

毛茛 máogèn  
buttercup



雏菊 chújú  
daisy



蓟 jì  
thistle



蒲公英 púgōngyīng  
dandelion



石南花 shínánhuā  
heather



罂粟 yīngsù  
poppy



毛地黄 máodihuáng  
foxglove



忍冬 rěndōng  
honeysuckle



向日葵 xiàngrikuí  
sunflower



苜蓿 mùxu  
clover



野风信子 yěfēngxìnzi  
bluebells



樱草 yīngcǎo  
primrose



羽扇豆 yǔshàn dòu  
lupins



荨麻 qiánmá  
nettle



# 城镇 chéngzhèn • town





建筑物 jiànzhùwù • buildings



市政厅  
shìzhèngtīng  
town hall



图书馆  
túshūguǎn  
library



电影院  
diànyǐngyuàn  
cinema



剧院  
jùyuàn  
theatre



大学  
dàxué  
university



摩天大楼  
mótiān dàlóu  
skyscraper



学校  
xuéxiào  
school

区域 qūyù • areas



工业区  
gōngyèqū  
industrial estate



市区  
shìqū  
city



郊区  
jiāoqū  
suburb



村庄  
cūnzhuāng  
village

词汇 cíhuì • vocabulary

步行区  
bùxíngqū  
pedestrian zone

小街  
xiǎojiē  
side street

检修井  
jiǎnxiūjǐng  
manhole

排水沟  
páishuǐgōu  
gutter

教堂  
jiàotáng  
church

林阴道  
lín yīng dào  
avenue

广场  
guǎngchǎng  
square

公共汽车站  
gōnggòngqìchē zhàn  
bus stop

工厂  
gōngchǎng  
factory

下水道  
xiàshuǐdào  
drain



# 建筑 jiànzhù • architecture

## 建筑与结构 jiànzhù yǔ jiégòu • buildings and structures



摩天大楼  
mótiān dàlóu  
skyscraper



城堡  
chéngbǎo  
castle



教堂  
jiàotáng  
church

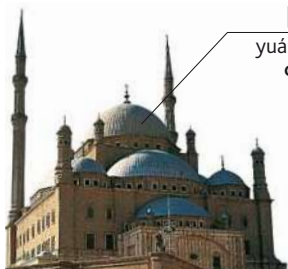

清真寺  
qīngzhēnsī  
mosque



寺庙  
sīmào  
temple



犹太教会堂  
yóutàijiào huìtáng  
synagogue

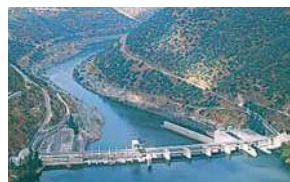

水坝  
shuǐbà  
dam



桥梁  
qiáoliáng  
bridge

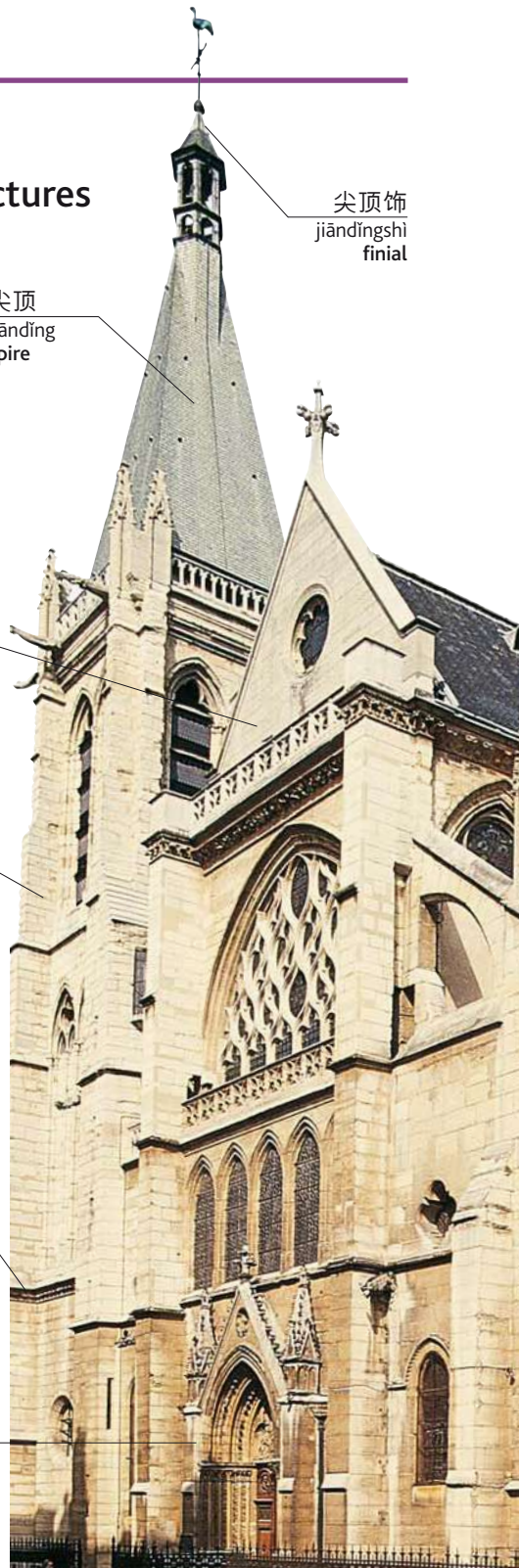

尖顶饰  
jiāndǐngshì  
finial

角楼 尖顶  
jiǎolóu jiāndǐng  
turret spire

壕沟  
háogōu  
moat

三角墙  
sānjiǎoqiáng  
gable

圆顶  
yuándǐng  
dome

塔  
tǎ  
tower

拱型圆顶  
gǒngxíng yuándǐng  
vault

檐口  
yánkǒu  
cornice

柱  
zhù  
pillar

大教堂 dàjiàotáng | cathedral



# 建筑风格 jiànzhù fēnggé • styles



哥特式 gētèshì | gothic

柱顶楣梁  
zhùdǐng méiliáng  
architrave



文艺复兴时期风格  
wényifùxīng shíqī fēnggé  
Renaissance



巴洛克式  
bālǜokèshì  
baroque

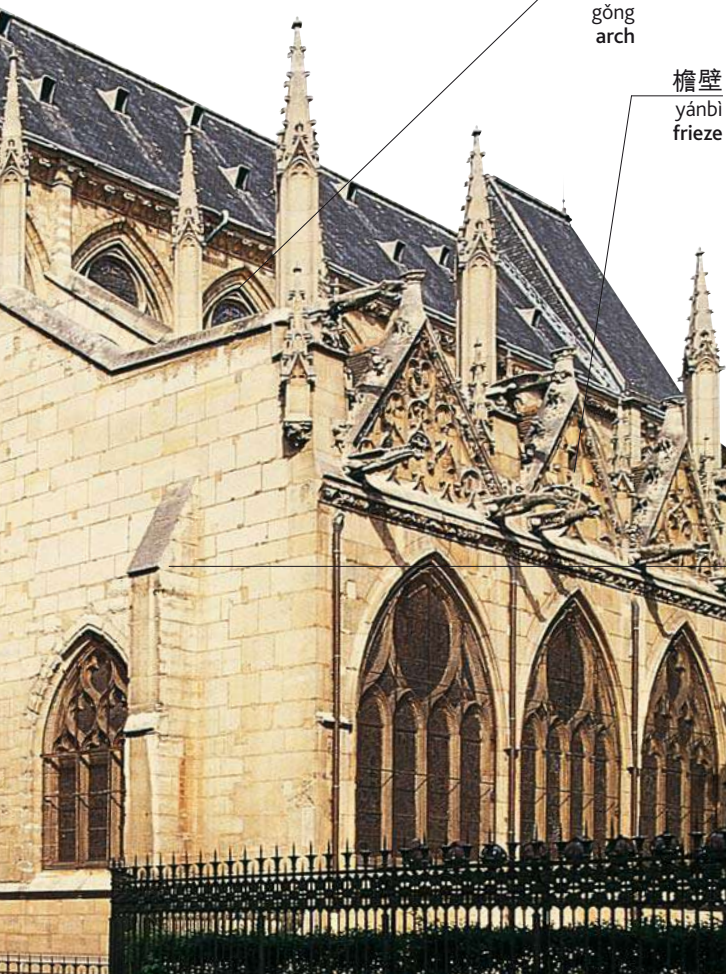

拱  
gǒng  
arch

檐壁  
yánbì  
frieze

圣坛  
shèngtán  
choir

三角楣  
sānjiǎoméi  
pediment

扶墙  
fúqiáng  
buttress



洛可可式  
luòkěkèshì  
rococo



新古典主义风格  
xīn gǔdiǎnzhūyì fēnggé  
neoclassical



新艺术风格  
xīn yìshù fēnggé  
art nouveau



装饰艺术风格  
zhuāngshìyìshù fēnggé  
art deco



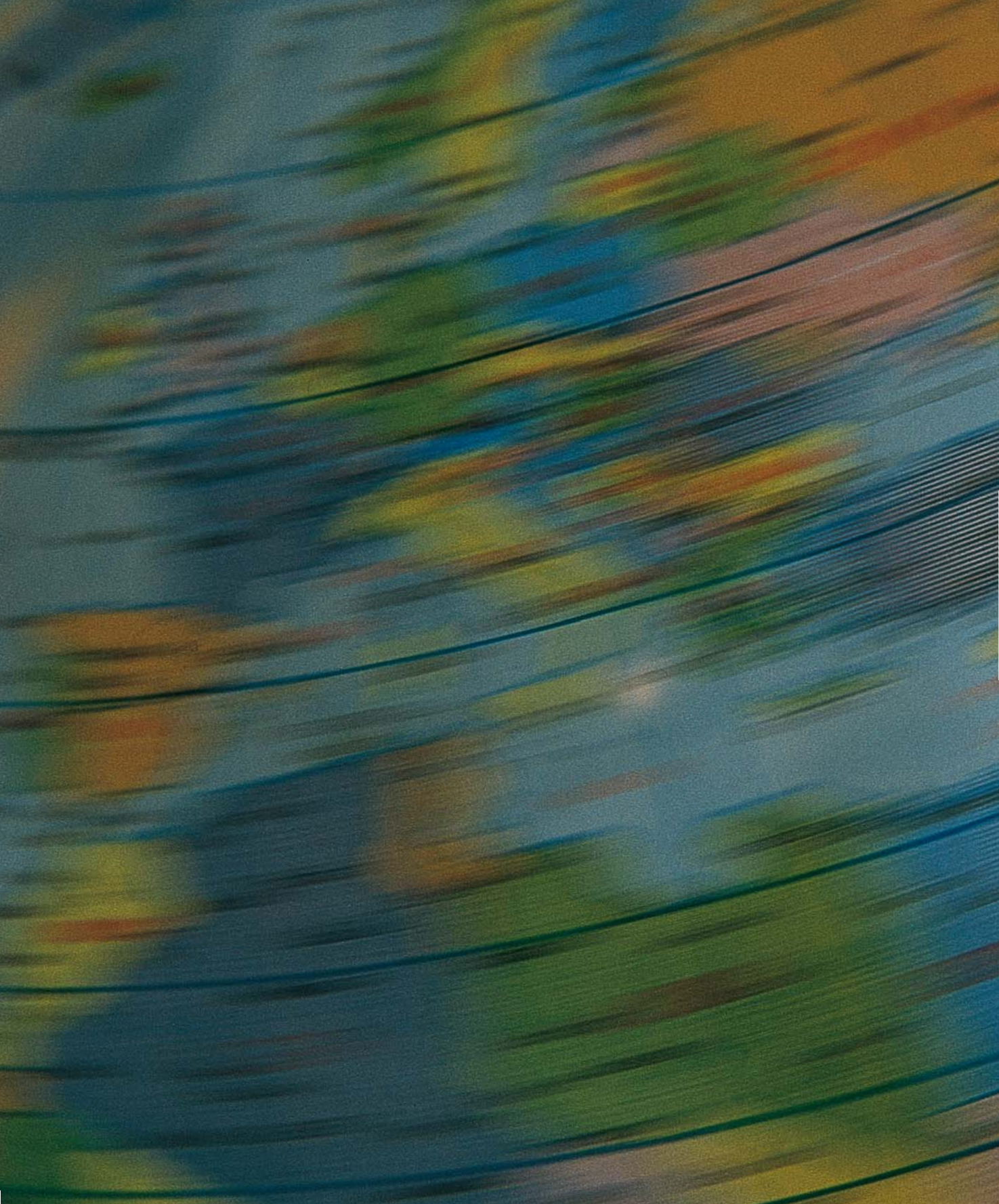





日常便览 rìcháng biànlǎn  
reference



# 时间 shíjiān • time

分针  
fēnzhēn  
minute hand

时针  
shízhēn  
hour hand



钟表  
zhōngbiǎo  
clock



一点五分  
yīdiǎn wǔ fēn  
five past one



一点十分  
yīdiǎn shí fēn  
ten past one



一点十五分  
yīdiǎn shíwǔ fēn  
quarter past one



一点二十分  
yīdiǎn èrshí fēn  
twenty past one



一点二十五分  
yīdiǎn èrshíwǔ fēn  
twenty five past one

秒针  
miǎozhēn  
second hand



一点半  
yīdiǎnbàn  
one thirty



一点三十五分  
yīdiǎn sānshíwǔ fēn  
twenty five to two



一点四十分  
yīdiǎn sìshí fēn  
twenty to two



一点四十五分  
yīdiǎn sānshíwǔ fēn  
quarter to two



一点五十分  
yīdiǎn wǔshí fēn  
ten to two



一点五十五分  
yīdiǎn wǔshíwǔ fēn  
five to two



两点钟  
liǎngdiǎn zhōng  
two o'clock

## 词汇 cíhuì • vocabulary

秒  
miǎo  
second

现在  
xiànzài  
now

一刻钟  
yí kèzhōng  
a quarter of an hour

分钟  
fēnzhōng  
minute

以后  
yǐhòu  
later

二十分钟  
èrshí fēnzhōng  
twenty minutes

小时  
xiǎoshí  
hour

半小时  
bàn xiǎoshí  
half an hour

四十分钟  
sìshí fēnzhōng  
forty minutes

几点了?  
jǐ diǎn le?  
What time is it?

三点了。  
sāndiǎn le.  
It's three o'clock.

# 昼夜 zhòuyè • night and day



午夜 wǎnyè | midnight



日出 rìchū | sunrise



拂晓 fúxiǎo | dawn



早晨 zǎochén | morning



日落  
rìluò  
sunset



正午  
zhèngwǔ  
midday



黄昏 huánghūn | dusk



傍晚 bàngwǎn | evening



下午 xiàwǔ | afternoon

## 词汇 cíhuì • vocabulary

早  
zǎo  
early

你来早了。  
nǐ lái zǎo le.  
You're early.

请准时些。  
qǐng zhǔnshí xiē.  
Please be on time.

几点结束？  
jǐdiǎn jiéshù?  
What time does it finish?

准时  
zhǔnshí  
on time

你迟到了。  
nǐ chí dào le.  
You're late.

待会儿见。  
dài huier jiàn.  
I'll see you later.

天晚了。  
tiān wǎn le.  
It's getting late.

迟  
chí  
late

我马上就到。  
wǒ mǎshàng jiù dào.  
I'll be there soon.

几点开始？  
jǐdiǎn kāishǐ?  
What time does it start?

会持续多久？  
huì chíchù duōjiǔ?  
How long will it last?



# 日历 rìlì • calendar

月  
yuè  
month

年  
nián  
year

一月  
yīyuè  
January

2010



日  
rì  
day

星期一  
xīngqīyī  
Monday

星期二  
xīngqīèr  
Tuesday

星期三  
xīngqīsān  
Wednesday

星期四  
xīngqīsì  
Thursday

星期五  
xīngqīwǔ  
Friday

星期六  
xīngqīliù  
Saturday

星期日  
xīngqīrì  
Sunday

工作日  
gōngzuòrì  
work day

1 2 3 4 5 6 7

星期  
xīngqī  
week

8 9 10 11 12 13 14

15 16 17 18 19 20 21

日期  
rìqī  
date

昨天  
zuótiān  
yesterday

今天  
jīntiān  
today

明天  
míngtiān  
tomorrow

周末  
zhōumò  
weekend

## 词汇 cíhuì • vocabulary

一月  
yīyuè  
January

三月  
sānyuè  
March

五月  
wǔyuè  
May

七月  
qīyuè  
July

九月  
jiǔyuè  
September

十一月  
shíyīyuè  
November

二月  
èryuè  
February

四月  
sìyuè  
April

六月  
liùyuè  
June

八月  
bāyuè  
August

十月  
shíyuè  
October

十二月  
shíèryuè  
December

## 年 nián • years

1900 一九〇〇年 yījiǔlínglíng nián • nineteen hundred

1901 一九〇一年 yījiǔlíngyī nián • nineteen hundred and one

1910 一九一〇年 yījiǔyīlíng nián • nineteen ten

2000 二〇〇〇年 èrlínglíng nián • two thousand

2001 二〇〇一年 èrlínglíngyī nián • two thousand and one

## 季节 jìjié • seasons



春天  
chūntiān  
spring



夏天  
xiàtiān  
summer



秋天  
qiūtiān  
autumn



冬天  
dōngtiān  
winter

## 词汇 cíhuì • vocabulary

世纪  
shìjī  
century

本周  
běnzhōu  
this week

后天  
hòutiān  
the day after tomorrow

今天几号？  
jīntiān jǐhào?  
What's the date today?

十年  
shínián  
decade

上周  
shàngzhōu  
last week

每周  
měizhōu  
weekly

今天是二〇〇二年二月七日。  
jīntiān shì èrlínglíngèr nián èryuè qīrì.

千年  
qiānnián  
millennium

下周  
xiàzhōu  
next week

每月  
měiyuè  
monthly

It's February seventh, two thousand and two.

两周  
liǎngzhōu  
fortnight

前天  
qiántiān  
the day before yesterday

每年  
měinián  
annual



# 数字 shùzì • numbers

0 零 líng • zero

1 一 yī • one

2 二 èr • two

3 三 sān • three

4 四 sì • four

5 五 wǔ • five

6 六 liù • six

7 七 qī • seven

8 八 bā • eight

9 九 jiǔ • nine

10 十 shí • ten

11 十一 shíyī • eleven

12 十二 shí'èr • twelve

13 十三 shí sān • thirteen

14 十四 shí sì • fourteen

15 十五 shí wǔ • fifteen

16 十六 shí liù • sixteen

17 十七 shí qī • seventeen

18 十八 shí bā • eighteen

19 十九 shí jiǔ • nineteen

20 二十 èrshí • twenty

21 二十一 èrshíyī • twenty-one

22 二十二 èrshí'èr • twenty-two

30 三十 sānshí • thirty

40 四十 sìshí • forty

50 五十 wǔshí • fifty

60 六十 liùshí • sixty

70 七十 qīshí • seventy

80 八十 bāshí • eighty

90 九十 jiǔshí • ninety

100 一百 yībǎi • one hundred

110 一百一十 yībǎiyíshí • one hundred and ten

200 二百 èrbǎi • two hundred

300 三百 sānbǎi • three hundred

400 四百 sìbǎi • four hundred

500 五百 wǔbǎi • five hundred

600 六百 liùbǎi • six hundred

700 七百 qībǎi • seven hundred

800 八百 bābǎi • eight hundred

900 九百 jiǔbǎi • nine hundred

1000	一千 yīqiān • one thousand
10,000	一万 yīwàn • ten thousand
20,000	两万 liǎngwàn • twenty thousand
50,000	五万 wǔwàn • fifty thousand
55,500	五万五千五百 wǔwàn wǔqiān wǔbǎi • fifty-five thousand five hundred
100,000	十万 shíwàn • one hundred thousand
1,000,000	一百万 yībǎiwàn • one million
1,000,000,000	十亿 shíyì • one billion

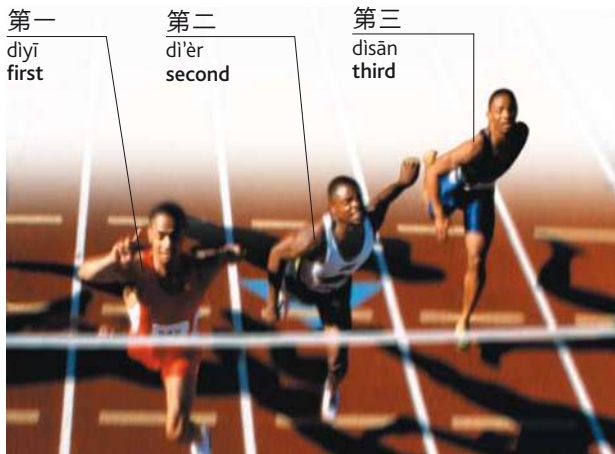

第一  
dìyī  
first

第二  
dì'èr  
second

第三  
dìsān  
third

第四 dìsì • fourth

第五 dìwǔ • fifth

第六 dilìu • sixth

第七 dìqī • seventh

第八 dìbā • eighth

第九 dìjiǔ • ninth

第十 dìshí • tenth

第十一 dìshíyī • eleventh

第十二 dìshíèr • twelfth

第十三 dìshísān • thirteenth

第十四 dìshísì • fourteenth

第十五 dìshíwǔ • fifteenth

第十六 dìshíliù •  
sixteenth

第十七 dìshíqī •  
seventeenth

第十八 dìshíbā •  
eighteenth

第十九 dìshíjiǔ •  
nineteenth

第二十 dì'èrshí •  
twentieth

第二十一 dì'èrshíyī •  
twenty-first

第二十二 dì'èrshíèr •  
twenty-second

第二十三 dì'èrshísān •  
twenty-third

第三十 disānshí • thirtieth

第四十 disìshí • fortieth

第五十 diwǔshí • fiftieth

第六十 dilìushí • sixtieth

第七十 diqīshí • seventieth

第八十 dibāshí • eightieth

第九十 dìjiǔshí • ninetieth

第一百 dìyībǎi • one  
hundredth



# 度量衡 dùliáng héng • weights and measures

## 面积 miànjī • area

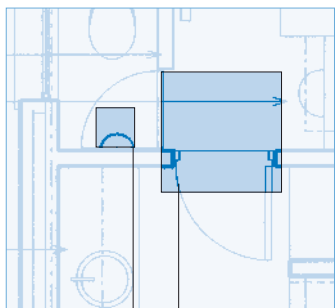

平方英尺  
píngfāng yīngchǐ  
square foot

平方米  
píngfāng mǐ  
square metre

## 距离 jùlí • distance

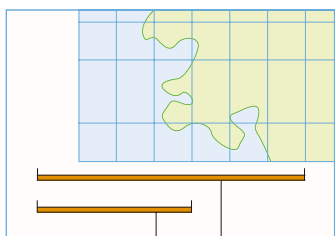

公里  
gōnglǐ  
kilometre

英里  
yīnglǐ  
mile

## 长度 chángdù • length

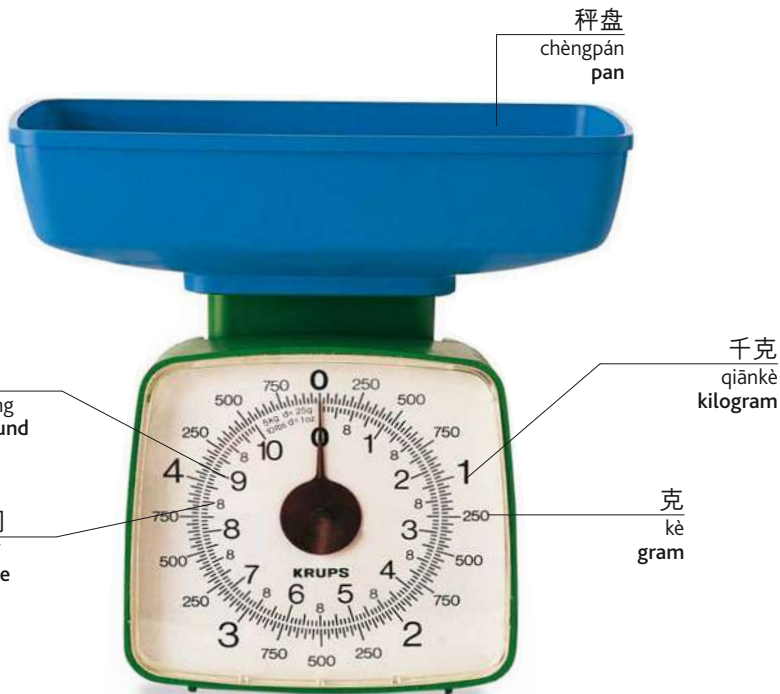
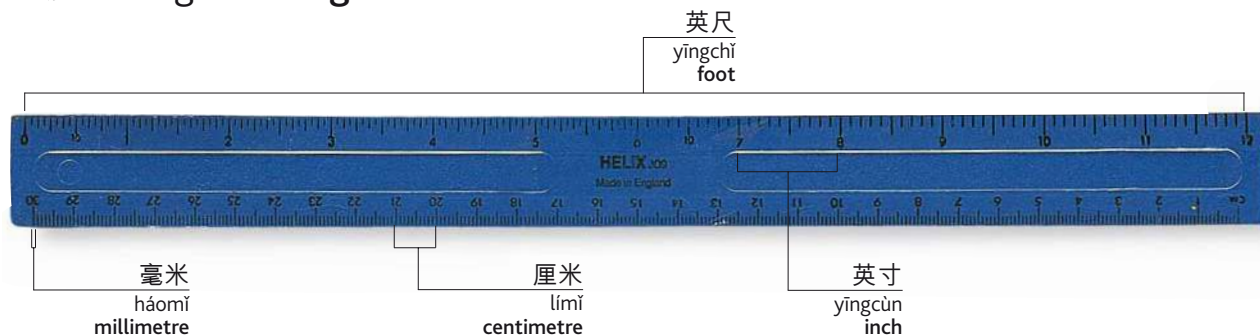

磅秤 bàngchèng | scales

## 词汇 cíhuì • vocabulary

码  
mǎ  
yard

吨  
dūn  
tonne

测量  
cèliáng  
measure (v)

米  
mǐ  
metre

毫克  
háokè  
milligram

称重量  
chēng zhòngliàng  
weigh (v)

容量 róngliàng • capacity

半升  
bànshēng  
half-litre

品脱  
pǐntuō  
pint

容积  
róngjī  
volume

毫升  
háoshēng  
millilitre



量壶 liànghú | measuring jug



液体量器 yètǐ liàngqǐ | liquid measure

词汇 cíhuì •  
vocabulary

加仑  
jiālún  
gallon

夸脱  
kuātuō  
quart

升  
shēng  
litre

容器 róngqì • container



硬纸盒  
yìngzhǐhé  
carton



包  
bāo  
packet



瓶  
píng  
bottle



袋  
dài  
bag



塑料盒 sùliàohé | tub



广口瓶 guǎngkǒupíng | jar



罐  
guǎn  
can

罐头盒 guàntóuhé | tin



喷水器 pēnshuǐqǐ | liquid dispenser



块  
kuài  
bar



软管  
ruǎnguǎn  
tube



卷  
juǎn  
roll



纸盒  
zhǐhé  
pack



喷雾罐  
pēnwùguǎn  
spray can



# 世界地图 shìjiè dìtú • world map

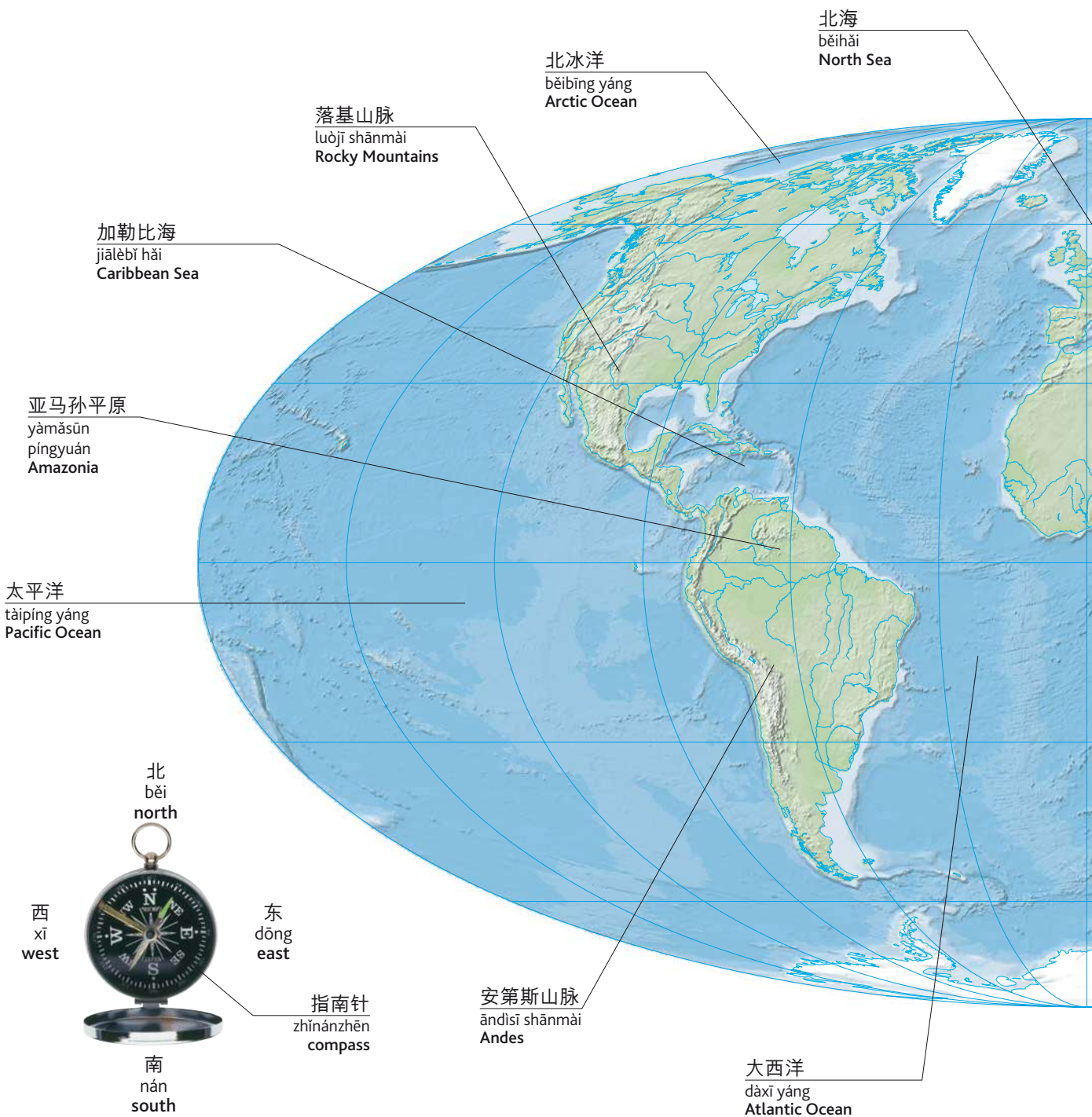

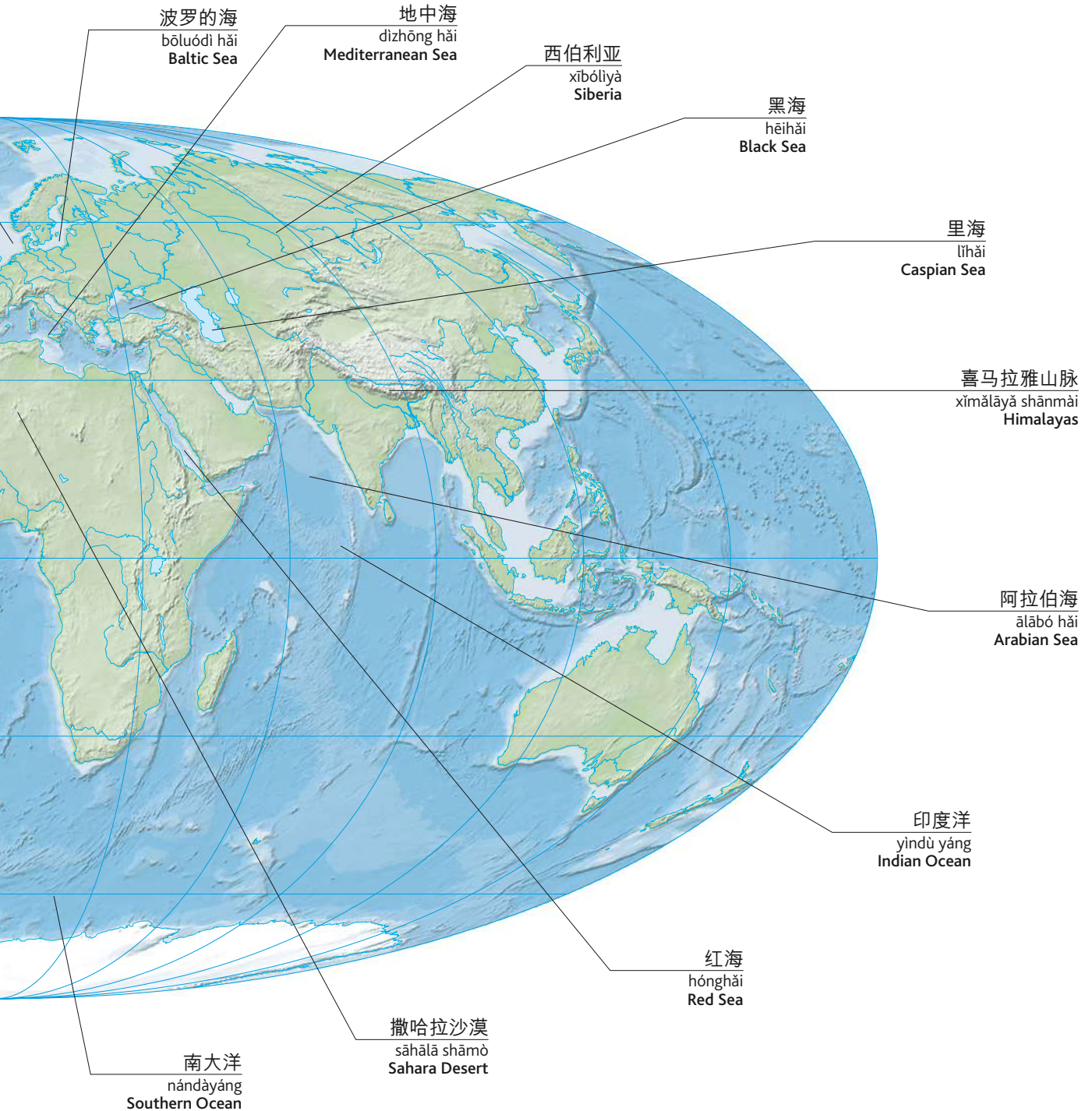



# 北美洲 běiměizhōu • North and Central America



- 1 阿拉斯加 ālāsījiā • Alaska
- 2 加拿大 jiānádà • Canada
- 3 格陵兰 gélínglǎn • Greenland
- 4 美利坚合众国 měilǐjiānhézhòngguó • United States of America
- 5 墨西哥 mòxīgē • Mexico
- 6 危地马拉 wēidīmǎlā • Guatemala
- 7 伯利兹 bólizī • Belize
- 8 萨尔瓦多 sà'ěrwǎduō • El Salvador
- 9 洪都拉斯 hóngdūlāsī • Honduras
- 10 尼加拉瓜 níjiālāguā • Nicaragua
- 11 哥斯达黎加 gēsīdálǐjiā • Costa Rica
- 12 巴拿马 bānámǎ • Panama
- 13 古巴 gǔbā • Cuba
- 14 巴哈马 bāhāmǎ • Bahamas
- 15 牙买加 yámǎijiā • Jamaica
- 16 海地 hǎidi • Haiti
- 17 多米尼加 duōmīnjīā • Dominican Republic
- 18 波多黎各 bōduōlígè • Puerto Rico
- 19 巴巴多斯 bābādūōsī • Barbados
- 20 特立尼达和多巴哥 tèlínídà hé duōbāgē • Trinidad and Tobago
- 21 圣基茨和尼维斯 shèngjīcí hé níwéisi • St. Kitts and Nevis

- 22 安提瓜和巴布达 āntígūā hé bābúdà • Antigua and Barbuda
- 23 多米尼克 duōmīnikè • Dominica
- 24 圣卢西亚 shènglúxīyà • St Lucia
- 25 圣文森特和格林纳丁斯 shèngwénsèntè hé gélínnàdīngsī • St Vincent and The Grenadines
- 26 格林纳达 gélínnàdà • Grenada

## 南美洲 nánměizhōu • South America



- 1 委内瑞拉 wēinèiruīlā • Venezuela
- 2 哥伦比亚 gēlúnbiyà • Colombia
- 3 厄瓜多尔 èguāduōěr • Ecuador
- 4 秘鲁 bìlǔ • Peru
- 5 加拉帕戈斯群岛 jiālāpàgēsī qúndǎo • Galapagos Islands
- 6 圭亚那 guīyànà • Guyana
- 7 苏里南 sūlínán • Suriname
- 8 法属圭亚那 fǎshǔ guīyànà • French Guiana
- 9 巴西 bāxī • Brazil
- 10 玻利维亚 bōlīwéiyà • Bolivia
- 11 智利 zhìlì • Chile
- 12 阿根廷 āgēntíng • Argentina
- 13 巴拉圭 bālāguī • Paraguay
- 14 乌拉圭 wūlāguī • Uruguay
- 15 福克兰群岛 (马尔维纳斯群岛) fúkelán qúndǎo (mǎěrwéinàsī qúndǎo) • Falkland Islands

## 词汇 cíhuì • vocabulary

国家 guójiā country	省 shěng province	地域 dìyù zone
民族 mínzú nation	领土 lǐngtǔ territory	行政区 xíngzhèngqū district
大陆 dàlù continent	殖民地 zhīmíndì colony	地区 dìqū region
主权国家 zhǔquán guójiā state	公国 gōngguó principality	首都 shǒudū capital



## 欧洲 ōuzhōu • Europe

- |   |                                   |   |
|---|-----------------------------------|---|
| 1 爱尔兰 ài'ěrlán • Ireland                  | 30 梵蒂冈 fàndìgāng • Vatican City   | 41 塞尔维亚 sài'ěrweiyà • Serbia  |
| 2 英国 yīngguó • United Kingdom             | 31 西西里岛 xīxīlǐdǎo • Sicily        | 42 波斯尼亚和黑塞哥维那(波黑) bōsīniyà hé hēisàigēwéinà(bōhēi) • Bosnia and Herzegovina |
| 3 葡萄牙 pútáoyá • Portugal                  | 32 马耳他 mǎ'ěrtā • Malta            | 43 阿尔巴尼亚 ā'ěrbāniyà • Albania   |
| 4 西班牙 xībānyá • Spain                     | 33 斯洛文尼亚 sīluòwénni'yà • Slovenia | 44 马其顿 mǎqídùn • Macedonia  |
| 5 巴利阿里群岛 bālǎlǐ qúndǎo • Balearic Islands | 34 克罗地亚 kèluódiyà • Croatia       | 45 保加利亚 bǎojiāliyà • Bulgaria   |
| 6 安道尔 āndào'ěr • Andorra                  | 35 匈牙利 xiōngyá'li • Hungary       | 46 希腊 xīlà • Greece   |
| 7 法国 fāguó • France                       | 36 斯洛伐克 sīluòfákè • Slovakia      | 47 土耳其 tǔ'ěr'qí • Turkey  |
| 8 比利时 bǐlìshí • Belgium                   | 37 乌克兰 wūkèlán • Ukraine          | 48 塞浦路斯 sàipǔlùsī • Cyprus  |
| 9 荷兰 hélán • Netherlands                  | 38 白俄罗斯 bái'élúosī • Belarus      | 49 黑山 hēishān • Montenegro  |
| 10 卢森堡 lúsēnbǎo • Luxembourg              | 39 摩尔多瓦 mó'ěrduōwǎ • Moldova      |   |
| 11 德国 déguó • Germany                     | 40 罗马尼亚 luómǎniyà • Romania       |   |
| 12 丹麦 dānmài • Denmark                    |                                   |   |
| 13 挪威 nuówēi • Norway                     |                                   |   |
| 14 瑞典 ruidiǎn • Sweden                    |                                   |   |
| 15 芬兰 fēnlán • Finland                    |                                   |   |
| 16 爱沙尼亚 àishā'niyà • Estonia              |                                   |   |
| 17 拉脱维亚 lātuowéiyà • Latvia               |                                   |   |
| 18 立陶宛 lìtáowǎn • Lithuania               |                                   |   |
| 19 加里宁格勒 jiālǐnínggèlè • Kaliningrad      |                                   |   |
| 20 波兰 bōlán • Poland                      |                                   |   |
| 21 捷克 jiékè • Czech Republic              |                                   |   |
| 22 奥地利 àodìlì • Austria                   |                                   |   |
| 23 列支敦士登 lièzhīdūnshìdēng • Liechtenstein |                                   |   |
| 24 瑞士 ruìshì • Switzerland                |                                   |   |
| 25 意大利 yìdàlì • Italy                     |                                   |   |
| 26 摩纳哥 mónàgē • Monaco                    |                                   |   |
| 27 科西嘉岛 kēxījiādǎo • Corsica              |                                   |   |
| 28 撒丁岛 sādīngdǎo • Sardinia               |                                   |   |
| 29 圣马力诺 shèngmǎlǐnuò • San Marino         |                                   |   |

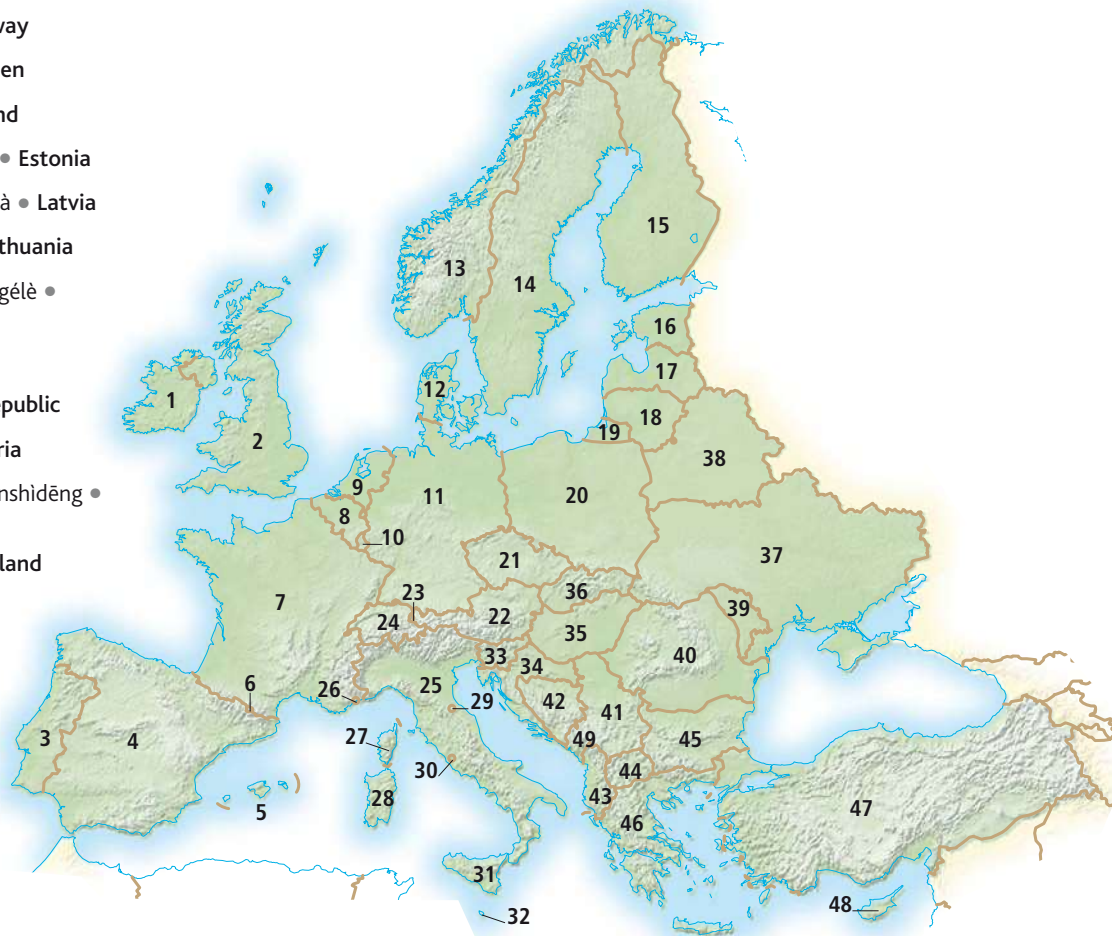

# 非洲 fēizhōu • Africa

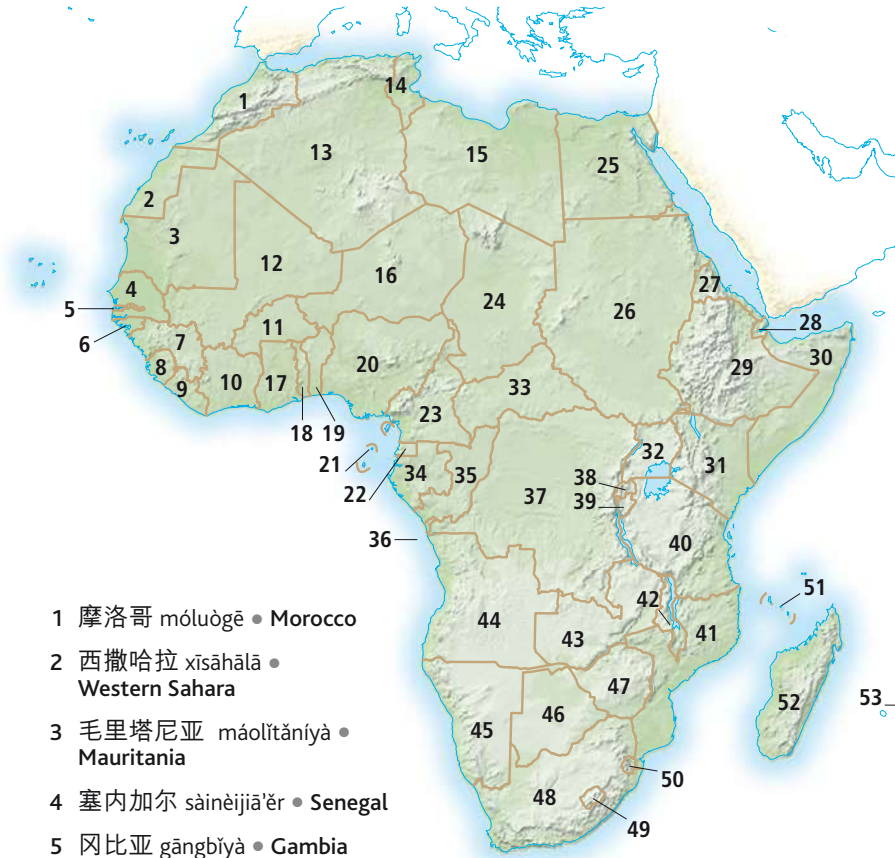

- 1 摩洛哥 móluògē • Morocco
- 2 西撒哈拉 xīsāhālā • Western Sahara
- 3 毛里塔尼亚 máolìtǎniyà • Mauritania
- 4 塞内加尔 sàinèijiǎ'ěr • Senegal
- 5 冈比亚 gāngbìyà • Gambia
- 6 几内亚比绍 jǐ'nèiyà bǐshào • Guinea-Bissau
- 7 几内亚 jǐ'nèiyà • Guinea
- 8 塞拉利昂 sàilālǎng • Sierra Leone
- 9 利比里亚 lìbǐlǐyà • Liberia
- 10 科特迪瓦 kētdédìwǎ • Ivory Coast
- 11 布基纳法索 bùjīnà fǎsuǒ • Burkina Faso
- 12 马里 mǎlǐ • Mali
- 13 阿尔及利亚 ā'ěrjǐlǐyà • Algeria
- 14 突尼斯 tūnísì • Tunisia
- 15 利比亚 lìbǐyà • Libya
- 16 尼日尔 nírì'ěr • Niger
- 17 加纳 jiānà • Ghana
- 18 多哥 duōgē • Togo
- 19 贝宁 bèining • Benin

- 20 尼日利亚 nírìlǐyà • Nigeria
- 21 圣多美和普林西比 shèngduōmèi hé pǔlǐnxībǐ • São Tomé and Príncipe
- 22 赤道几内亚 chìdàojǐnèiyà • Equatorial Guinea
- 23 喀麦隆 kāmàilóng • Cameroon
- 24 乍得 zhàdé • Chad
- 25 埃及 āiji • Egypt
- 26 苏丹 sūdān • Sudan
- 27 厄立特里亚 èlìtèlǐyà • Eritrea
- 28 吉布提 jíbùtí • Djibouti
- 29 埃塞俄比亚 āisà'èbìyà • Ethiopia
- 30 索马里 suǒmǎlǐ • Somalia
- 31 肯尼亚 kěnnìyà • Kenya

- 32 乌干达 wūgāndá • Uganda
- 33 中非共和国 zhōngfēi gònghéguó • Central African Republic
- 34 加蓬 jiāpéng • Gabon
- 35 刚果 gāngguǒ • Congo
- 36 卡奔达(安哥拉) kābēndá(āngēlā) • Cabinda
- 37 刚果民主共和国 gāngguǒ mǐnzhǔ gònghéguó • Democratic Republic of the Congo
- 38 卢旺达 lúwàngdá • Rwanda
- 39 布隆迪 bùlóngdí • Burundi
- 40 坦桑尼亚 tǎnsāngniyà • Tanzania
- 41 莫桑比克 mòsāngbìkè • Mozambique
- 42 马拉维 mǎlāwéi • Malawi
- 43 赞比亚 zànbìyà • Zambia
- 44 安哥拉 āngēlā • Angola
- 45 纳米比亚 nànmǐbìyà • Namibia
- 46 博茨瓦纳 bócíwǎnà • Botswana
- 47 津巴布韦 jīnbābùwéi • Zimbabwe
- 48 南非 nánfēi • South Africa
- 49 莱索托 láisuǒtuō • Lesotho
- 50 斯威士兰 sīwēishìlán • Swaziland
- 51 科摩罗群岛 kēmóluóqúndǎo • Comoros
- 52 马达加斯加 mǎdǎjiāsījiā • Madagascar
- 53 毛里求斯 máolǐqiúsi • Mauritius



# 亚洲 yàzhōu • Asia

- 1 俄罗斯联邦 éluósīliánbāng • Russian Federation
- 2 格鲁吉亚 gēlǔjǐyà • Georgia
- 3 亚美尼亚 yàměiniyà • Armenia
- 4 阿塞拜疆 ā'sàibàijiāng • Azerbaijan
- 5 伊朗 yīlǎng • Iran
- 6 伊拉克 yīlākè • Iraq
- 7 叙利亚 xùliyà • Syria
- 8 黎巴嫩 líbānèn • Lebanon
- 9 以色列 yǐsèliè • Israel
- 10 约旦 yuēdàn • Jordan
- 11 沙特阿拉伯 shàtè'ālábó • Saudi Arabia
- 12 科威特 kēwēitè • Kuwait
- 13 卡塔尔 kätā'ěr • Qatar
- 14 阿拉伯联合酋长国 ālábó liánhé qiúzhǎngguó • United Arab Emirates
- 15 阿曼 āmàn • Oman
- 16 也门 yěmén • Yemen
- 17 哈萨克斯坦 hāsàkèsītǎn • Kazakhstan
- 18 乌兹别克斯坦 wūzǐbiékèsītǎn • Uzbekistan
- 19 土库曼斯坦 tǔkùmànsītǎn • Turkmenistan
- 20 阿富汗 āfùhàn • Afghanistan
- 21 塔吉克斯坦 tǎjǐkèsītǎn • Tajikistan
- 22 吉尔吉斯斯坦 jǐěrgǐsītǎn • Kyrgyzstan
- 23 巴基斯坦 bājǐsītǎn • Pakistan
- 24 印度 yīndù • India
- 25 马尔代夫 mǎ'ěrdàifū • Maldives
- 26 斯里兰卡 sīlǐlánkǎ • Sri Lanka
- 27 中国 zhōngguó • China
- 28 蒙古 měnggǔ • Mongolia
- 29 朝鲜 cháoxiǎn • North Korea
- 30 韩国 hángguó • South Korea
- 31 日本 rìběn • Japan
- 32 尼泊尔 níbó'ěr • Nepal
- 33 不丹 bùdān • Bhutan
- 34 孟加拉国 mèngjiālǎguó • Bangladesh



- 35 缅甸 miǎndiàn • Burma (Myanmar)
- 36 泰国 tàiguó • Thailand
- 37 老挝 lǎowō • Laos
- 38 越南 yuènnán • Viet Nam
- 39 柬埔寨 jiǎnpǔzhài • Cambodia
- 40 马来西亚 mǎlǎixīyà • Malaysia
- 41 新加坡 xīnjiāpō • Singapore

## 大洋洲 dàiyángzhōu • Australasia



- 1 澳大利亚 àodàliyà • Australia
- 2 塔斯马尼亚(岛) tāsīmǎniyà(dǎo) • Tasmania
- 3 新西兰 xīnxīlán • New Zealand

- 42 印度尼西亚 yīndùnìxīyà • Indonesia
- 43 文莱 wénlái • Brunei
- 44 菲律宾 fēilǚbīn • Philippines
- 45 东帝汶 dōngdìwèn • East Timor
- 46 巴布亚新几内亚 bābùyà xīnjīnèiyà • Papua New Guinea
- 47 所罗门群岛 suǒluómén qúndǎo • Solomon Islands
- 48 瓦努阿图 wǎnūātú • Vanuatu
- 49 斐济 fěiji • Fiji



# 小品词与反义词 xiǎopǐncí yǔ fǎnyìcí • particles and antonyms

到...去  
dào...qù  
to

在...上方  
zài...shàngfāng  
over

在...前面  
zài...qiánmian  
in front of

在...上  
zài...shàng  
onto

在...里  
zài...lǐ  
in

在...上面  
zài...shàngmian  
above

在...里面  
zài...lǐmian  
inside

向上  
xiàngshàng  
up

在  
zài  
at

穿越  
chuānyuè  
through

在...之上  
zài...zhīshàng  
on top of

在...之间  
zài...zhījiān  
between

在...附近  
zài...fùjìn  
near

这里  
zhèlǐ  
here

从...来  
cóng...lái  
from

在...下方  
zài...xiàfāng  
under

在...后面  
zài...hòumian  
behind

到...里  
dào...lǐ  
into

在...外  
zài...wài  
out

在...下面  
zài...xiàmian  
below

在...外面  
zài...wàimiàn  
outside

向下  
xiàngxià  
down

超出  
chāochū  
beyond

在...周围  
zài...zhōuwéi  
around

在...旁边  
zài...pángbiān  
beside

在...对面  
zài...duìmian  
opposite

离...远  
lí...yuǎn  
far

那里  
nàlǐ  
there

为  
wèi  
for

沿着...  
yánzhe...  
along

连同  
liántóng  
with

在...之前  
zài...zhīqián  
before

不迟于...  
bùchíyú...  
by

早  
zǎo  
early

现在  
xiànzài  
now

一直  
yìzhí  
always

经常  
jīngcháng  
often

昨天  
zuótiān  
yesterday

第一  
dìyī  
first

每...  
měi...  
every

关于  
guānyú  
about

一点儿  
yìdiǎn'er  
a little

向...方向  
xiàng...fāngxiàng  
towards

越过  
yuèguò  
across

没有...  
méiyǒu...  
without

在...之后  
zài...zhīhòu  
after

直到...  
zhídào...  
until

迟  
chí  
late

以后  
yǐhòu  
later

从不  
cóngbù  
never

很少  
hěنشào  
rarely

明天  
míngtiān  
tomorrow

最后  
zuìhòu  
last

一些  
yìxiē  
some

准确地  
zhǔnquèdì  
exactly

很多  
hěnduō  
a lot

大 dà large	小 xiǎo small	热 rè hot	冷 lěng cold
宽 kuān wide	窄 zhǎi narrow	开 kāi open	关 guān closed
高大 gāodà tall	矮小 ǎixiǎo short	满 mǎn full	空 kōng empty
高 gāo high	低 dī low	新 xīn new	旧 jiù old
厚 hòu thick	瘦 shòu thin	轻 qīng light	黑暗 hēiàn dark
轻 qīng light	重 zhòng heavy	容易 róngyì easy	困难 kùnnán difficult
硬 yìng hard	软 ruǎn soft	空闲 kòngxián free	忙碌 mánglù occupied
潮湿 cháoshī wet	干燥 gānzào dry	强壮 qiángzhuàng strong	虚弱 xūruò weak
好 hǎo good	坏 huài bad	胖 pàng fat	瘦 shòu thin
快 kuài fast	慢 màn slow	年轻 niánqīng young	年老 niánlǎo old
正确 zhèngquè correct	错误 cuòwù wrong	更好 gènghǎo better	更差 gèngchà worse
干净 gānjìng clean	脏 zāng dirty	黑色 hēisè black	白色 báisè white
好看 hǎokàn beautiful	丑 chǒu ugly	有趣 yǒuqù interesting	厌恶 yànwù boring
贵 guì expensive	便宜 piányi cheap	生病的 shēngbìngde sick	健康的 jiànkāngde well
安静 ānjìng quiet	吵闹 chǎonào noisy	开始 kāishǐ beginning	结束 jiéshù end



# 常用语 cháng yòngyǔ • useful phrases

## 基本用语 jīběn yòngyǔ • essential phrases

是  
shì  
Yes

不  
bù  
No

也许  
yěxǔ  
Maybe

请  
qǐng  
Please

谢谢  
xièxiè  
Thank you

不用谢  
bùyòngxiè  
You're welcome

抱歉；打扰一下  
bàoqiàn, dǎrǎoyíxià  
Excuse me

对不起  
duìbuqǐ  
I'm sorry

不要  
bùyào  
Don't

好  
hǎo  
OK

很好  
hěnhǎo  
That's fine

正确  
zhèngquè  
That's correct

不对  
búduì  
That's wrong

问候 wèn hòu •  
greetings

你好  
nǐ hǎo  
Hello

再见  
zàijiàn  
Goodbye

早上好  
zǎoshang hǎo  
Good morning

下午好  
xiàwǔ hǎo  
Good afternoon

晚上好  
wǎnshang hǎo  
Good evening

晚安  
wǎn'ān  
Good night

你好吗？  
nǐ hǎo ma?  
How are you?

我叫...  
wǒ jiào...  
My name is...

您怎么称呼？  
nín zěnmē chēnghū?  
What is your name?

他/她叫什么名字？  
tā/tā jiào shénme míngzì?  
What is his/her name?

我介绍一下...  
wǒ jièshào yíxià...  
May I introduce...

这是...  
zhèshì...  
This is...

很高兴见到你  
hènggāoxìng jiàndào nǐ  
Pleased to meet you

待会儿见  
dài huì'er jiàn  
See you later

标志 biāozhì • signs

游客问询处  
yóukè wèn xún chù  
Tourist information

入口  
rùkǒu  
Entrance

出口  
chūkǒu  
Exit

紧急出口  
jǐnjí chūkǒu  
Emergency exit

推  
tuī  
Push

危险  
wēixiǎn  
Danger

禁止吸烟  
jìnzhǐ xī yān  
No smoking

故障  
gùzhàng  
Out of order

开放时间  
kāifàng shíjiān  
Opening times

免费入场  
miǎnfèi rùchǎng  
Free admission

全天开放  
quántiān kāifàng  
Open all day

减价  
jiǎnjià  
Reduced price

打折  
dǎshé  
Sale

进前敲门  
jìnqiánqiāomén  
Knock before entering

禁止践踏草坪  
jìnzhǐ jiàntàcǎopíng  
Keep off the grass

求助 qiúzhù • help

你能帮帮我吗？  
nǐ néng bāngbāng wǒ ma?  
Can you help me?

我不懂  
wǒ bù dǒng  
I don't understand

我不知道  
wǒ bù zhīdào  
I don't know

你说英语吗？  
nǐ shuō yīngyǔ ma?  
Do you speak English?

你说中文吗？  
nǐ shuō zhōngwén ma?  
Do you speak Chinese?

我会说英语  
wǒ huì shuō yīngyǔ  
I speak English

我会说西班牙语  
wǒ huì shuō xībānyáyǔ  
I speak Spanish

请说得再慢些  
qǐng shuōdé zài màn xiē  
Please speak more slowly

请帮我写下来  
qǐng bāng wǒ xiě xiàlái  
Please write it down for me

我丢了...  
wǒ diūle...  
I have lost...

方向 fāngxiàng •  
directions

我迷路了  
wǒ mílùle  
I am lost

...在哪里?  
zài nǎlǐ  
Where is the...?

最近的...在哪里?  
zúijìnde...zài nǎlǐ?  
Where is the nearest...?

洗手间在哪儿?  
xǐshǒujiān zài nǎer?  
Where are the toilets?

我怎么去...?  
wǒ zěnmē qù...?  
How do I get to...?

右转  
yòuzhuǎn  
To the right

左转  
zuǒzhuǎn  
To the left

向前直行  
xiàngqián zhíháng  
Straight ahead

到...有多远?  
wǒ zěnmē qù...?  
How far is...?

交通标志 jiāotōng  
biāozhì • road signs

各方通行  
gēfāng tōngxíng  
All directions

谨慎驾驶  
jǐnshèn jiàshǐ  
Caution

禁入  
jìnrù  
No entry

减速  
jiǎnsù  
Slow down

绕行  
ràoxíng  
Diversion

靠右行驶  
kào yòucè xíngshǐ  
Keep to the right

高速公路  
gāosùgōnglù  
Motorway

禁止停车  
jìnzhǐ tíngchē  
No parking

禁止通行  
jìnzhǐ tōngxíng  
No through road

单行道  
dānxíngdào  
One-way street

其他方向通行  
qítāfāngxiàng tōngxíng  
Other directions

只限本区居民(停车)  
zhǐxiànběnrūjūmín (tíngchē)  
Residents only

道路管制  
dàolùguǎnzhi  
Roadworks

危险弯道  
wēixiǎnwāndào  
Dangerous bend

住宿 zhùsù •  
accommodation

我订了房间  
wǒ dīng le fángjiān  
I have a reservation

餐厅在哪儿?  
cāntīng zài nǎ'ér  
Where is the dining room?

我的房间号是...  
wǒ de fángjiān hào shì...  
My room number is ...

几点吃早餐?  
jǐdiǎn chī zǎocān?  
What time is breakfast?

我将在...点回来  
wǒ jiāng zài...diǎn huílái  
I'll be back at ... o'clock

我明天离开  
wǒ míngtiān líkāi  
I'm leaving tomorrow

饮食 yǐnshí • eating  
and drinking

干杯!  
gānbēi  
Cheers!

好吃极了  
hàochíjǐle  
It's delicious

难吃死了  
nánchīsǐle  
It's awful

我不喝酒  
wǒ bù hējiǔ  
I don't drink

我不抽烟  
wǒ bù chōuyān  
I don't smoke

我不吃肉  
wǒ bù chīròu  
I don't eat meat

够了, 谢谢  
gòule, xièxiè  
No more for me,  
thank you

请再来点儿  
qǐng zàilái diǎn'er  
May I have some more?

我们要结账  
wǒmen yào jiézhàng  
May we have the  
bill?

请开张收据  
qǐng kāi zhāng shōujù  
Can I have a receipt?

禁烟区  
jìnyānqū  
No-smoking area

健康 jiànkāng • health

我不舒服  
wǒ bù shūfu  
I don't feel well

我难受  
wǒ nánshòu  
I feel sick

离这儿最近的医生  
电话是多少?  
lí zhè'er zuìjìn de yīshēng  
diànhuà shì duōshǎo?  
What is the telephone  
number of the nearest  
doctor?

我这儿疼  
wǒ zhè'er téng  
It hurts here

我发烧了  
wǒ fāshāole  
I have a temperature

我怀孕...个月了  
wǒ huáiyùn...gè yuèle  
I'm ... months pregnant

我需要...处方  
wǒ xūyào...chǔfāng  
I need a prescription for ...

我通常服用...  
wǒ tōngcháng fúyòng...  
I normally take ...

我对...过敏  
wǒ duì...guòmǐn  
I'm allergic to ...

他好吗?  
tā hǎoma?  
Will he be all right?

她好吗?  
tā hǎoma?  
Will she be all right?



## 中文索引 zhōngwén suǒyǐn • Chinese index

## A

ā'ěrbanliá 316  
 ā'ěrjǐliá 317  
 ā'sàibàijiāng 318  
 āfùhàn 318  
 āgēntíng 315  
 ài 287  
 ài'ěrlán 316  
 àiji 317  
 àiqíngpiān 255  
 àisàilébìyà 317  
 àishā'nìyà 316  
 àixiǎo 321  
 ālābó hái 313  
 ālābó liánhé qiúzhàngguó 318  
 ālāsījī 314  
 àmàn 318  
 àn càidán diǎncài 152  
 ànbǎn 68  
 ànbiānlánzhuāng 214  
 ānchún 119  
 ānchúndàn 137  
 āndào'ěr 316  
 āndìsī shānmài 312  
 āngēlā 317  
 àngsī 310  
 ànjiànnqū 97, 99  
 ānjīng 321  
 ānkāngyú 120  
 ànmǎ 235  
 ànmiányào 109  
 ànmó 54  
 ànpéi 60  
 ānquán 75, 212  
 ānquán biézhēn 47  
 ānquán dàohúlán 298  
 ānquán zuàntóu 80  
 ānquándài 198, 211  
 ānquánhúlán 246  
 ānquánmào 186  
 ānquánqínáng 201  
 ānquánshànglèi 228  
 ànshì 271  
 ānshù 296  
 āntígū hé bābúdà 174  
 ānzhuāng 177  
 ānzuó 242  
 àodàliyà 319  
 àodìlì 316  
 àozhōujiānguó 129

## B

B chāo 52  
 bà 249  
 bā 308  
 bǎ...zhòng yú pénnèi 91  
 bābāduōsī 314  
 bābǎi 308  
 bābiānxíng 164  
 bābúyà xīnjīnèiyà 319  
 bāhāmǎ 314  
 bái(pútáojiù) 145  
 bái'è 288

bái'élúosī 316  
 báiculi 127  
 bāifēnbí 165  
 báigānlǎo 136  
 báigé 272  
 bāihé 110  
 bǎihuò shāngdiàn 105  
 bǎijǐbǐng 139  
 bǎikēquánshù 163  
 bǎilándì 145  
 bǎilǐxiāng 133  
 báimǐ 130  
 báimiànbào 139  
 báinèizhàng 51  
 báiqiǎokèlì 113  
 báiróu 118  
 báisé 39, 274, 321  
 báiyáng 296  
 báiyèchuāng 58, 63  
 báiyí 295  
 bǎiyóulùmiàn 187  
 bǎizhuōzǐ 64  
 bǎijiǎo 133  
 bǎijīsītān 318  
 bālāgu 315  
 bālěiwú 255  
 bālěiwúqún 191  
 bǎilǎi qúndǎo 316  
 bǎluókèshì 301  
 bàn xiāoshí 304  
 bānmǎ 314  
 bànbiān 246  
 bàncǎng 223  
 bānchē 197  
 bàndǎo 282  
 bāndòu 131  
 bàndúlìshì 58  
 bàng 310  
 bàngbàngtáng 113  
 bàngchèng 310  
 bānggēgū 257  
 bàngōngtóu 298  
 bàngōngshèbèi 172  
 bàngōngshì 24, 172, 174  
 bàngōngyòngpǐn 173  
 bàngōngzhuó 172  
 bàngqiú 228  
 bàngqiú shòutào 228  
 bàngwǎn 305  
 bàngxíng niúkòu 31  
 bǎnhuà 275  
 bānjī 210, 212  
 bānjiān 246  
 bànjīng 164  
 bānkuài 283  
 bànlǐ dēngjī shǒuxù 212  
 bànlǐ dēngjī shǒuxùchù 213  
 bànlídou 131  
 bānmǎ 291  
 bānqián 81  
 bānqiú 225  
 bānqiú qiúyuán 225  
 bànrúnnǎilào 136

bànsǎng 311  
 bànsǎshù 101  
 bànsǎshou 80  
 bàntuōzhǐ niúnnǎi 136  
 bànyán 288  
 bànyīngnǎilào 136  
 bānyúngōng 100  
 báo 321  
 báo 37, 311  
 báo 64  
 báoōn 189  
 báobīngjuǎn 155  
 báocuībīnggān 139, 156  
 báocún 177  
 báofēngyú 287  
 báogāncuībīng 139  
 bàogào 174  
 bàoguāngbiào 270  
 bàoguāngjī shùqǐ 270  
 bàoguó 99  
 bàohuā 78  
 bàohuábǎn 79  
 báojiǎliá 316  
 báojiānbǐng 157  
 báojiāojiāng 83  
 bàokǎntíng 112  
 bǎolingqiú 249  
 bǎolingqiú píng 249  
 bǎolingqiú yúndòng 249  
 bàomíhuà 255  
 bàonuǎn nèiyī 267  
 bāopi 21  
 bàopian 119  
 bāopiqiǎn 81  
 bàoshí 36, 288  
 bàoshìjīn 181  
 bǎoshìshuāng 41  
 bàotāi 203, 207  
 bǎowēnpíng 267  
 bàoxián 203  
 bǎoxiāng 254  
 bǎoxiāngàng 198  
 bǎoxiānhé 60, 203  
 bǎoxiānsī 60  
 báozǎ 47  
 bàozhǐ 112  
 báozhuāngzhǐ 111  
 bàozǐ 81  
 bàozǐgānlán 123  
 bàpán 273  
 básāizuàn 150  
 bāshí 308  
 bāshou 88  
 bāsōngguǎn 257  
 bàtái 150  
 bāxi 315  
 bāxiuguó 129  
 bāxīn 273  
 báyà 50  
 báyuè 306  
 bèi 13, 165  
 bèi 312  
 bèibānqiú 283

bèibào 31, 37, 267  
 bèibīng yáng 312  
 bèidài 37  
 bèidiàn 150  
 bèidiyinguān 257  
 bèigāo 180  
 bèigàorén 181  
 bèihǎi 312  
 bèihuīgūxiàn 283  
 bèiji 283  
 bèiji xióng 291  
 bèijīngmùbù 254  
 bèijiquān 283  
 bèikè 265  
 bèikuòjǐ 16  
 bèiměizhōu 314  
 bèining 317  
 bèiqi 294  
 bèirù 74  
 bèishāng 25  
 bèishuà 73  
 bèiwànglù 173  
 bèixin 30, 33, 35, 250  
 bèiyòng lúntāi 203  
 běncǎo liáofá 55  
 bēngdài 47  
 bèngjí 248  
 běnléi 228  
 běnshēngdēng 166  
 běnwèihào 256  
 běnzhōu 307  
 biāncái 220, 223, 230  
 biānfú 290  
 biānjí 191  
 biānjiān 173  
 biànjiào jīngtóu 270  
 biānsù 207  
 biānsùgǎn 201, 207  
 biānsùxiāng 202, 204  
 biānxiàn 220, 221, 225, 226, 229, 230  
 biānxiéshì CD bōfàngjī 268  
 biānxiéshì shèxiàngjī 260, 269  
 biànyāqǐ 60  
 biānzhi 277  
 biànzhīyán 288  
 biānzhizhēn 277  
 biānzhuāng 33, 34  
 biāocéngtǔ 85  
 biāohújiàng 82  
 biāohúshuā 82  
 biāohútái 82  
 biāoqiān 172, 173  
 biāoqiāng 234  
 biāoshí 31  
 biāoxiōngdì 22  
 biāozhūn gānshù 233  
 biāozhūnjiān 100  
 bídǎi 163  
 biǎdēng 62  
 bídòu 19  
 bǐji 242  
 bǐji 175, 191

bǐjià 238  
 bǐjiān 163  
 bǐjiběn 163, 172  
 bǐjiběn diànnǎo 175, 176  
 bǐjīnyīngzhuāng 264  
 bǐkōng 14  
 bìlìshì 316  
 bìlù 63  
 bìlù 315  
 bìlútái 63  
 bǐng 36, 187  
 bǐng 120, 151, 272, 287  
 bǐngbào 286  
 bǐngchá 149  
 bǐngdú 44  
 bǐngfáng 48  
 bǐnggān 113, 141  
 bǐnghé 284  
 bǐngjǐlǐng 137, 149  
 bǐngkāfēi 148  
 bǐngkuài 151  
 bǐngliè zhēngqiú 221  
 bǐnglǐkē 49  
 bǐngqiú 224  
 bǐngqiú chǎng 224  
 bǐngqiú qiúyuán 224  
 bǐngshàng liúshí 247  
 bǐngtóng 150  
 bǐngǔ 17  
 bǐngxī yánliào 274  
 bǐngxiāng 67  
 bǐngxié 224, 247  
 bǐngzhù 287  
 bǐpiāo 238  
 bìqǐ 124  
 bìqiú 231  
 bisàbǐng 154, 155  
 bisàbǐngdiàn 154  
 bisǎi 229, 230  
 bitóng 172  
 bixiè 44  
 biyè 26  
 biyèdiǎnlǐ 169  
 biyèshēng 169  
 biyóu 24  
 biyún 21  
 biyúntào 21  
 biyúnyào 21  
 bizhǐ 82  
 bizhǐ niánhéjī 82  
 bízǐ 14  
 bó 257, 289  
 bōcài 123  
 bōcháng 179  
 bōciwǎn 31  
 bōdúolíngé 314  
 bōertúpútáojiù 145  
 bōfāng 178, 269  
 bōhào 99  
 bōhe 133  
 bōhechá 149  
 bōhēi 316  
 bōhetáng 113

- bōji 77  
 bōjīcāo 250  
 bōlán 316  
 bōlàng 241  
 bōlànggǔ 74  
 bōlí 69  
 bōlí qimín 65  
 bōlibàng 167  
 bōlibèi 150, 152  
 bōlipíng 166  
 bōliwéiyà 315  
 bōlizi 314  
 bōluó 128  
 bōluódi hǎi 313  
 bōluózhi 149  
 bōshixuèwéi 169  
 bōshìniyà hé hēisàigēwéinà 316  
 bōwùguǎn 261  
 bōzhōng 90, 183  
 bùchíyú... 320  
 bùdǎn 318  
 bùdīngmǐ 130  
 bùhán fúwùfèi 152  
 bùhánzhifāngde 137  
 bùjīnà fāsuo 317  
 bùjīng 178, 254  
 bùlǐ gānlǎo 142  
 bùliào 276  
 bùlóngdǐ 317  
 bùpǐ 277  
 bǔrú 53  
 bǔrú dòngwù 290  
 bǔrú xiōngzhào 53  
 bǔtāipiàn 207  
 bùxíng rénsì 47  
 bùxíngqū 299  
 bùxíngxuē 37  
 bùxiàngāng 79  
 bùyù 20  
 bùzhāngguō 69  
 bùzhuō 245
- C**  
 cā 77  
 cǎchuáng 68  
 cǎidān 148, 153, 154  
 cǎidǎnlán 177  
 cǎidì 182  
 cǎidòu 131  
 cǎifāngjizhè 179  
 cáifēng 191  
 cáifengdiàn 115  
 càigēng 122  
 cǎihóng 287  
 cǎihuā 124  
 cǎijyuàn 155  
 cáiliào 79  
 cáipàn 225, 226, 227, 229, 230  
 cáipiào 112  
 cǎipǔ 85  
 cǎisèlàbì 274  
 cǎisèqiānbǐ 163  
 cǎishuǐ 239  
 cǎiyáo 153  
 cǎizhāi 91  
 cǎiziyóu 135  
 cānchá 65, 153  
 cānchē 209
- cānchǐ 65  
 cāndào 65  
 cándòu 122, 131  
 cāngkǔ 216  
 cāngmén 210, 281  
 cāngshù 290  
 cāngsuān 152  
 cāngying 295  
 cānhòutiāndiǎn 153  
 cānjiā 174  
 cānjīn 65, 152  
 cānjīn tàohuán 65  
 cānjīnzhǐ 154  
 cānjīn tǐngchēchù 195  
 cānjù 64, 65  
 cānjù bǎifāng 65, 152  
 cānjù lǐshìjiā 67  
 cānjùdiàn 64  
 cāntīng 64, 101  
 cǎnzhā chūlǐqǐ 61  
 cǎnzhuō 64  
 cǎo 87  
 cǎochǎng 285  
 cǎodài 88  
 cǎodi 90  
 cǎoméi 127  
 cǎoméi nǎixi 149  
 cǎomǐ 130  
 cáopáo 78  
 cǎopíng 85, 262  
 cǎotǔ 275  
 cǎoyào 108  
 cǎoyàochá 149  
 cáoyuán 285  
 cǎozòng shǒubǐng 269  
 cǎozuò zhuāngzhì 201, 204  
 cǎozuótái 66  
 cǎshāng 46  
 cǎshì 77  
 cǎshǒujīn 73  
 cāsù 67  
 CD bōfāngjī 268  
 cèliáng 310  
 céngyābān 79  
 cètí 237  
 cèxián 240  
 chá 144, 149, 156, 184  
 chā 88  
 chábāo 144  
 chábēi 65  
 chāchē 186, 216  
 chāchi 65  
 chādiǎn 233  
 cháhú 65  
 chāhuā 111  
 chāikāi 277  
 cháiyou 199  
 cháiyóujīchē 208  
 chājī 62  
 chājī 91  
 chākǎkǒu 97  
 chǎn 88  
 chǎnchú 294  
 chǎndiào 82  
 cháng 32, 165  
 cháng qūgūnqǐ 249  
 chángbǐng sàozhou 77  
 chángbǐng shēn píngdǐguō 69
- chángbǐng xiūlǐjiǎn 88  
 chángbǐngsháo 68  
 chángbō 179  
 chángcǎoqū 232  
 chángdì 257  
 chángdù 310  
 chángfāngxíng 164  
 chángghào 257  
 chángjībǎn 179  
 chángjīnglù 291  
 chánglǐ 130  
 chánglǔ (zhìwù) 86  
 chángmáorón gwǎnjù 75  
 chángmáoróng wǎnjùxióng 75  
 chāngpéng 260  
 chāngpéngchē 199  
 chāngqiāo huáxuē 247  
 chāngtiào nǎiyóu jiǎnxīn diǎnxīn 140  
 chāngtóng xiàngjiǎoxuē 31  
 chāngtóngwǎ 35  
 chāngtǔ lǚxíng 243  
 chāngtúqìchē 196  
 chāngyá 291  
 chāngyí 250, 262  
 chǎnkē 49  
 chǎnkē bǐngfāng 48  
 chǎnkē yǐshēng 52  
 chǎnqián 53  
 chǎnqió 223  
 chǎnyīnqín 257  
 chǎnzi 265  
 cháo 286  
 chǎo 67  
 chǎocài 158  
 chǎochē 195  
 chǎochū 320  
 chǎoguō 69  
 chǎoji shìchǎng 106  
 chǎojiàn 157  
 chǎonào 321  
 chǎoshēngbō (jiǎnchá) 52  
 chǎoshì 321  
 chǎowǎng 244  
 chǎoxiǎn 318  
 chǎoxiǎnjì 124  
 chǎoyīnsù fěiji 211  
 chǎozhǐ 159  
 chǎozhōng xínglǐ 212  
 chāpiàn 60  
 chātào 91  
 chātóu 60  
 chàyè 144  
 chǎzuò 60  
 chē 272  
 chēbǎ 207  
 chēchuāng 209  
 chēdēng 207  
 chēdēng kāiguān 201  
 chēdīng 203  
 chēdīng xínglǐjià 198  
 chēfēi 197, 209  
 chēhuò 203  
 chējià 206  
 chēkǒu 58  
 chēkuāng 207  
 chēlián 206  
 chēlún 198, 207
- chēmén 196, 198  
 chēmén bǎshou 200  
 chéncǐ 180  
 chéng 165  
 chéng 69, 98, 118  
 chéng zhòngliàng 310  
 chéngbào 300  
 chénggǎntiào 234  
 chéngjī lièchē 209  
 chéngkè 216  
 chéngniánrén 23  
 chéngpán 310  
 chéngqiāo huáxíng 247  
 chéngshúde 129  
 chéngwèi 23  
 chéngxù 176  
 chéngzhèn 298  
 chéngzhuānpibǎn 186  
 chéngzi 121  
 chénjīyǎn 288  
 chènli 32  
 chènqún 35  
 chènshān 32  
 chényi 32  
 chènzhǐ 83  
 chēpái 198  
 chēpiào 209  
 chēshēn 202  
 chēsùbiào 201, 204  
 chēsuo 207  
 chēxiānggējiàn 209  
 chēxiào 79  
 chēzhá 207  
 chēzhāndǎng 209  
 chēzuò 206  
 chí 305, 320  
 chí 64  
 chibǎng 119, 293  
 chícún 165  
 chidào 283  
 chidào jīnèiyà 317  
 chidòu 131  
 chīgǔ 17  
 chiguān 50  
 chílún 206  
 chíqiú chùdìdēfēn 221  
 chīshuǐ 238  
 chīshuǐxiàn 214  
 chítáng 85  
 chitiēkuàng 289  
 chízi 163  
 chōngdiànshì diànzhuàn 78  
 chōnglǎng 241  
 chōnglǎng yùndòngyuán 241  
 chōnglǎngbǎn 241  
 chōngqì chuāngdiàn 267  
 chōngqì xiūdài 45  
 chōngqìshì xiāngpítīng 215  
 chōngwù siliào 107  
 chōngwùshāngdiàn 115  
 chōngxī 38, 271  
 chōngxīn jiārè 154  
 chǒu 321  
 chǒujīn 239  
 chóumǎ 272  
 chōushuǐ mǎtǒng 61, 72  
 chōuti 66, 70, 172  
 chòuyǎngcéng 286
- chōuyóuyānjī 66  
 chú 165  
 chuāizi 81  
 chuān 214  
 chuānchǎng 217  
 chuāndòng zhuāngzhì 202  
 chuāng 70  
 chuāngdān 71, 74  
 chuāngdiàn 70, 74  
 chuānghù 58, 186, 197, 210  
 chuāngjiàobǎn 71  
 chuāngkètīe 47  
 chuāngkǒu 96, 98  
 chuānglián 63  
 chuāngmǎn 63  
 chuāngshāng 46  
 chuāngshāng yòngpǐn 71  
 chuāngtóubǎn 70  
 chuāngtóudēng 70  
 chuāngtóuguī 70  
 chuāngwéi 71  
 chuāngzhào 70  
 chuānpào 180  
 chuānqiú 220, 221, 223, 226  
 chuānrǎn 44  
 chuānròuqiān 68  
 chuānshàng chūfáng 214  
 chuānshǒu 214  
 chuānsòngdài 106  
 chuāntǐ 214, 240  
 chuántóu 240  
 chuánwéi 240  
 chuánwù 214, 216  
 chuānxún 180  
 chuānyuè 320  
 chuānzǎng 214  
 chuānzhen 98, 172  
 chuānzhen 277  
 chuānzhenjī 172  
 chuānzǐ 186  
 chúcǎoji 91, 183  
 chúchén 71  
 chúchòuji 73, 108  
 chūdào 68  
 chūdidēfēn 220  
 chúfā 213  
 chúfā tiàoshuǐ 239  
 chúfáng 66, 152  
 chúfáng 45  
 chúfáng diànjī 66  
 chúfáng yòngpǐn 105  
 chúfātái 238  
 chúguī 66  
 chuidiào zhōnglèi 245  
 chuifēngjī 38  
 chuǐgǎn 38  
 chuǐxi 141  
 chuǐzhǐ 165  
 chuǐzhǐwéiyì 210  
 chuǐzi 80  
 chujǎo 295  
 chujǎ 226  
 chujú 110, 297  
 chujū 68  
 chujū 225, 228  
 chūkǒu 194  
 chūlǐgān jīngde 121  
 chūlǐqǐ 176



- chún 14  
 chúnàyuán 96  
 chúncai 40  
 chúnniú'nài 136  
 chúnshuà 40  
 chūntiān 307  
 chúnxiànbì 40  
 chūqikǒu 61  
 chūquán 237  
 chūrúgǎng tóngdào 216  
 chùshā 229  
 chùshēng 26, 52  
 chùshēng zhèngmíng 26  
 chùshēngqián 52  
 chùshēngshí tizhōng 53  
 chùshī 190  
 chùshīmào 190  
 chùtōu 88  
 chùwǎng 230  
 chūwúguī 62  
 chūxù 96  
 chūxù zhànghù 96  
 chūyí 165  
 chūyuàn 48  
 chūzúchē sǐjī 190  
 chūzúchēzhàn 213  
 cǐkàidiànhuà 99  
 cǐqī 105  
 cǐshāng 46  
 cǐtiē 167  
 cǐwěi 290  
 cǐxiù 277  
 cōng 125  
 cōng...lái 320  
 cōngbù 320  
 cōngtóu 125  
 CT sāomiáo 48  
 cù 135, 142  
 cūfēng 277  
 cuì 127  
 cuímián liáofǎ 55  
 cùlǐ 127  
 cūlǐxiàomàifēn 130  
 cúnchūqǐ 176  
 cūnǐ wàitào 31  
 cūnǐjiákè 33  
 cúnkuǎndān 96  
 cúnǔ 96  
 cúnzhuāng 299  
 cuōdāo 81  
 cuòwù 321  
 cùxiāo hǎibào 106  
 cùzì 159  
 cùzide 143
- D**  
 dà 321  
 dàán 163  
 dàbīmùyùpiàn 120  
 dàcháng 18  
 dàchuí 187  
 dàchūxué 46  
 dǎdànqǐ 68  
 dàdòu 131  
 dàduìxiá 121  
 dàhān 71  
 dàhào 257  
 dàhāqian 25
- dàhuízuǎn 247  
 dàhuǒjī 112  
 dài 311  
 dài zhǐjiáde bǐjǐbǎn 173  
 dàibīngshuǐhú 65  
 dàibǔ 94  
 dàibǔlǐng 180  
 dàichānde 52  
 dàihuáng 127  
 dàikuǎn 96  
 dàiqiú 222  
 dàishù 291  
 dàjiàotáng 300  
 dàjiyuèqǐ 257  
 dàkǒngqǐ 173  
 dàliáng 186  
 dàliào 133  
 dàlǐshí 288  
 dàlù 282, 315  
 dàlùjǐ 99  
 dàmai 130, 184  
 dàmen 182  
 dànmóji 78  
 dàn 137  
 dànbái 137  
 dànbáishí 288  
 dànbàitǎnbǐng 140  
 dànbǎn huáxuě 247  
 dànbēi 65, 137  
 dàndǎ 230  
 dànfēn 151  
 dàng 237  
 dàngàng 235  
 dàngāo 140  
 dàngāo biāohuàdài 69  
 dàngāo kǎomù 69  
 dàngāo zhizuò 69  
 dàngfēng bóli qǐngxǐjī róngqǐ 202  
 dànghuóbǎn 63  
 dàngnǐbān 205  
 dàngguǐlièchē 208  
 dànhángdào 298  
 dànhuáng 137, 157  
 dànhuángguǎn 257  
 dànhuángjiàng 135  
 dānjià 94  
 dānjǐngtóu fǎngguāngzhàoxiàngjī 270  
 dànkè 137  
 dānmài 316  
 dànnǎigāo 140  
 dànnǎisù 158  
 dānpiàn sānmíngzhì 155  
 dānrén bǐngfáng 48  
 dānrén láofáng 94  
 dānrénchuáng 71  
 dānrénjiàn 100  
 dānrénláofáng 181  
 dànsuǐ chuidiào 245  
 dānxiāngshuǐ 41  
 dānxíng 194  
 dào...lǐ 320  
 dào...qù 320  
 dàocǎorén 184  
 dàochē 195  
 dàochéngshùhuàng 159  
 dàodài 269  
 dàodàn 211
- dàogōu 244  
 dàoguǎn 53  
 dàolù 194  
 dàolù jiāochāchūde huánxínglù 195  
 dàolùshìgōng 187, 195  
 dàoniqǐ 68  
 dàopiàn 66  
 dàoxiànqǐ 276  
 dàoyān 254  
 dàoyōu 260  
 dàoyù 282  
 dàpò jǐlù 234  
 dàqǐcéng 282, 286  
 dàqǐúxiàn 233  
 dǎshuǐ 239  
 dàsuàn 125, 132  
 dàtǐng 100, 104, 255  
 dàtǐqin 256  
 dàtǒuzhēn 276  
 dàtù 12, 119  
 dàxǐ yang 312  
 dàxínggāojī jiàochē 199  
 dàxíngxīng 291  
 dàxué 299  
 dàxuēshēng 169  
 dàyáng 282  
 dàyángzhōu 319  
 dàyīn 172  
 dàyīnjī 172, 176  
 dàzhǐ 15  
 defēn 228, 273  
 defēnqū 221  
 déguó 316  
 dēng 62  
 dēngjībù 100  
 dēngjīmènghào 213  
 dēngjīpái 213  
 dēngjītóngdào 212  
 dēngjiù 105  
 dēnglongguǒ 128  
 dēnglù 177  
 dēngpào 60  
 dēngpào jièkǒu 60  
 dēngshì 165  
 dēngsī 165  
 dēngtà 207  
 dēngtǎ 217  
 dēngtuǐ 250  
 dēngxīncǎo 86  
 dēngyú 165  
 dēngyuécāng 281  
 dǐ 164  
 dǐ 321  
 dǐ'èr 309  
 dǐ'èrshí 309  
 diǎn 273  
 diàn 60  
 diànbào 98  
 diànbào 60  
 diāncài 153  
 diànchàngjī 268  
 diànchí 167, 202, 260  
 diànchíhé 78  
 diàndòng tǐxùdào 73  
 diàndù 79  
 diàngōng 188  
 diànhuà 99, 172
- diànhuàhào máchǎxúntái 99  
 diànhuàtǐng 99  
 diānhuò 200, 266  
 diānhuòdǐngshí 203  
 diānjī 46  
 diānjiān 35  
 diānjità 258  
 diānlǎn 79  
 diànli 60  
 diānlícéng 286  
 diànlijīchē 208  
 diànnèi yòngcān 154  
 diānnuǎnqǐ 60  
 diànqǐngsè 274  
 diànqǐshí 288  
 diànqióu 227  
 diànquān 61, 80  
 diǎnrèn 71  
 diànshì liánxùjǐ 178  
 diànshì yǎnbōshì 178  
 diànshuǐhú 66  
 diǎntǐ 59, 100, 104  
 diànxiàn 60  
 diànxiàn 44  
 diànyǎ 60  
 diànyǐng fǎngyǐngtǐng 255  
 diànyǐngbǔjǐng 179  
 diànyǐngyuán 255, 299  
 diànyuánxiàn 176  
 diànyuánxiàng yánchángxiàn 78  
 diānzǐ 54, 235  
 diānzǐ chànpǐn 105  
 diǎnzǐqin 258  
 diǎnzǐyóujiàn 177  
 diǎnzǐyóujiàn dìzhǐ 177  
 diǎnzǐyóujiàn zhànghù 177  
 diànzuàn 78  
 diàochá 94  
 diào chuáng 266  
 diàogāoqiú 231  
 diàogōu 187  
 diàohuán 235  
 diàojuǐ 245  
 diàojuǐxiāng 244  
 diào kè 79, 275  
 diàolán 84, 95  
 diàorougōu 118  
 diàoshòuyīnjī 269  
 diào sùjiǎ 191  
 diào wǎdài 35  
 diào yù 244  
 diào yù 120  
 diào yù xūkèzhèng 245  
 diào yù zhē 244  
 dìbā 309  
 dìbǎn 62, 71  
 dìbāshí 309  
 dìbèi zhīwù 87  
 dìbiànyīngyuándé 41  
 dīcéng 141  
 dídǎ 213  
 didài 283  
 diding 266  
 diédòng 239  
 dīguǎn 109, 167  
 dǐjī 109  
 dǐjiào 183
- dijū 309  
 dijūshí 309  
 dilí 162  
 diliù 309  
 dilūshí 309  
 dilòu 72  
 dimàn 282  
 dimào 284  
 ding 79, 90  
 dīngcéng 141  
 dīngdiǎn 164  
 dīngjǐpiào 212  
 dīnggrén 227  
 dīngshūding 173  
 dīngshūjī 173  
 dīngxiāng 133  
 dīngxíng 38  
 dīngxíngshuǐ 38  
 dīngyíng 257  
 dīngzhēn 276  
 dīngzǐ 80  
 dīngzǐgāo 187  
 dīngzǐtóu 80  
 dipán 203  
 dipiān 271  
 diqī 309  
 diqī 83  
 diào 282  
 diqǐshí 309  
 diqióu 280, 282  
 diqū 315  
 disān 309  
 disānshí 309  
 dishí 309  
 dishìbā 309  
 dishìèr 309  
 dishìjū 309  
 dishìlǐ 309  
 dishìqǐ 309  
 dishìsān 309  
 dishìsì 309  
 dishìwù 309  
 dishìyí 309  
 disì 309  
 dishìshí 309  
 disòng 98  
 ditān 63, 71  
 ditǐ 208  
 ditǐ xiànlùtù 209  
 ditù 195, 261  
 ditù 91  
 diwú 309  
 diwúshí 309  
 dixiàn 226, 230  
 dixiàshí 58  
 diyǎ dàikuǎn 96  
 diyǐ 309, 320  
 diyǐbāi 309  
 diyīn dānhuángguǎn 257  
 diyīn jità 258  
 diyīn jitàshòu 258  
 diyīn pǔhào 256  
 diyīntǐqin 256  
 diyù 315  
 diyù biāozhǔn gānshù 233  
 dizhèn 283  
 dizhǐ 98  
 dizhōng hǎi 313

- dōng 312  
dōngdiwēn 319  
dōnghuàpiān 178, 255  
dōngji liǎngxiàng 247  
dōngji yúndòng 247  
dònglì huáxiàngjī 211  
dòngmài 19  
dōngnánguā 125  
dōngqingshù 296  
dōngsuānnái 137  
dōngtiān 31, 307  
dòngwù 290, 292, 294  
dòngwùxué 169  
dòngwùyuán 262  
dòngzuo 227, 229, 233, 237  
dòubàncài 123  
dòujià 122  
dòulèi 131  
dòuyá 122  
dú 162  
duǎn 32  
duǎnbīng sàozhou 77  
duǎnbō 179  
duǎnchènku 33  
duǎndài 27, 111, 141  
duǎndí 257  
duǎnfā 39  
duǎnkǒu 176  
duǎnkù 30, 33  
duǎnliàn 250  
duǎnpāibìqiú 231  
duǎnpào xuānshóu 234  
duǎnshù 296  
duǎntú xiàochē 232  
duǎnwén'è 293  
duǎnxiàn 99  
dǔchǎng 261  
dùchuán 215, 216  
dùchuán mǎtóu 216  
dùdài 242  
dúdòngzhùzhái 58  
duifāng fúfèi diànhuà 99  
duiféi 88  
duijiāngqī 59  
duijiāoxiàn 164  
duiliúcéng 286  
duiliúshì diànnuǎnqì 60  
duishǒu 236  
duixiàn 97  
duiyuánxí 229  
dùliàng 165  
dùliánghéng 310  
dùlìshì 58  
dùlún shòutuíchē 88  
dùmùzhōu 214, 241  
dūn 310  
dùncài 158  
dūnqì 250  
duò 241  
duòbǐng 240  
duòfēng 286  
duògē 317  
duòmínjījià 314  
duòmínikè 314  
duòmínuò gǔpái 273  
duòniánshēng (zhìwù) 86  
duòxiàngguó 132  
duóyún 286
- duōzhī 127  
duōzhōng wéishēngsù zhìjī 109  
dùqì 12  
dùsōngzìjū 145  
dùzhù 273  
DVD bōfāngjī 268  
DVD guāngpán 268
- E**  
é 119, 293, 295  
è 64  
édàn 137  
èguāduō'ěr 315  
ei 273  
éjī 16  
èlǐ 128  
èlìtēiyà 317  
éluósīliánbāng 318  
ènkòu 30  
èr 308  
ěr 244  
ěrbǎi 308  
ěrbīhòukè 49  
èrcéng 104  
ěrduò 14  
ěrhuán 36  
ěrjī 268  
èrkē 49  
èrlóu tīngzuò 254  
èrmiánshēng (zhìwù) 86  
èrshí 308  
èrshí fēngzhōng 304  
értóng 23, 31  
értóng ānquánsuǒ 75  
értóng bǎonuǎnkù 31  
értóng bìngfāng 48  
értóng fāngxuēzhuāng 30  
értóng shuǐyī 31  
értóng tàocǎn 153  
értóng xīshuǐchí 263  
értóng yòngpǐnbù 104  
értóngzuyǐ 198, 207  
èrtóujī 16  
èrtóujī xùnlìan 250  
èrxí 22  
èryuè 306  
érzǐ 22  
èxin 44  
èyú 293  
èyújià 167
- F**  
fáchūchǎngwài 223  
fādài 39  
fādiànqì 60, 207  
fādiànqióu 223  
fādòngjī 202  
fāgēn 39  
fāgū 38  
fāguān 180  
fāguó 316  
fājī 39  
fājìanlǎn 172  
fājū 38  
fājū 139  
fājū 169, 180  
fālùshìwùbù 175  
fālùzìxún 180
- fāmǎ 166  
fān 241  
fānbǎn 241  
fānbǎn yúndòng 241  
fānbǎn yúndòngyuán 241  
fāncài 64  
fānchuán 215, 240  
fānchuán yúndòng 240  
fāndìgāng 316  
fāndòukǎchē 187  
fāngbiàn shípín 107  
fāngbōdì 217  
fāngchénbù 83  
fāngdà 172, 271  
fāngdào jǐngbào 58  
fāngdìchǎnshāng 115, 189  
fāngdōng 58  
fāngdōngyè 199  
fāngfēng shéng 266  
fāngfēngjiákè 33  
fāngfēngjīng 265  
fāngfújī 83  
fānggé 272  
fānghùmiànqū 225, 228, 236  
fānghùpán 88  
fāngjiān 58, 100  
fāngjiàn dǎngbǎn 66  
fāngjiān hàomǎ 100  
fāngjiān sòngcǎn fúwù 101  
fāngjiān yàoshì 100  
fāngjiēshì 289  
fāngkè 58  
fāngkuài 273  
fāngshàishuāng 108  
fāngshāiyè 108, 265  
fāngshàiyóu 265  
fāngshèkè 49  
fāngshēng 245  
fāngshù 220  
fāngshòuduiyuán 223  
fāngshòuqū 224  
fāngshuikǒu 244  
fāngsōng 55  
fāngsuǎng jiāndài 205  
fāngsuǎngbǎn 204  
fāngsuǎngjīng 207  
fānguí 223, 226  
fāngwǔ 58  
fāngxiāng liǎofǎ 55  
fāngxiàngduò 210  
fāngxiàngpán 201  
fāngyǎngde 118  
fāngyǔzhào 266  
fāngzhī 277  
fāngzhuànghùlǎn 195  
fāngzú 58  
fānhéng 240  
fānjiāosuǒ 241  
fānjīndǒu 235  
fānlǎn 215, 240  
fānlǐng 32  
fānmùguā 128  
fānqié 125, 157  
fānqiéjiāng 135, 154  
fānqiézhǐ 144, 149  
fānshèjīng 167  
fānshìliú 128  
fānshǒu 231
- fánzào 25  
fánzujūlǐ 181  
fāpái 273  
fāqī 139  
fāqià 38  
fāqiú 231  
fāqiúdèfēn 230  
fāqiúfāng zhànxiān 230  
fāqiúqū 223  
fāqiúqū 232  
fāqiúshìwù 230  
fāqiúxiàn 226  
fāqiúxiàn 230  
fāsè 39  
fāshào 44  
fāshāo fēnchà 39  
fāshè 281  
fāshèjià 281  
fāshì huayuán 84, 262  
fāshì jièmojiàng 135  
fāshì pántóu 39  
fāshìtúsi 157  
fāshù 38  
fāshù guiyànà 315  
fāshuà 38  
fāsòng 177  
fātīng 180  
fāxing 39  
fèi 18  
fèibiāo 273  
féichángjī 16  
féikè 17  
fèiji 319  
fèiji 210  
fèilào 91  
féiliàoduī 85  
féilǔbin 319  
féiròu 119  
féishuǐzhǔ 67  
fèitānsuān 144  
féixíng 211  
féixíngyuán 190, 211  
féiyuēguò 128  
féizào 73  
féizàohé 73  
féizàojiù 178  
féizhīlǒu 172  
féizhōu 317  
féizhōujú 110  
fēnbǐ 162  
fēnbǐng 40  
fēnbù 175  
fēncānchí 68  
fēndào 234  
fēndí 40  
fēng 277  
fēng 241, 286  
fēngdǎng 198, 205  
fēngyè 173  
fēnggān 159  
fēnggānde 143  
fēnghé 52  
fēnghéxiàn 34  
fēngmào 31  
fēngniǎo 292  
fēngōngsī 175  
fēngrèn yòngpǐn 105  
fēngrenjī 276
- fēngshàn 60, 202  
fēngshànpidài 203  
fēngshù 296  
fēngshuǐ 55  
fēngtángjiāng 134  
fēngtángjīnpào 159  
fēngzuàn 187  
fēnhé 40  
fēnhóngsè 274  
fēnlán 316  
fēnlèijià 100  
fēnlèixiāng 61  
fēnmiàn 52, 53  
fēnmù 165  
fēnnù 25  
fēnpǔ 40  
fēnshù 165, 220  
fēnshuà 82  
fēnzhèn 304  
fēnzhōng 304  
fēnzǐ 165  
fū 12, 165  
fúbǎn 238  
fúbiāo 217, 244  
fúdiào jiàoshì 54  
fúgǔgōu 12  
fúhújié 27  
fúji 167  
fúji 16  
fújiàn 177  
fújiāshìyuán 211  
fúkè 49  
fúkè yishēng 52  
fúkèlǎn qúndào 315  
fukuān 96  
fùmǔ 23  
fùnǚ bǎojiàn 108  
fúpénzǐ 127  
fúpénzǐjiàng 134  
fúpimìanbào 139  
fúqiáng 301  
fúqīn 22  
fúqiú 61  
fūsè 41  
fūsè jiàoshēn 41  
fúshǐ 73, 288  
fúshǐ chēdào 195  
fúshǒu 59, 196, 200, 210  
fúshōuyí 63  
fúshǔ jiànzhùwù 182  
fúshuǐqióu 265  
fúsùshù 47  
fútèjiājiù 145  
fútiào 207  
fúwòchéng 250  
fúwú 94  
fúwùchē 212  
fúwùqì 176  
fúwùshāng 177  
fúxiào 305  
fúxié 44, 109  
fúyī 210  
fúyīn 172  
fúzhàng 153  
fúzhōng yàodài 239  
fúzhuāng 205  
fúzuòyòng 109



- G  
 gài 109  
 gàizi 61, 66  
 gǎi 158  
 gǎilífēn 132  
 gǎn 67  
 gǎn 245  
 gǎn'ēnjiē 27  
 gāncǎo 184  
 gāncǎotáng 113  
 gānchuanwú 217  
 gāngà 25  
 gāngbǐ 163  
 gāngbiyà 317  
 gāngguó 317  
 gāngguó mínzhǔ gònghéguó 317  
 gāngjū 81  
 gāngkǒu 214, 216, 217  
 gangling hénggān 250  
 gāngqín 256  
 gāngsīqián 80  
 gāngsīróng 81  
 gāngsuǒ 129, 156  
 gāngsuǒ 166  
 gāngwú jūzhǎng 217  
 gānhuà 111  
 gānjīng 321  
 gānjīng yīwù 76  
 gānjú 126  
 gānjúlèishuǐguó 126  
 gǎnlǎn 151  
 gǎnlǎnqíu 220  
 gǎnlǎnqíu qiúyí 221  
 gǎnlǎnyóu 134  
 gǎnlào dàngāomú 69  
 gǎnmào 44  
 gǎnmiànzhàng 69  
 gǎnxidiàn 115  
 gǎnxīng (pífū) 41  
 gǎnzàng 18, 118  
 gǎnzào 130, 286, 321  
 gǎnzhè 184  
 gāo 165, 321  
 gāo'ěrfū qiúchǎng 232  
 gāo'ěrfū qiúchē 233  
 gāo'ěrfū qiúdài 233  
 gāo'ěrfū qiúgān 233  
 gāo'ěrfū qiúxié 233  
 gāo'ěrfū qiúyuán 232  
 gāo'ěrfūqiú 232, 233  
 gāobāozhēn yīnxiǎng xītǒng 268  
 gāodà 321  
 gāodēngyuànxiào 168  
 gāodēngzhuānkē xuéxiào 169  
 gāodiàn 140  
 gāodiàndiàn 114  
 gāodīgàng 235  
 gāodù 211  
 gāogēnxié 37  
 gāojià qiáoxià tóngdào 194  
 gāojiǎoyí 75  
 gāojīnmìanfēn 139  
 gāomǎnào 289  
 gāoshān huàxué 247  
 gāoshān sùjiàng 247  
 gāoshān zhīwú 87  
 gāosùgōnglù 194  
 gāosùlièchē 208  
 gāotái tiàoshuǐ 239  
 gāowán 21  
 gāoyángrou 118  
 gāoyīn pùhào 256  
 gāoyū biāozhǔn gānshù 233  
 gāoyuán 284  
 gāozhīfángnǎiyóu 137  
 gēbān 67, 210  
 gēcǎo 90  
 gēcǎoji 90  
 gēcí 259  
 gédébùyùndòng 236  
 gējià 66, 268  
 gējū 255  
 gélí 121  
 gélídài 194  
 gélinglǎn 314  
 gélinnàdà 314  
 gélóu 58  
 gēlǔjīyà 318  
 gēlúnbiyà 315  
 gēlǔzǐ 131  
 gēmi 258  
 gēn 124, 296  
 gēngchà 321  
 gēnghào 321  
 gēnghuàn lǔntái 203  
 gēngyīshi 104  
 gēnjiàn 16  
 gēqū 259  
 gērécéng 61  
 gēshāng 46  
 gēshi wénjiànjià 173  
 gēshǒu 191  
 gēsīdǎlǐjià 314  
 gētèshi 301  
 gēzi 292  
 gōng 289, 301  
 gōng 249  
 gōngchǎng 299  
 gōngchéngxué 169  
 gōngdiàn xītǒng 60  
 gōnggāolán 173  
 gōnggōngqīchē 196  
 gōnggōngqīchē sījī 190  
 gōnggōngqīchē zǒngzhàn 197  
 gōnggōngqīchēpiào 197  
 gōnggōngqīchēzhàn 197, 299  
 gōnggū 17  
 gōngguó 315  
 gōngjī 94, 185  
 gōngjiàn bù yātú 250  
 gōngjīxiànlùhào 196  
 gōngjiù 187  
 gōngjùdào 80  
 gōngjùjià 78  
 gōngjùlǎn 177  
 gōngjùxiāng 80  
 gōngjùyàodài 186  
 gōnglǐ 310  
 gōnglǐ fàngdàqì 268  
 gōnglǔchē 206  
 gōngmén 85  
 gōngnèibìyùncì 21  
 gōngniú 185  
 gōngqīchē hòuchēting 197  
 gōngshuǐguǎn 61  
 gōngsī 175  
 gōngsù 180  
 gōngsuǒ 52  
 gōngwénbào 37  
 gōngxīng yuánding 300  
 gōngyèqū 299  
 gōngyidào 82  
 gōngyīmèishù 274, 276  
 gōngyīng sāncǎn 101  
 gōngyù 59  
 gōngyuán 262  
 gōngyùlǒu 59, 298  
 gōngzhuāngkù 30, 83  
 gōngzīdān 175  
 gōngzuò 172  
 gōngzuòjiàn 78  
 gōngzuòrì 306  
 gōngzuòtái 78  
 gōngzuòwūcān 175  
 gōu 290  
 gōulǎ xuéqiāo 247  
 gōuwú 104  
 gōuwú zhīnán 104  
 gōuwúchē 106  
 gōuwúdài 106  
 gōuwùlǎn 106  
 gōuwùzhōngxīn 104  
 gōuyàn 244  
 gōuzhēn 277  
 gōuzhī 277  
 gǔ 17, 258  
 guāchǎn 68  
 guāchū 77  
 guādao 82, 167, 275  
 guāhào yóujiàn 98  
 guān 145, 292, 311  
 guān 321  
 guāndào zhuāngzhì 61  
 guāndiànshì 269  
 guàngài 183  
 guāngbō 179  
 guāngbōdiàntái 179  
 guāngchǎng 299  
 guānggào 269  
 guānggào yánliào 274  
 guānggòupíng 134, 311  
 guāngguān tiáojiéhuàn 270  
 guāngguāng 260  
 guāngguāngbāshì 260  
 guānjié 17  
 guànlán 227  
 guānmén 260  
 guānmù xiūjiàn 87  
 guānnǎiyóu 137  
 guānniào 263  
 guānshāng (zhīwú) 87  
 guàntóuhé 311  
 guānyú 320  
 guānzhòng 233, 254  
 guànzhuāng shípín 107  
 guànzhuāng shuǐguó 135  
 guànzhuāng yīnliào 154  
 guāpí 127  
 guāràng 127  
 guàtújià 174  
 guāzǐ 127  
 gǔbā 314  
 gǔcāng 182  
 gǔdiǎn yīnyuè 255, 259  
 gǔdingluómǔ 203  
 gǔdòngdiàn 114  
 gǔfēn 97  
 gǔfēn 88  
 gǔfú 22  
 gǔgé 17  
 gǔgú 17  
 guì 321  
 guī 293  
 guǐdào 209, 280  
 guīkē 293  
 guīpí 133  
 guítai 96, 98, 100, 142  
 guīyànà 315  
 guīyú 120  
 gǔjī 261  
 gǔkē 38, 104, 106  
 gǔlèishípín 130, 156  
 gǔlǐ 130  
 gǔmā 22  
 gǔmǐ 130  
 gǔndòngtiáo 177  
 gǔntǒngshì hōnggānjī 76  
 gǔnzhōu liúbīng 263  
 gǔnzimianbào 138  
 guòdao 106, 254  
 guōgài 69  
 guōjī hángxiàn 212  
 guōjià 315  
 guōjiāgōngyuán 261  
 guōjiàng 156  
 guōjiàngbīng 142  
 guōjitiàoqì 272  
 guōjixiàngqì 272  
 guōlán 126  
 guōliáng 186  
 guōlíng 232  
 guōlù 61  
 guōlùshì kāfēi 148  
 guōmín 44  
 guōnèi hángxiàn 212  
 guōrén 122, 129  
 guōrén qiàokèlì cuībīng 141  
 guōròu 124, 127, 129  
 guōshānchē 262  
 guōwèisuānnǎi 157  
 guōwèixiàngpitāng 113  
 guōyuán 183  
 guōzhī 149, 156  
 guōzhī bīnggāo 141  
 gǔpén 17  
 gǔpiào jiàgè 97  
 gǔpiào jīngjīrén 97  
 gǔquán 97  
 gǔshìpiàn 269  
 gǔshǒu 258  
 gǔtǐfēngmǐ 134  
 gǔtōu 119, 121  
 gǔwèn 55  
 gǔwú 130  
 gǔxī 97  
 gǔyuán 24  
 gǔzhàng 203  
 gǔzhānghècǎi 255  
 gǔzhé 46  
 gǔzhīhuán 89  
 gǔzhǔ 24  
 H  
 hái 264, 282  
 hái'an 285  
 hái'an jīngwèidui 217  
 hái'ou 292  
 hàibào 255, 290  
 hàibīn bùdào 265  
 hàibīn yóuyōngdài 264  
 hái'di 314  
 hái'guān 212, 216  
 hái'guī 293  
 hái'lánbāoshì 288  
 hái'làng 264  
 hái'lù 120  
 hái'mǎ 294  
 hái'mián 73, 74, 83  
 hái'miáncéng 126  
 hái'shǐ 290  
 hái'tān 264  
 hái'tān xiǎowú 264  
 hái'tān yǔjīn 265  
 hái'tūn 290  
 hái'wángxīng 280  
 hái'xiàn 121  
 hái'xiàng 290  
 hái'xing 295  
 hái'yáng bǔlǎo 245  
 hái'zi 23  
 hán jiūjīng yīnliào 145  
 hánbǎobào 154, 155  
 hánbǎotàocǎn 154  
 hángbǎnhào 212  
 hángfēng 277  
 hángkōng mùjiàn 215  
 hángkōng yóujiàn 98  
 hángtiān fēiji 281  
 hángwú 318  
 hángxíng 240  
 hánjiē 79  
 hánqiān 199  
 hánxī 79, 81  
 hánzhàn 44  
 hào 321  
 háogōu 300  
 hàokàn 321  
 hàokè 310  
 háomí 310  
 hàoqiú 228  
 háoshēng 311  
 hasàkēsītān 318  
 hé 127  
 hé 292  
 hé'àn 284  
 hé'ěrméng 20  
 héchéngde 31  
 hégú 17  
 hégūxiàn 89  
 hèiàn 321  
 hèibǎn 162  
 hèicùlì 127  
 hèidài 237  
 hèidòng 280  
 hèifùshuāng 41  
 hèigǎnlǎn 143  
 hèigé 272  
 hèihǎi 313  
 hèikāfēi 148  
 hèimàimìanfēn 138

- hēiméi 127  
 hēimiànbào 138, 139, 149  
 hēiqiāokèlì 113  
 hēisāigēwéinà 316  
 hēisè 39, 274, 321  
 hēishān 316  
 hēitáo 273  
 hēixiànxuě 120  
 hēiyāndòu 131  
 hēiyàoyán 288  
 hēiyù 288  
 hēkà 27  
 hékǒu 285  
 hélán 316  
 héliú 284  
 hémǎ 291  
 hēnduǒ 320  
 hénggān 235  
 hénggāng 250  
 hénggémó 19  
 héngliáng 207  
 héngzuò'ān 242  
 hēnshāo 320  
 héqidào 236  
 hēsè 274  
 hēsèxiāobiāndòu 131  
 hēshì cidàiluyīnjī 269  
 hēshì lùyīndài 269  
 hēshì wénjiānjiā 173  
 hétào 129  
 hétaoyóu 134  
 hóng(pútáojiǔ) 145  
 hóngbāoshì 288  
 hóngchá 149  
 hóngcūlì 127  
 hóngdòu 131  
 hóngdūlāsī 314  
 hóngghǎi 313  
 hóngghèsè 39  
 hóngghuācǎidòu 122  
 hóngkǎo càiyáopán 199  
 hóngkǎo shípín 107  
 hóngkǎode 129  
 hóngmó 51  
 hóngpái 223  
 hóngqiújiǔjù 123  
 hóngròu 118  
 hóngsè 274  
 hóngshǔ 125  
 hóngshuǐ 287  
 hóngxīn 273  
 hóngyán 271  
 hóngyù 294  
 hóngyúndòu 131  
 hóngzhāji 211  
 hóngzhì 67, 138, 159  
 hóngzōngsè 39  
 hóngzūnyù 120  
 hòu 272, 321  
 hòudixié 37  
 hòujiābǎn 214  
 hòujìdàtīng 213  
 hòujié 19  
 hòujīlòu 12  
 hòujīng 13  
 hòulún 197  
 hòutiān 307  
 hòutóu 19  
 hòutūròu 119  
 hòuzhēnshì 45  
 hóuzi 291  
 hòuzuò 200, 204  
 hú 164, 285  
 hǔ 291  
 huà 62, 162, 274  
 huā 110, 297  
 huā'è 297  
 huábǎn 249, 263  
 huábàn 297  
 huábàn yúndòng 249  
 huābào 111  
 huàbì 274  
 huābiān 35  
 huàbù 274  
 huáchuán 241  
 huáchuánji 250  
 huádián 110  
 huáfēn 276  
 huáfúbǐng 157  
 huāgāngyán 288  
 huāgépíng 84  
 huāguān 111  
 huáhánbǐng 249  
 huāhuán 111  
 huài 321  
 huàiyùn 20, 52  
 huàiyúnde 52  
 huàiyúnsāngēyuè 52  
 huàjī 99  
 huàjià 274  
 huàjiā 191, 274  
 huàjiān 249  
 huàjiāngchuán 214  
 huàkuàng 62  
 huālěi 229  
 huālěi 297  
 huàn píndào 269  
 huànchéng 209  
 huàndēngjī 163, 174  
 huàngfēng 295  
 huàngǎidí 120  
 huànguā 125  
 huànghūn 305  
 huàngpái 223  
 huàngsè 274  
 huàngshuǐxiān 111  
 huàngyóu 137, 156  
 huàngyù 288  
 huánjīng 280  
 huànrén 223  
 huànshūriqī 168  
 huànxióng 290  
 huànyidiàn 74  
 huànzhè 45  
 huāpén 89  
 huāpíng 63, 111  
 huāshāng 188  
 huāshèng 129, 151  
 huāshèngjiàng 135  
 huāshèngyóu 135  
 huāshìqīshù 243  
 huàshù 296  
 huāshù 35, 111  
 huāshuǐ 239, 241  
 huāshuǐqiāo 241  
 huāshuǐzhè 241  
 huātán 85, 90  
 huátí 263  
 huàtóng 179  
 huáxiáng 248  
 huáxiángjī 211, 248  
 huáxiángsǎn 248  
 huáxing 224  
 huàxuě 246  
 huàxuě 162  
 huàxuě pódào 246  
 huàxuěbǎn 246  
 huàxuěfú 246  
 huàxuějǐng 247  
 huàxuěshān 31, 33  
 huàxuěxiè 246  
 huàxuězhàng 246  
 huàxuězhè 246  
 huāyàng 83  
 huāyàng huábīng 247  
 huāyàng yóuyóng 239  
 huāyēcài 124  
 huāyuan 84  
 huāyuán zhuāngshì 84  
 huāyuánfēnggē 84  
 huāyuánzhìwù 86  
 huàzhuāng 40  
 huàzhuāngjīng 40  
 huàzhuāngpǐn 107  
 huàzhuāngshuā 40  
 hùchǐ 237  
 hùdié 295  
 hùfāsù 38  
 hui 293  
 huídà 163  
 huīgān 232  
 huíhè 230, 237  
 huìhuà 261, 274  
 huíjiāng 187  
 huílù 97  
 huipào 98  
 huíqiú 231  
 huísè 39, 274  
 huishòuzhàn 177  
 huísuǒ 232  
 huíwéi 280  
 huíxiāng 122, 133  
 huíxiāngzǐ 133  
 huíxing 280  
 huíyān 19  
 huíyì 174  
 huíyìjìlù 174  
 huíyìshì 174  
 huìzhāng 189  
 hùjiān 224  
 hùjiào ànniù 48  
 hùjiāofēn 64, 152  
 hùjiāoli 132  
 hùkūi 236  
 húlì 290  
 hùlǐ 91  
 hùliánwǎng 177  
 hùlubá 132  
 húlúobo 124  
 hùmùjīng 81, 167  
 hūnjúé 44  
 hūnlǐ 26, 35  
 hūnlǐ dāngāo 141  
 hūnnìngtǔkuài 187  
 hūnyàn 26  
 hūnyīntái 179  
 huòbì 97  
 huòbì miànè 97  
 huòcāng 215  
 huòchá 112  
 huòchē 208  
 huòchéngyán 288  
 huòchētóu 208  
 huòchēzhàn 208  
 huòchuán 215  
 huòdòng 245, 263  
 huòdòng wánjù 74  
 huòdòngguàtú 174  
 huòhuāsāi 203  
 huòjī 119, 185, 293  
 huòjià 106  
 huòlièniào 292  
 huòlǐ 67  
 huómian 138  
 huòpángjiàn 16  
 huòqíncúkuǎn zhànghù 96  
 huòqíng 95  
 huòshān 283  
 huòshāndào 283  
 huòshānhuī 283  
 huòshānkǒu 283  
 huòtuī 119, 143, 156  
 huòtuīpiàn 119  
 huòwù 216  
 huòxiàn 280  
 huòxīng 60  
 huòyúlóng 244  
 huòzāi jīngbàoqì 95  
 hùshì 45, 48, 52, 189  
 hùtuī 225  
 hùwàihuòdòng 262  
 hùwàn 230  
 hùwéi 74  
 hùxī 205, 220, 227  
 hùxī 47  
 hùxītiàoqié qì 239  
 hùxīxitóng 19  
 hùzhào 213  
 hùzhào jiāncháchù 213  
 jiàkèlè lǎngmùjiǔ 151  
 jiàlāpàgēsī qúndào 315  
 jiàlèbì hǎi 312  
 jiālǐninggélè 316  
 jiālún 311  
 jiànbùbiào 154  
 jiàn 176, 249  
 jiàn 38, 165, 295  
 jiān 13, 36, 67, 122  
 jiàn 17  
 jiānà 317  
 jiānàdà 314  
 jiāncái 277  
 jiāncái kǎojiu 35  
 jiāncǎoji 88  
 jiāncǎoqì 88  
 jiānchá 49, 50  
 jiàndài 35, 249  
 jiāndàn 157  
 jiāndanbǐng 158  
 jiàndào 236  
 jiàndào 38, 47, 82, 188, 276  
 jiāndīng 300  
 jiāndīngshì 300  
 jiàng 143, 155  
 jiāng 241  
 jiāng 125, 133  
 jiāngguō 127, 296  
 jiānghào 256  
 jiānghuāngēn 132  
 jiāngjiēren 174  
 jiāngluòsǎn 248  
 jiāngpái 235  
 jiāngquán 112  
 jiāngshéng 242  
 jiāngshì 169  
 jiāngshǒu 241  
 jiāngsuǒ 129, 151  
 jiāngsuǒ 69  
 jiāngxuējīn 169  
 jiānhuìyì 53  
 jiānjiǔgū 17  
 jiànkāng 44  
 jiànkāngde 321  
 jiànkāngzhōngxīn 168  
 jiànlan 110  
 jiànpán 172, 176  
 jiānpàokou 209  
 jiānpiaoyuán 209  
 jiānpúzài 318  
 jiànshēn 250  
 jiànshēn qixiè 250  
 jiànshēnchē 250  
 jiànshēnfáng 101, 250  
 jiànxiè pēnquán 285  
 jiànxiūjīng 299  
 jiànyù 120, 294  
 jiānyù 181  
 jiānyùchǎn 68  
 jiànzhào 186  
 jiànzhèngqì 205  
 jiànzhì 159  
 jiànzhù 186, 300  
 jiànzhù cáiliào 187  
 jiànzhù fēnggē 301  
 jiànzhùgōngdì 186  
 jiànzhùgōngrén 186, 188  
 jiànzhùshì 190



- jiànzhùwù 299  
 jiānzúqián 80  
 jiào 12, 15, 164, 291  
 jiāo 275  
 jiāobàn 67, 138  
 jiāobànbàng 150  
 jiāobānqì 66  
 jiāobànróngqì 66  
 jiāobànwǎn 69  
 jiāobèi 15  
 jiāochā xunliànqì 250  
 jiāodà 67  
 jiāodàijià 173  
 jiāodēng 206  
 jiāodōng 67  
 jiāoguān 89  
 jiāohán 25  
 jiāohébān 79  
 jiāohòugēn 13, 15  
 jiāohuái 13, 15  
 jiāohuichū 194  
 jiāojiàn 271  
 jiàokēshù 163  
 jiāoliúdiàn 60  
 jiāoliúfadiànqì 203  
 jiāolóu 300  
 jiāomó 51  
 jiāomǔ 138  
 jiāonáng 109  
 jiāonàicè 15  
 jiāopiàn 260, 271  
 jiāopǔ 239  
 jiāoqi 223  
 jiāoqiāng 78  
 jiāoqiú 223  
 jiāoqū 299  
 jiàoshì 162  
 jiāoshǒujià 186  
 jiāoshuǐ 90  
 jiàotáng 299, 300  
 jiāotáng 113, 139  
 jiàotáng dànnǎi 141  
 jiàotōng 194  
 jiàotōng biāozhì 195  
 jiàotōng jīngchá 195  
 jiàotōng xīnhàodēng 194  
 jiàotōng yúnshū 194  
 jiàotōngdúsè 195  
 jiāoxiāngyuè 256  
 jiāoxīngwàikè 49  
 jiāoyōu 26  
 jiāozhàng 15  
 jiāozhǐ 15  
 jiāozhǐ 159  
 jiāopéng 317  
 jiáqián 78, 150, 166  
 jiáqiánzuò 166  
 jiáqiáochóng 295  
 jiārè yuánjiàn 61  
 jiàri 212  
 jiàri zhínán 212  
 jiàshàngpǐ 15  
 jiàshǐ 195  
 jiàshǐ 181  
 jiàshǐ 223  
 jiàshǐcāng 210  
 jiàshǐshì 95, 208  
 jiàshǐtái 214  
 jiàshǐxí 196  
 jiàshǐzuò 204  
 jiàshuǐ wèishìjì 151  
 jiàsùqì 200  
 jiàtīng 22  
 jiàtīng jiàochē 199  
 jiàtīng rìyǒngpīn 107  
 jiàtīngyúlè 268  
 jiàxiān 140  
 jiàxiānsù 140  
 jiàyà 50  
 jiàyīng 244  
 jiàyīng chuidiào 245  
 jiàyòng diànqì 107  
 jiàyòng fāngzhīpīn 105  
 jiàyòng yàoxiāng 72  
 jiàyóuchū 199  
 jiàyóuzhàn 199  
 jiàzhuàngxiàn 18  
 jiàzigǔ 258  
 jībǐjì 163  
 jībīng 44  
 jībùtí 317  
 jīcāng 210  
 jīchàng 212  
 jīchí 243  
 jīchí jiàozhèngqì 50  
 jīdǎ 237  
 jīdàn 137  
 jīdào (duìshǒu) 237  
 jīdì 282  
 jīdòng xuèqiāo 247  
 jiēbèishì jiàochē 199  
 jiēbēng 287  
 jiēcàizì 131  
 jiēchū 168  
 jiēchūguǐ 209  
 jiēdài zǒngtái 100  
 jiēdàiyuán 100, 190  
 jiēdào 298  
 jiēdi 60  
 jiēdiàn zhuāngzhì 266  
 jiēdòng 67  
 jiégǔ 49  
 jiéhùn 26  
 jiéhùn lífú 35  
 jiējǎo 298  
 jiékè 316  
 jièlì 235  
 jièlìbàng 235  
 jiémáo 14  
 jiémáogāo 40  
 jiémén 61  
 jiémànshuǐ 41  
 jièmo 155  
 jiémù 254, 269  
 jiémùbēi 269  
 jiémùbiānpái 178  
 jiémùzhūchírén 178  
 jiépài 259  
 jièpǎodào 167  
 jiéqing 27  
 jiéqiú 220, 225, 227, 229  
 jiéqīushǒu 229  
 jiérì 27  
 jiérìsītān 318  
 jièrù 168  
 jièshào 174  
 jiēshǒu 177  
 jiēshù 321  
 jiēshùchū 168  
 jiēshùzhèng 168  
 jiētījiāoshì 169  
 jiētīng diànhuà 99  
 jièwàiqì 228  
 jièxiànyuán 99  
 jièzhì 36  
 jièzhòng 45  
 jīfēng 287  
 jīfēnpái 225  
 jīfù 23  
 jīguāng 286  
 jīguāng chángpán 269  
 jīhè 165  
 jījīàn 249  
 jījīàohuái cháng 34  
 jījīé 307  
 jījì 47, 94  
 jījì rényuán 94  
 jījìxiāng 47  
 jīkuài 155  
 jīlàng tóudiào 245  
 jīliàng 109  
 jīliú 241, 284  
 jīlù 234  
 jīlùpiàn 178  
 jīmù 23  
 jīn 289  
 jīn'è 96  
 jīnbābùwéi 317  
 jīnbīāosài 230  
 jīng 12, 111, 290  
 jīngbāmìniǎnfēn 138  
 jīngchá 94, 189  
 jīngchájù 94  
 jīngcháng 320  
 jīngchē 94  
 jīngdēng 94  
 jīngdì 94  
 jīngdǔ 17  
 jīngguān 94  
 jīnggūn 94  
 jīnghuī 94  
 jīngjià 51  
 jīngjìcāng 211  
 jīngjìchāng 243  
 jīngjìxué 169  
 jīngkǒng 25  
 jīnglǐ 24, 174  
 jīngluán 44  
 jīngmài 19  
 jīngnáng 21  
 jīngōng 220  
 jīngōngqū 224  
 jīngpiàn 51  
 jīngshén liáofǎ 55  
 jīngshēnkè 49  
 jīngshēnpén 72  
 jīngshìdēng 201  
 jīngtóu 270  
 jīngtougài 270  
 jīngtuō 46  
 jīngxiān 283  
 jīngxiānpīn 255  
 jīngyà 25  
 jīngyóu 55  
 jīngzhuàngtǐ 51  
 jīngzhuī 17  
 jīngzì 63, 71  
 jīngzì 20  
 jīniànbēi 261  
 jīniànpīn 260  
 jīnjī chūkǒu 210  
 jīnjī qíngkuàng 46  
 jīnjī shāchēzhà 209  
 jīnjú 126  
 jīnpái 235  
 jīnpào 130  
 jīnqiāngyú 120  
 jīnqǐkǒu 61  
 jīnqǐdùfēn 223  
 jīnróng 97  
 jīnrúchǎnwù 217  
 jīnsè 39  
 jīnshēn nèiyī 35  
 jīnshēnyī 250  
 jīnshì 51  
 jīnshù 79, 289  
 jīnshù zuàntóu 80  
 jīnshùxiàn 79  
 jīnsīquè 292  
 jīntiān 306  
 jīnù 23  
 jīnwǎng duànqì 230  
 jīnxíng 280  
 jīnyānqū 152  
 jīnyú 294  
 jīnzhāng 25  
 jīpiào 213  
 jīpǔfǎ 256  
 jīqīāng 189  
 jīqiú 224, 225, 229, 233  
 jīqiúdòngzuò 231  
 jīqiújú 228  
 jīqiúshǒu 225, 228  
 jīqiúxiàn 225  
 jīqiúzìshì 232  
 jīròu 16  
 jīròu hànbaò 155  
 jīshè 185  
 jīshēn 210  
 jīshíqì 166  
 jīshù 165  
 jīsuànjī 172, 176  
 jīsuànqì 165  
 jītāshǒu 258  
 jīti zhǐliáo 55  
 jītóu 210  
 jì 321  
 jì 308  
 jìbā 150, 152  
 jìbā xiāochī 151  
 jìbǎi 308  
 jìbǎo 150, 191  
 jìbāyī 150  
 jìbēi 65  
 jìuchí 50  
 jìucōng 125  
 jìucù 135  
 jìudān 152  
 jìuhùchē 94  
 jìuhuò shāngdiàn 115  
 jìuqí 223  
 jìushēng liáowàngtǎ 265  
 jiùshēngfǎ 240  
 jiùshēngqǐjù 240  
 jiùshēngquān 240  
 jiùshēngtǐng 214  
 jiùshēngyī 240  
 jiùshēngyuán 239, 265  
 jùshǐ 308  
 jùwō 15  
 jùyè 26  
 jùyüè 306  
 jìwèijù 151  
 jìwèijù tiáozhìqì 150  
 jìxí cháng 34  
 jìxiè 187  
 jìxiègòuzào 202  
 jìxièshì 188, 203  
 jìxinrén dìzhì 98  
 jìyì 79  
 jìyì 210  
 jìyóu 273  
 jìyóuxiāng 204  
 jìzhè 179  
 jìzhèngshì 48  
 jìzhù ànmǒfǎ 54  
 jìzhuāngxiāng 216  
 jìzhuāngxiāng chuán 215  
 jìzhuāngxiāng gǎngkǒu 216  
 jìzhū 17  
 jìzì 23  
 jìzuò 99  
 jú 230  
 jú 79  
 juǎn 311  
 juǎnchǐ 80, 276  
 juǎnfǎ 39  
 juǎnfǎjiāzì 38  
 juǎnfǎqián 38  
 juǎnlián 63  
 juǎnxīncài 123  
 juǎnyángjī 214  
 júbānér 126  
 júbānér 126  
 júbēn 254  
 juélei zhìwù 86  
 juésè fēnpèi 254  
 juéshìyuè 259  
 juéyuán jiàodài 81  
 jùfēng 287  
 jùguāngdēng 259  
 júhuā 110  
 júhuāchá 149  
 jújù 122  
 júlǐ 310  
 jūnzhi 137  
 júsè 274  
 júyú 125  
 jùyuán 254, 299  
 jūzhǐ 277  
 jūzì 126  
 jūzì shuǐ 144  
 jūzìjiāng 134, 156  
 jūzìzhì 149  
 K  
 kābēndá(àngēlā) 187  
 kābōwèilèwù 237  
 kābūqīnùo kāfēi 148  
 kāchē sījī 190

- kāfēi 144, 148, 153, 156, 184  
kāfēi nàixī 149  
kāfēibēi 65  
kāfēichí 153  
kāfēidǒu 144  
kāfēiguǎn 148, 262  
kāfēihù 65  
kāfēiji 148, 150  
kāfēimò 144  
kāi 321  
kāidiànshì 269  
kāiguān 60  
kāiguānqǐ 68  
kāihuà guànmù 87  
kāimén 260  
kāipíngqǐ 68, 150  
kāiqiú 233  
kāiqiúqū 224  
kāishǐ 321  
kāisūnjiǔ 81  
kāitingri 180  
kāiwéide 155  
kāiwèijiǔ 153  
kāixíngqū 129  
kāimǎilóng 317  
kāiménbèi gānlào 142  
kāndiànshì 269  
kāngbiàn 180  
kāngnàixīn 110  
kāngzhòu 41  
kānpéilǐjiǔ 145  
kāodiàn 62  
kāojiàpán 69  
kāomiànǎo 157  
kāomiànǎoji 66  
kāopán 69  
kāoròu 158  
kāoròuchuàn 155, 158  
kāosānmíngzhǐ 149  
kāoshì 163  
kāoxiāng 66  
kāoxiāng shóutào 69  
kāozhì 67, 159  
kātà'ěr 318  
ké 129  
kè 163, 310  
kēcāng 214  
kéchēxiāng 208  
kēdiào bānshou 80  
kēdóu 294  
kèhù 96, 175  
kèhù fúwù 104  
kèhù fúwùbù 175  
kèhuànpiān 255  
kèhuò liàngyòngchē 199  
kei 273  
kèkèfēn 148  
kèlè 144  
kèlǐ jièmojiàng 135  
kèlǐzhuàng 132  
kèlúodiyà 316  
kémóluòqúndǎo 317  
kěnniyà 317  
kèrén 64, 100, 152  
kèróngjiède 109  
kèshì 49  
kèshidiànhuà 99  
késou 44
- kètèdīwá 317  
kèwèitè 318  
kèxíjiàdǎo 316  
kèxué 166  
kèxuèjiā 190  
kèyùn mǎtóu 216  
kèzhuō 162  
kiu 273  
kōng 321  
kōngbùpiān 255  
kōngchèng rényuán 210  
kōngfān 235  
kōnggào 94, 180  
kōngjiān zhàn 281  
kōngqìguòlùqǐ 202, 204  
kōngquè 293  
kōngqueshì 289  
kōngshòudào 236  
kōngtiáo 200  
kōngxian 321  
kōngzhìtā 212  
kōngzhìtái 269  
kōngzhōngxiàojiè 190  
kǒudài 32  
kǒuhóng 40  
kǒuhuán 37  
kǒuliànchǐ 207  
kǒuqiāng wèishēng 72  
kǒuqiāngguāng 50  
kǒuqiú 231  
kǒuxiāngtáng 113  
kǒuyǎn'ér 32  
kǒuzhào 189  
kú 124  
kū 25  
kuàbǎo 37  
kuài 311, 321  
kuàicān 154  
kuàicāndiàn 148, 154  
kuàigēnqín 124  
kuàijībù 175  
kuàijīn 269  
kuàijīshǐ 97, 190  
kuàijūn 125  
kuàilè 25  
kuàimén jiàn 270  
kuàimén sùdù tiáojiéniǔ 270  
kuàitǐng 214, 241  
kuàizhuàngqiàokèlibǎn 113  
kuàilán 235  
kuān 12, 165, 321  
kuángfēng 286  
kuánghuānjié 27  
kuàngquán shuǐ 144  
kuàngwǔ 289  
kuānpíng diànshì 269  
kuātuó 311  
kūcǎorè 44  
kuihuāzǐyóu 134  
kuíning dùsōngzǐjiǔ 151  
kuíning shuǐ 144  
kuínúyǎlǐ 130  
kǔjǔ 123  
kǔmíng 132  
kǔnbǎng xīsī 89  
kǔnbǎo 184  
kǔnhuò 25  
kǔnnán 321
- kuòxiōng 250  
kuòyinqǐ 209, 258  
kuòyǔ 295  
kuòzhāngshù 52  
kúpíjiǔ 145  
kùzǐ 32, 34
- L  
là 124  
làba 201, 204  
làgēncái 125  
làisúotūō 137  
lāji huǐshòuxiāng 51  
lājiao 124, 143  
lājiaofēng 132  
lājiaomò 132  
lājichǔlǐ 61  
lājītōng 61, 67  
lājixiāng 266  
lālādūichāng 220  
lāliàn 277  
làn 127  
lánbǎn 226  
lánbānqǐ 226  
lánbōshì 288  
lānchē 246  
lānchē diàoyǐ 246  
lāndiào yīnyuè 259  
láng 290  
lángān 74  
lànghuā 241  
lāngmǔjiǔ 145  
lánhuā 111  
lánjiǔqí 231  
lānméi 127  
lánqiú 226  
lánqǐu qiúyuán 226  
lánquān 226  
lānsè 274  
lānshéng 217  
lānwǎng 227  
lānwèi 18  
lānwénnàilào 136  
lào'ou 137  
lǎoshì 162, 190  
lǎoshìqìchē 199  
lǎoshù 290  
lǎotie 81  
lǎowō 318  
lǎtuōwéiyà 316  
lǎxiāngcháng 142  
lǎzhǐ 39  
lǎzhù 63  
léi 286  
léidá 214, 281  
léigài yīnyuè 259  
léigū 17  
lèijiānji 16  
lèipái 119, 155  
lèng 286, 321  
lèngdòng 67  
lèngdòng shípín 107  
lèngdòngde 121, 124  
lèngdòngshì 67  
lèngquèjì róngqǐ 202  
lèngquèjià 69  
lèngshuǐ lóngtóu 72  
lèngzhàoyǔ 135
- léngzhuǐtǐ 164  
lí 126, 183  
lí...yuán 320  
lián'ài 26  
liáng 186  
liángbēi 150, 151  
liángchǐ 109  
liángdiǎn zhōng 304  
liánggān 76  
liángghú 69, 311  
liángjiāoqǐ 165  
liángqǐ dòngwǔ 294  
liángwǎn 309  
liángxié 31, 37  
liàngyǐshéng 76  
liàngyóuji 202  
liángzhōu 307  
liánheshòuqǐ 182  
liánhuán 36  
liánhuánhuà 112  
liǎnjiá 14  
liǎnjié 177  
liánkǒu 36  
liánkùwà 34, 35  
liánpáishì 58  
liànpán 206  
liǎnrú 136  
liánsài 223  
liànshānkù 30  
liántóng 320  
liànxi huīgān 233  
liányǐqún 31, 34  
liányùn 212  
liánzi 36  
liba 85  
libānèn 318  
libǐliyà 317  
libìyà 317  
lièchē shíkèbiào 209  
lièchē zhōnglèi 208  
lièxi 293  
lièzhīdūnshìdēng 316  
lǐfāngtǐ 164  
lǐfāshǐ 39, 188  
lǐhǎi 313  
lǐhéqǐ 200, 204  
lǐhūn 26  
lǐjiāoqiáo 194  
lǐjiròu 119  
lǐkǒujiǔ 145  
lǐliàng xùnlǎnqǐ 250  
lǐliáokē 49  
lǐlù 96  
lǐmào 36  
lǐmí 310  
lǐn 293, 294  
lǐnbāxitōng 19  
lǐng 197, 308  
lǐngdài 32  
lǐngdàijià 36  
lǐngfēn 230  
lǐnggōu 276  
lǐnggōuhuán 276  
lǐnggǔ 257
- língjiāngtái 235  
língjié 36  
língkǒu 34  
língqǐ liáofā 55  
língqǐ xínglichù 213  
língshí 113  
língtǔ 315  
língxiàn 60  
língxing 164  
línjū 24  
línpiàn 121  
línpiàndao 299  
línynǚ 72  
línynǚ gélián 72  
línynǚ gémén 72  
línynǚ pēntóu 72  
lípái lixiàn xiàngjī 270  
lípíndiàn 114  
lishì 162  
lishì jiànzhù 261  
litàowǎn 316  
lǐtí 164  
lǐtiē 173  
lǐtíshèng 269  
lǐtí 308  
liùbāi 308  
liùbiānxíng 164  
liùbǐng 242  
liùchǎn 57  
liúgǎn 44  
liúhuáng 289  
liúlán 177  
liúlǎnqǐ 177  
liùshì 308  
liùshù 296  
liúsù huābiān 277  
liúxing 280  
liúxingyīnyuè 259  
liúxingyīnyuè jiémù zhǔchírén 179  
liúyán 100  
liúyue 306  
liúzuòxiāngshìchē 199  
liwù 27  
liyán 288  
liyǐzhù 26  
liyú 294  
lizhì 128  
lizi 129  
lizi 126  
lónggǔ 214  
lónghāo 133  
lóngjiǎnfēng 287  
lóngshélanjiǔ 145  
lóngtou 243  
lóngxiá 121, 295  
loubèizhuāng 35  
lǒucǎopá 88  
lǒucéng 58  
lǒudǒu 166  
lǒuhuā píxié 37  
lǒuhuājiǔ 78  
lǒujié 220  
lǒusháo 68  
lǒutí 59  
lǒutí lángān 59  
lǒutí ménlán 75  
lǒutí píngtái 59



lóuzuò 254  
 lù 291  
 lù 185  
 lù 289  
 luǎnchá 20  
 luǎnpào 20  
 luǎnzǐ 20  
 lùbāoshí 288  
 lùbiān kāfēizuò 148  
 lùbiāo 298  
 lùbō 178  
 lùcǎodài 85  
 lùchá 149  
 lùdēng 298  
 lùdi 282  
 lùdòu 131  
 lùgānlǎn 143  
 lùgú 17  
 lùguǎn 100, 264  
 lùguō 68  
 lùjiǎo 291  
 lùjīng 270  
 lùkè 208  
 lùmiànbiāozhì 194  
 lùngǔ 206  
 lùngǔgài 202  
 lùnhuáxíe 249  
 lùnjīcāng 214  
 lùnquān 206  
 lùntāi 198, 205, 206  
 lùntāi chōngqǐjī 199  
 lùntāi qiàogǎn 207  
 lùnwén 169  
 lùnyí 48  
 lùnzhóu 205  
 lùnzhóupídài 203  
 luó 257  
 luóbo 124  
 luógānméi 127  
 luòjǐ shānmài 312  
 luòkèkèshì 301  
 luólè 133  
 luómǎnlíyà 316  
 luómú 80  
 luòqíuqū 225  
 luósī dàotóu 80  
 luósīdào 80  
 luósīdǐng 80  
 luòtuó 291  
 luóxuánjiǎng 211, 214  
 luòyè (zhíwù) 86  
 luòyèsōng 296  
 lúpán 67  
 lùsè 274  
 lùsēnbào 316  
 lùsèshípíndiàn 115  
 lùshǐ 180, 190  
 lùshǐshíwùsù 180  
 lùsōngshí 289  
 lútí 61  
 lùtiān kāfēizuò 148  
 lùwǎng 68  
 lùwǎngdá 317  
 lùxiàngdài 269  
 lùxiàngjī 269  
 lùxíng lùxiàn 260  
 lùxíng tuōchē 266  
 lùxíng zhípào 97

lǔxíngchē 206  
 lǔxíngdài 37  
 lǔxíngdàilǐ 190  
 lǔxíngmótuō 205  
 lǔxíngshē 114  
 lǔxíngzhǐnán 260  
 lùyán 298  
 lùyīndiàoǎn 179  
 lùyīng 266  
 lùyīngdì 266  
 lùyīnshì 179  
 lùyīnshí 179  
 lǔyóu wènxúncù 261  
 lùzhì 269  
 lǔzhì 143  
 lǔzhì 167

## M

mǎ 185, 242, 272, 310  
 mǎ'èrdàifū 318  
 mǎ'èrtā 316  
 mǎān 242  
 mǎbiān 242  
 mǎbingláng 143  
 mǎbù 77  
 mǎdá 88  
 mǎdǎjiāsījī 317  
 mǎdèng 242  
 mǎèrwéināsi qúndǎo 315  
 mǎfú 243  
 mǎhuābiàn 39  
 mǎibó 47  
 mǎifū 130  
 mǎikèfēng 258  
 mǎipiànzhóu 157  
 mǎiyácu 135  
 mǎiyànyǐnlǎo 144  
 mǎjiǎ 33  
 mǎjiāozǐ 242  
 mǎjiū 185, 243  
 mǎjū 185  
 mǎkèbèi 65  
 mǎkù 242  
 mǎláixīyà 318  
 mǎlāsōng 234  
 mǎlāwéi 317  
 mǎlè 242  
 mǎlǐ 317  
 mǎlǐngshù 124  
 mǎn 321  
 mǎn 266, 321  
 mǎn 85, 209  
 mǎndiàn 59  
 mēnggū 318  
 mēngjiālǎguó 318  
 mēngqiègē gānlào 142  
 mēnhuán 59  
 mēnláng 58  
 mēnlángdēng 58  
 mēnliàn 59  
 mēnling 59  
 mēnshuān 59  
 mēnsuǒ 200  
 mēnting 59  
 mēnyá 50  
 mēnzhen bingren 48  
 mēnzhū 220, 222  
 mǐ 130, 310

miàn 164  
 miànbào 138, 157  
 miànbāodào 68  
 miànbāodiàn 114, 138  
 miànbāoguō 124  
 miànbāokuài 139  
 miànbāopi 139  
 miànbāoshí 139  
 miànbāoxiè 139  
 miànbèi 71  
 miànbù 277  
 miànshù 14  
 miànbùhǔlǐ 41  
 miǎndiàn 318  
 miándóu 131  
 miànfēn 138  
 miànfēnshuā 69  
 miànhuā 184  
 miànhuārúántáng 113  
 miànji 165, 310  
 miànjū 249  
 miànmó 41  
 miànqiú 41  
 miànshuāng 73  
 miànshuǐ shāngdiàn 213  
 miàntiào 158  
 miantuán 140  
 miányáng 185  
 miányángnǎi 137  
 miào 304  
 miǎobiào 234  
 miǎozhēn 304  
 midíxiāng 133  
 mièhuòqì 95  
 mifàn 158  
 mifàn bùdìng 140  
 mifēng 295  
 mifēngjī 83  
 mifēngpíng 135  
 mihóutáo 128  
 mijī zhēngqiú 221  
 mijian 129  
 mijian bùdìng 141  
 mimǎ 96  
 míngǎnxíngde 41  
 míngliàng 321  
 míngshèng 261  
 míngtiān 306, 320  
 míngwǎngxíng 280  
 míngxiāng 54  
 míngxīnpiàn 112  
 míniàokē 49  
 míniàoxìtǒng 19  
 mínjiān yīnyuè 259  
 mínzú 315  
 mipí 134  
 míshèngxīhúlu 125  
 miyuè 26  
 mó 82  
 mó'èrdūowǎ 316  
 módao 187  
 módaoqì 68, 118  
 módao shí 81  
 mógu 125  
 mójiàolán 133  
 móluògē 317  
 mónàgē 316  
 mósāngbīkē 317

mósuǐde 132  
 móte 169  
 mótiān dàlóu 299, 300  
 mótuōchē 204  
 mótuōchē yuèyèsài 249  
 mótuōchēsài 249  
 mòxīgē 314  
 móxing 190  
 móxing zhizuò 275  
 mòzélèilè gānlào 142  
 MP3 bōfāngjī 268  
 mù 254  
 mùcái 187  
 mùcái rǎnsèjī 79  
 mùcǎijiāo 78  
 mùchǎng 182  
 mùchuí 275  
 mùdǎn 111  
 mùdidi 213  
 mùgān 233  
 mùgōng 275  
 mùgōng zuàntóu 80  
 mùguānyuèqì 257  
 mùjiàng 188  
 mùjiānxiūxī 254  
 mùjīng 167  
 mùlǐ 121  
 mùniú 185  
 mùqīn 22  
 mùqún 183  
 mùshào 68  
 mùshù 124  
 mùsī 141  
 mùtàn 266  
 mùtóu 79, 275  
 mùxíng 280  
 mùxu 297  
 mùyángchǎng 183  
 mùyúrú 73  
 mùzhǐ 15  
 mùzhīqiú 15

## N

nǎi 136  
 nǎichá 149  
 nǎifēn 137  
 nǎihé 136  
 nail 320  
 nǎilào 136, 156  
 nǎilàopí 136  
 nǎipíng 75  
 nàirè 69  
 nǎixī 137, 149  
 nǎiyóu 137, 140, 157  
 nǎiyóu dàngāo 140  
 nǎiyóu xiànbīng 141  
 nǎiyóudàngāo kǎomú 69  
 nǎiyóudòng 141  
 nǎiyóugānlào 136  
 nǎiyóugāodiàn 157  
 nǎiyóupàofú 140  
 nǎiyóuxīngréntáng 113  
 nǎizǐ 75  
 nāmíbiyà 317  
 nán 312  
 nánbānqióu 283  
 nándàyáng 313  
 nánfēi 317

- nánguā 125  
nánguāzǐ 131  
nánhái 23  
nánhuiguixiàn 283  
nánmèizhōu 315  
nánpéngyǒu 24  
nánrén 23  
nánshèng 162  
nánxing 12, 13, 21  
nányányuán 254  
nánzhuāng 32, 105  
nǎo 19  
nǎozhèndàng 46  
nàozhōng 70  
nèibù 200  
nèichédào 194  
nèifenmikē 49  
nèifenmixitǒng 19  
nèihé 282  
nèihoushíjīng 198  
nèiqiānshì yíchú 171  
nèitāi 207  
nèitúcéng 83  
nèiyè 228  
nèiyìkù 32  
nèiyuán 84  
nèizàng 18  
nènmǎlǐngshù 124  
nènyuánbáicài 123  
nián 306, 307  
niánjí 163  
niánlǎo 321  
niánqīng 321  
niántǔ 85, 275  
niǎo 292  
niàobù 75  
niàodào 20  
niǎogé 121  
niàozhèngāo 74  
nibó'ěr 318  
nichán 52  
niè 289  
nièzi 47, 167  
nǐjiālǎguā 314  
nílóng 277  
níngjiāo 109  
níngméng 126, 151  
níngméngshuǐ 144  
níngméngcǎo 133  
níngméngchá 149  
níngméngjiàng 134  
nǐrièr 317  
nǐrǐlià 317  
nǐshuǐ 239  
niúdù 185  
niūkòu 32  
niúnǎi 136, 156  
niúnǎi kāfēi 148  
niúnǎi qiǎokèlì 113  
niúròu 118  
niúshāng 46  
niúshàngyāopái 119  
niúshé 118  
niútǔpái 119  
niúzǎijīngjī biàoyǎn 243  
niúzǎikù 31  
niúzhì 133  
nóngchǎng 183, 184
- nóngchàngyī 182  
nónghuó 183  
nóngjiā chāngyuàn 182  
nóngliè hēipíjiù 145  
nóngmín 182, 189  
nóngshè 182  
nóngtián 182  
nóngzuòwù 184  
nuǎnfēng kāiguān 301  
nuǎnqìpiàn 60  
nuǎnshuǐdài 70  
nǔér 22  
nǔféngrenshì 191  
nǔhái 23  
nuówei 316  
nǔpéngyǒu 24  
nǔrén 23  
nǔshāngren 175  
nǔshèng 162  
nǔshì chènshān 34  
nǔshì duǎnfā 39  
nǔshì duǎnshàngyī 35  
nǔshìzhè 191  
nǔshuǐyī 35  
nǔxíng 12, 20  
nǔxù 22  
nǔyányuán 254  
nǔyòng cháng shuǐyī 35  
nǔyòng nèikù 35  
nǔyòng nèiyī 35, 105  
nǔzhuāng 34, 105  
nǔzhūrén 64
- ōuqín 133  
òutù 44  
ōuzhōu 316  
ōuzhōufāngfēnggēn 125
- P  
pá 90  
pà'èrmǎ gānlǎo 142  
pái 210, 254  
pài 143  
páidēngjié 27  
páigǔ 119  
pǎilèi yùndòng 231  
páilǔàn 20, 52  
páiqiguān 203, 204  
páiqì 227  
páiqìxiāoyīnqì 203, 204  
páishuǐ 91  
páishuǐfá 61  
páishuǐgōu 299  
páishuǐguān 61  
pán 230  
pānbǐng 247  
pāndēngjià 263  
pàng 321  
pángguāng 20  
pángxiè 121, 295  
pànjué 181  
pànxíng 181  
pānyán 248  
pānyuán zhiwù 87  
pánzi 65  
páo 79  
pǎobùjī 250
- pǎochē 199  
páodào 212, 234  
pǎolèi 229  
pāomáo 217  
páomiàntú 282  
pàomò 148  
pàopào yuè 73  
pǎoqiú 221  
páoxíng dòngwù 293  
pázi 88  
pèicài 153  
pèidiànqì 203  
pèijīngshì 51, 189  
pèiǒu 23  
pèishètuán 180  
pèishènxì 180  
pèishi 36  
pèitāi 52  
péiyàngmǐn 166  
pēnfā 283  
péngkē yīnyuè 259  
péngren 67  
péngtiáo shǒufā 159  
péngquànqì 89  
péngwū 85  
péngyǒu 24  
pénhú 89  
pénhuā 111  
pénquán 85  
pēnshuǐ 91  
pēnshuǐkǒng 290  
pēnshuǐqì 199, 311  
pēntǐ 44  
pēntóu 89  
pēnwùguān 311  
pēnwùqì 89, 109  
pénzǎi zhiwù 87, 111  
pēnzui 89  
pí 119, 128  
pǐ 237  
piànmáyán 288  
piántóutǒng 44  
piányi 321  
piànzhuàng 132  
piàobáiji 77  
piáo chóng 295  
piào xi 76  
pífá 241  
pífú 14  
pífú báixì 41  
pífú huì 108  
pífúkē 49  
píhuātīng 241  
píjīn 173  
píjiǔ 145, 151  
píjiǔ lóngtóu 150  
píncǒurénxiàng 181  
píndào 178  
pínféng 277  
píng 135, 311  
píngdí rénzi tuòxié 57  
píngdìbōlibèi 65  
píngfāng 58  
píngfāng mí 310  
píngfāng yīngchǐ 310  
píngfēn 163, 230  
píngguō 126  
píngguō quèhèqì 68
- pingguōcù 135  
pingguōjiǔ 145  
pingguōzhǐ 149  
píng hēngmù 235  
píngjiǔ 223  
pingmiàntú 261  
pingmiàntúxíng 164  
pingmù 97, 176  
pingmù zuàntóu 80  
píngpāngqí 231  
píngpāngqiú 231  
píngsāi 166  
pingxíng 165  
pingxíngsìbiānxíng 164  
pingyuán 285  
pingzhí 165  
pingzhuāngshípǐn 134  
pingzhuāngshuǐ 144  
píngzǐ 61  
pínlǚ 179  
píntiè 275  
píntǔ 273  
píntuō 311  
pínxìé 162  
pínzi yóuxi 272  
pítǎbǐng 139  
pixiè 32, 27  
piyí 205  
pizàng 18  
pizhèn 44  
pōufúchǎn 52  
pōyāngshuǐ 52  
pùbù 285  
pūcǎopí 90  
pūdi fāngcháobù 267  
púfú zhiwù 87  
púgōngyǐng 123, 297  
púguāng 271  
púguāng búzú 271  
púguāng guòdù 271  
pūkèpái 273  
púlātí 250  
pùmian 85  
pútáo 127  
pútáogān 129  
pútáogānmiànbāo 139  
pútáojiǔ 145, 151  
pútáoshù 183  
pútáoyá 316  
pútáoyòu 126  
pútáoyuán 183  
pútáozhǐ 144  
pútáozǐyóu 134  
púzhuan 82
- Q  
qí 221, 232  
qí 308  
qián'ānqiáo 242  
qián'é 14  
qián'èdài 242  
qiánbào 37  
qiānbì 163, 275  
qiānchā 207  
qiānchuíxiàn 82  
qiándēng 198, 205  
qiándīlǎn 88  
qiánfēng 222
- qiáng 186  
qiángbi 58  
qiángfēng hángxíng 241  
qiánglizhǐjiá 173  
qiángqíjǔ 230  
qiángshǒuqì 272  
qiángzhuàng 321  
qiánjiá 37  
qiānjīndǐng 203  
qiánjiùchǐ 50  
qiānkè 310  
qiánlièxiàn 21  
qiánlún 196  
qiánmǎ 297  
qiánmén 58  
qiánmíng 96, 98  
qiánnián 307  
qiánqīlǚjià 210  
qiánqí 234  
qiánshuǐ miànzhào 239  
qiánshuǐfú 239  
qiánshuǐqū 239  
qiánshuǐtǐng 215  
qiántiān 307  
qiántiáo 89  
qiánzhèng 213  
qiánzhui 244  
qiánzǐ 167  
qiāokèlì 113  
qiāokèlì cuipiàn 141  
qiāokèlì dāngāo 140  
qiāokèlì nǎixi 149  
qiāokèlìhé 113  
qiāokèlìjiàng 135  
qiāokèlìqí 113  
qiáoliáng 300  
qiáopái 273  
qiāoqiāobǎn 263  
qībǎi 308  
qìchē 207  
qìchē 198, 200, 202  
qìchē lǎisài 249  
qìchē xiūlǐzhàn 199  
qìchē xuánjià 203  
qìchē yīnxiàng 201  
qìchuíguāng 71  
qídài 52  
qidiànchuán 215  
qíé 292  
qiēdǎ gānlǎo 142  
qiēgē 79  
qiēgēdǎo 81  
qiēguǎnjī 81  
qiējī 233  
qiēkuài 119  
qiēpiàn 67, 139, 140  
qiēpiānde 121  
qiēpiānjī 139  
qiēpiānmiànbāo 138  
qiērouchā 68  
qiēroudǎo 68  
qíézi 125  
qífēi 211  
qīgānggài 202  
qìguān 18  
qìháng 217  
qìjūshì 62  
qìkān 168



- qīluòjià 210  
 qímǎ 263  
 qímǎ zhuānyòngdào 263  
 qímèi(jiè) 23  
 qímèi(jiè)fū 23  
 qímén 207  
 qíméngān 247  
 qínbào 220, 221  
 qíncài 122  
 qīng 321  
 qīngbiàn zhédìetāngyī 165  
 qīngchú zácáo 91  
 qīngdòu 131  
 qīngfú 241  
 qīnggǎn 25  
 qīngjī 233  
 qīngjiāchēsài 243  
 qīngjiégōng 188  
 qīngjiéjī 77  
 qīngjiéyè 51  
 qīngjiéyòngjù 77  
 qīnglú 24  
 qīngqī 79, 83  
 qīngsǎo 77  
 qīngshàonián 23  
 qīngtíng 295  
 qīngxíng fēiji 211  
 qīngyú 120  
 qīngzhēng 159  
 qīngzhēnsi 300  
 qīngzhū dàngāo 141  
 qīngzhùhuì 140  
 qínjīng 258  
 qínǎ 258  
 qínqī 23  
 qínrou 119  
 qípán 272  
 qípán yóuxi 272  
 qípào xiàn 234  
 qípàoqi 234  
 qīshì 308  
 qīshǒu 242  
 qīshǒumào 242  
 qīsù 94  
 qītā diànpù 114  
 qītā gōngyī 275  
 qītāchuánxíng 215  
 qītāyùndòng 248  
 qītóng 207  
 qiú 75, 221  
 qiúbàng 225, 228, 249  
 qiúchǎng 226, 227, 228  
 qiúdào 232  
 qiúdòng 232  
 qiúduì 220, 229  
 qiúgān 224  
 qiújīnggānlán 123  
 qiújīngzhíwù 86  
 qiújiù diànhuà 195  
 qiújiù 233  
 qiúlán 226  
 qiúling 284  
 qiúmén 221, 222, 223, 224  
 qiúmén héngliáng 222  
 qiúmén qū 223  
 qiúmén xiàn 220, 223, 224  
 qiúménqū 220  
 qiúpāi 230
- qiúpāibǐng 230  
 qiúpāimián 230  
 qiúpāiwǎngxiàn 230  
 qiúqiān 263  
 qiúti 164  
 qiútiān 31, 307  
 qiútóng 231, 233  
 qiúwǎng 222, 226, 227, 231  
 qiúxié 220, 223  
 qiúyíhào 226  
 qiúyín 295  
 qiúyuán 220, 221  
 qiúzuò 233  
 qiwūji 44  
 qiyóu 199  
 qiyóubèng 199  
 qiyyè 306  
 qizhòngjī 187, 216  
 qizhuàngzhī 290  
 qizi 272  
 qizi 22  
 qizixīngchē 263  
 qù sípí 41  
 quǎnchǐ 50  
 quǎnqī 236  
 quǎnjiǐ bǐsài 237  
 quǎnjiǐ liànxi 237  
 quǎnjiǐ shǒutào 237  
 quǎnjiǐ tái 237  
 quǎnjīngzhào 271  
 quǎnmàimiànbǎo 139  
 quǎnmàimǎnfēn 138  
 quǎntóu 15, 237  
 quǎnxiēzhēn 173  
 quǎnbǐng 203  
 quǎnchǐ 50  
 quǎnchóngjī 108, 267  
 quǎndòngzhōu 202  
 quēbān 15  
 qūguāngdù 51  
 qūgūde 121  
 qūgūntēi yùndòng 224  
 qūgūnqū 224  
 qūgūnqū bàng 224  
 qūgūyúpiàn 121  
 qūjīngqī 271  
 qukéde 129  
 qukuāndān 96  
 quǎnlīde 121  
 quǎnbīan 34  
 quǎnzi 30, 34  
 quǎnqū 121  
 quǎnqūxiā 120  
 quǎnwūfēn 77  
 quǎnyù 299
- R**  
 rǎnfàji 40  
 rǎnqīqī 61  
 rǎnsède 39  
 rǎnyóuxiāng 204  
 ráogū 17  
 ràoxiànzhōu 276  
 ràoxīngdàolù 195  
 rè 286, 321  
 rècéng 286  
 rèdài 283  
 rèdàishuiguō 129
- règǒu 155  
 rèlātuómáo 41  
 rén 78, 89  
 rén 12, 16  
 rěndài 17  
 rěndǒng 297  
 rénjiuguānxī 24  
 rénlliziyuánbù 175  
 rénqiáng 222  
 rěnshēn jiǎnchá 52  
 rěnshēngdàshì 26  
 réntǐ 12  
 réntǐ móxíng 276  
 réntixītóng 19  
 rénxìangzhào 271  
 rénxíngdào 298  
 rénxínghéngdào 195  
 rényǎnqū 222  
 rénzàoěr 244  
 rénzàohuángyóu 137  
 rénzàowèixíng 281  
 rèqiǎokèlì 144, 156  
 rèqīqiú 211  
 rěshēn 250  
 rěshuǐ lóngtóu 72  
 rěyīn 144  
 rì 306  
 rìbēn 318  
 rìchéng 261  
 rìchū 305  
 rìguǐ 262  
 rìlì 306  
 rìluò 305  
 rìqī 306  
 róngbù niàobù 30  
 róngjī 83  
 róngjī 311  
 róngliàng 311  
 róngqī 311  
 róngxiù 277  
 róngyán 283  
 róngyī 321  
 róngyuán 294  
 ròu 118  
 ròudào 236  
 ròudiànlaobǎn 118  
 ròudoukǒu 132  
 ròudoukǒuyī 132  
 ròuguī 133  
 ròujiàng 142, 156  
 ròupí 119  
 ròupù 114  
 ròuqīn 107  
 ròutāng 158  
 ròuwán 158  
 ròuxiàn 119  
 ròuzhī zhíwù 87  
 ruǎn 129, 321  
 ruǎn yīnlǎo 144, 154  
 ruǎngāo 109  
 ruǎngū 17  
 ruǎnguǎn 311  
 ruǎnjiàn 176  
 ruǎnmiànbiāopiàn 139  
 ruǎnmù 79  
 ruǎnmùsāi 134  
 ruǎnnǎilào 136  
 ruǎnpán 176
- ruǎnxīndòulítàng 113  
 rúchǎngfēi 260  
 rúdiàn 53  
 rúfáng 12  
 ruidiàn 316  
 ruishì 316  
 rújīngjiǎnchá 212  
 rúkǒu 59  
 rùnfùlù 73  
 rùnhóupiàn 109  
 rǔniúchǎng 183  
 rǔshì dàoqiè 94  
 rǔshuǐ 71  
 rǔtáng 137  
 rǔtóu 12  
 rǔxué 26  
 rǔzhīpīn 107  
 rǔzhīpīn 136
- S**  
 sà'ěr wādūo 314  
 sàixīngdào 316  
 sǎhālā shāmò 313  
 sāi 294  
 sà'ěr wéiyà 316  
 sàichē 205, 206, 249  
 sàichēshǒu 249  
 sāihóng 40  
 sāilǎiliáng 317  
 sàimǎ 243  
 sàimǎ(bìsài) 243  
 sàimǎchǎng 243  
 sàinèijiǎ'ěr 317  
 sàipào 234  
 sàipǔlǔsī 316  
 sàishì 243  
 sāixiànyán 44  
 sāixù 290  
 sāizi 72  
 sàkèsīguǎn 257  
 sàlǎmǐ xiǎngchǎng 142  
 sǎn 36, 233  
 sān 308  
 sānbǎi 308  
 sāncéng 104  
 sānfēnxiàn 226  
 sāngnáyú 250  
 sāngguāng 51  
 sānji 109  
 sānjiǎobǎn 165  
 sānjiǎoji 16  
 sānjiǎojià 166, 270, 281  
 sānjiǎoméi 301  
 sānjiǎonèikǒu 33  
 sānjiǎoqiáng 300  
 sānjiǎotiè 257  
 sānjiǎoxíng 164  
 sānlóu tīngzúo 254  
 sānmén 200  
 sānménzhù 225  
 sānmíngzhì 155  
 sānmíngzhì guitái 143  
 sànrèqī 202  
 sānshì 308  
 sāntóuji 16  
 sānxiāngchē 199  
 sānyuè 306  
 sāochú 77
- sāomiáoyī 176  
 sǎwǎng 245  
 sǎzīmìànbǎo 139  
 sèdiào 41  
 sènlín 285  
 shā 264  
 shābǎo 265  
 shābù 47  
 shāchē 200, 204, 206, 207  
 shāchēpiàn 207  
 shāchētàbǎn 205  
 shāchóngjī 89, 183  
 shāchuí 257  
 shādài 237  
 shādingyú 120  
 shāfā 62  
 shāfāchuāng 63  
 shāguō 69  
 shāi 91  
 shāi rìguāngyù 264  
 shāihòu hǔfūyè 108  
 shāisǎ 138  
 shàishāng 46  
 shāizi 89  
 shāikēng 232  
 shāilā 149  
 shāmò 285  
 shān 284  
 shānbèi 121  
 shāndiàn 287  
 shāndìchē 206  
 shàngcài 64  
 shàngchuán 217  
 shàngchuāng shuǐjiào 71  
 shàngdiàn 298  
 shàngè 19  
 shàngguāng 77  
 shàngguāngjī 77  
 shàngjiāngshuā 82  
 shāngkǒu 46  
 shānggrén 175  
 shāngsù 181  
 shāngǔ 284  
 shāngguāngdēng 270  
 shāngwù 175  
 shāngwúcāng 211  
 shāngwùlǔxíng 175  
 shāngxiàbàn gāofēngqī 209  
 shāngyèjiāoyī 175  
 shāngzhōu 307  
 shāngzhuāng 32, 34  
 shānhújiāo 285  
 shānmài 282  
 shānmàoju 296  
 shānpō 284  
 shānyáng 185  
 shānyángnǎi 136  
 shānyángnǎilào 142  
 shānyào 125  
 shānyè 60  
 shānzhūguō 128  
 shāobēi 167  
 shāokǎo 67  
 shāokǎojià 267  
 shāopíng 166  
 shāoshāng 46  
 shātè'ǎilābō 318

- shātū 85  
shāxiāng 263  
shāyán 288  
shāyú 294  
shāzhǐ 81, 83  
shé 19, 293  
shédìng nàozhōng 71  
shèjī 249  
shèjiàn 249  
shèjīngguān 21  
shèjìshī 277  
shémén 223  
shèn 119  
shēnfēnbiāoqiān 53  
shēng 315  
shēng 124, 129, 311  
shēng miàntuán 138  
shēnggāoji 45  
shēngbīngde 321  
shēngdài 19, 255  
shēngdànjie 27  
shēngduōmēi hé pǔlínxībī 317  
shēnghào 256  
shēngjīcí hé níwéisī 14  
shēnglúxiyà 314  
shēngmǎlinuò 316  
shēngri 27  
shēngri dàngāo 141  
shēngri júhui 27  
shēngri làzhú 141  
shēngròu 142  
shēngsuò 207, 248  
shēngtán 301  
shēngwénsèntè hé gélínnàdīngsī 314  
shēngwúxué 162  
shēngyīhuòbàn 24  
shēngzhí 20  
shēngzhìqí 12  
shēngzhìqiguān 20  
shēngzhìxītóng 19  
shēngzī 26  
shēnhǎi chuídiào 245  
shēnhèshè 39  
shénjīng 19, 50  
shénjīngkē 49  
shénjīngxītóng 19  
shēnkǒu yuánchí 68  
shēnshuǐqū 239  
shènzàng 18  
shēnzhān 250  
shēnzhāntuī 250  
shèxiàngjī 178  
shèxiàngjī shēngjiàngqí 178  
shèxiàngshí 178  
shèyǐng 270  
shèyǐngshī 191  
shí 280, 308  
shí'èr 308  
shíbā 308  
shíbīng 189  
shíchāng 115  
shíchāngbù 175  
shichuāng 177  
shidài 23  
shíèryuè 306  
shìèrzhichāng 18  
shíféi 91
- shígāo 83  
shígōng zuàntóu 80  
shìgù 46  
shìguān 19, 166  
shìguānjià 166  
shìhuìshì 85  
shìhuìyán 288  
shìjī 307  
shìjiān 234, 304  
shìjiè ditú 312  
shìjīnshālā 158  
shìjiū 308  
shìkèbiào 197, 261  
shìli 51  
shìli jiānchá 51  
shìliú 128  
shìliú 308  
shìliúshí 288  
shìlú 133  
shìmián 71  
shìmiànlǜ 85  
shìmò 289  
shìnánhuà 297  
shìnèi biānpào 31  
shìnèi xītóng 60  
shìnián 307  
shìpín 105  
shìpín jiāgōngqí 66  
shìpín yóuxi 269  
shìpín zǎhuò 106  
shìpíntān 154  
shìpínzǎhuòdiàn 114  
shìqí 308  
shìqū 299  
shìrùn 286  
shìsān 308  
shìshàng 277  
shìshèngjīng 51  
shìsī 308  
shìtóu 275  
shìwàn 309  
shìwǎngmó 51  
shìwú 118, 149  
shìwú 308  
shìwùlǎn 263  
shìyàn 166  
shìyànshì 166  
shìyī 309  
shìyī 308  
shìyǐng 289  
shìyǐnqí 258  
shìyíyù 306  
shìyòng shuōmíng 309  
shìyú 306  
shìzhè 148, 152  
shìzhèn 304  
shìzhèn 44  
shìzhèngtǐng 299  
shìzhí 15  
shìzhìjīn 74, 108  
shìzhōng shōuyǐnjī 70  
shìzhuāngdiàn 115  
shìzi 128  
shìzi 291  
shìzilùkǒu 298  
shòu 321  
shǒu 13, 15  
shǒubi 13
- shǒubiào 36  
shǒubíng 61  
shǒuchā 89  
shǒudòng 200  
shǒudù 315  
shǒufèi pīndào 269  
shǒufèizhān 194  
shǒuhú 91, 183  
shǒuhuòyuán 104, 188  
shǒujiànlán 172  
shǒujiànxiāng 177  
shǒujǐng 20  
shǒujù 81, 89  
shǒujù 152  
shǒukào 94  
shǒukǎnjī 106, 150  
shǒukǎntái 106  
shǒulèiyuán 228  
shǒulún 276  
shǒuményuán 222, 224, 225  
shǒupà 36  
shǒupiāochú 209, 216, 255  
shǒuqiāng 94  
shǒuqū 229  
shǒuròu 118  
shǒusān jiāofān 240  
shǒushāchē 203  
shǒushì 36  
shǒushidiàn 114  
shǒushìhè 36  
shǒushù 48  
shǒushù jǐlǚbiào 48  
shǒushùshì 48  
shǒutào 36, 224, 233, 236, 246  
shǒutǎo 37  
shǒutǎnshì yǐng'érchuāng 75  
shǒutǎnxínglǐ 208, 213  
shǒutuīchē 208  
shǒuwán 13, 15  
shǒuxiàn 245  
shǒuyǎn 254  
shǒuyáo qǐbīngzuàn 78  
shǒuyáozaun 81  
shǒuyī 189  
shǒuyǐnjī 268  
shǒuyínyuán 106  
shǒuzhǎng 15  
shǒuzhìde 48  
shǒuzhuó 36  
shù 86, 296  
shù 168, 273  
shuāi 237  
shuāidào 237  
shuāigān 76  
shuāigānjī 76  
shuāijiào 236  
shuāng 287  
shuāngbàotāi 23  
shuāngcéng gōnggōngqīchē 196  
shuāngdǎ 230  
shuāngfēn 151  
shuāngfúshuǐ 41  
shuānggàng 235  
shuāngguāngde 51  
shuānghuāngguān 257  
shuāngjī 109
- shuāngmén 200  
shuāngmén bīngxiāng 67  
shuāngrénchuāng 71  
shuāngrénjiān 100  
shuāngshēnfēn 73  
shuāngtào mǎchēsài 243  
shuāngtǐchuān 215  
shuāngtǒng wàngyuānjīng 281  
shuāngyèjiàng 241  
shuāngyī fèiji 211  
shuāngzú zìxíngchē 206  
shuānji 109  
shuāqī 83  
shuātóufā 38  
shuāxi 77  
shuāyá 50  
shuāzī 83  
shūbào 162  
shūbiào 176  
shūcài 107, 122, 124  
shūcài bǎoxiāngé 67  
shūcài hǎnbào 155  
shūcài shālà 158  
shūcài shuǐguòdiàn 114  
shūcài shuǐguòshāng 188  
shūdài xióng 291  
shūdiàn 115  
shūfáng 63  
shūfú 35  
shūgǎn 296  
shuǐ 96  
shuǐ 144  
shuǐbà 300  
shuǐcǎi huàyuánliào 274  
shuǐchǎndiàn 114, 120  
shuǐdài 267  
shuǐdào 184  
shuǐdiàn 267  
shuǐdòu 44  
shuǐfèi qiánshuǐ 239  
shuǐguān 151  
shuǐguān 202  
shuǐguānchē 89  
shuǐguò 107, 126, 128  
shuǐguò dàngāo 140  
shuǐguò xiànbǐng 140  
shuǐjīng huàyuán 84  
shuǐjīng liáofǎ 55  
shuǐliáo 55  
shuǐlóng 95  
shuǐlóngtóu 61, 55  
shuǐmián 74  
shuǐmù 295  
shuǐní 186  
shuǐníjiāobànqì 186  
shuǐnuǎngōng 188  
shuǐpào 46  
shuǐpíng 206, 267  
shuǐpíngwéiyī 210  
shuǐpíngyī 80  
shuǐqí 239  
shuǐshàng fèiji 211  
shuǐshàng mótuō 241  
shuǐshàng yùndòng 241  
shuǐshèng zhìwù 86  
shuǐshǒu 189  
shuǐtǎ 290  
shuǐtǒng 77
- shuǐxià hūxiǎguān 239  
shuǐxiāng 61  
shuǐxing 280  
shuǐyī 31, 33  
shuǐyītǐng 215  
shuǐzhàngài 232  
shuǐzhù 95  
shuǐzhù 159  
shuǐzhūnyī 187  
shǔjià 63, 168  
shǔjià 273  
shǔjūguān 180  
shǔjūngguān 21  
shǔkǒuchi 50  
shǔkǒuyè 72  
shǔlǐ 85, 90, 182  
shǔlín 285  
shǔluǎngguān 20  
shǔmù xiàngjī 270  
shǔmíng 168  
shǔmù 168  
shǔmù zhìzhuàng 90  
shǔniàoguān 21  
shǔnshì liáofǎ 55  
shǔcài shuǐguòshāng 259  
shuòshìxuéwèi 169  
shūpí 296  
shūpiàn 113  
shūqín 256  
shūrén 24  
shūròu 118, 143  
shúshí 107  
shúshìdiàn 142  
shútào 154, 155  
shútóu 38  
shǔwéicǎo 133  
shǔxué 162, 164  
shǔyè 53  
shǔzhi 296  
shǔzhuāngtái 71  
shǔzi 308  
shǔzishi 269  
sì 308  
sībā 308  
síchóu 277  
sīdài 39, 235  
sìguānlù 73  
sījī 196  
sìjīdòu 122  
sìliàocáo 183  
sìlǐlǎnkā 318  
sìlúnqūdòng(chē) 199  
sìlúfákè 316  
sìlúwénnià 316  
sīmèn 200  
sīmào 300  
sìqūxiàn 221  
sīrén jiàoliàn 250  
sīrén pēnqìshì fèiji 211  
sìshí 308  
sìshí fēnzhōng 304  
sītóujī 16  
sīwáng 26  
sīwéishìlǎn 317  
sīyǎng 183  
sīyuè 306  
sōngbīng 140  
sōngbīng kǎopán 69



sòngcān 154  
 sōnggāo 140  
 sōngjiéyóu 83  
 sōngjīn wàdài 35  
 sōngróuchuí 68  
 sōngshù 296  
 sōngshù 290  
 sōngtǔ 91  
 sōngzhìqì 172  
 sōngzǐ 129  
 sōusuó 177  
 suān 127  
 suānbàn'er 125  
 suānchéng 126  
 suāncù tiáowèizhī 158  
 suānlàijiàng 135  
 suānmiànbāo 139  
 suānmó 123  
 suānnāi 137  
 suānnāiyóu 137  
 suànshù 165  
 suànwèilācháng 143  
 sūdǎ miànbāo 139  
 sūdǎ shuǐ 144  
 sūdān 317  
 sùdì 99  
 sùhuá 247  
 suǐjǐ cúnchúqì 176  
 suǐlǐxiàomài 130  
 suǐnǎilào 136  
 suǐshì 88, 288  
 sùjǐyuán 181  
 sùliào niàokù 30  
 sùliàodài 112  
 sùliàohé 321  
 sùlínán 315  
 sùmiáo 275  
 sùmiáobù 275  
 sùn 292  
 sūnnǚ 22  
 sūnzǐ 22  
 sūnzǐnǚ 23  
 suǒ 59  
 suǒgù 17  
 suǒgù 239  
 suǒluómén qúndǎo 319  
 suǒmǎlǐ 317  
 suǒxiǎo 172  
 sùsóng ànjìàn 180  
 sùsòngwèituóérén 180  
 sùyíngdì 266

## T

tǎ 300  
 tàbǎn 61  
 tàbùjǐ 250  
 tàdēng 217  
 tài'er 52  
 tàifèitáng 113  
 tàiguó 318  
 tàijíquán 237  
 tàikōngfú 281  
 tàimiàn 207  
 tàipán 52  
 tàipíng yáng 312  
 tàiqián 78  
 tàiqiú 249  
 tàiquán 236

táiquándào 236  
 tàitài 23  
 táiwǎn 319  
 tàiyā 203  
 tàiyáng 280  
 tàiyángjīng 51, 265  
 tàiyángxì 280  
 tàiyángxuè 14  
 tàijiāotào 207  
 tàijìkèsītǎn 318  
 tànbǐ 275  
 tāng 153, 158  
 tāngchí 65  
 tāngfā 39  
 tāngguō 113  
 tāngguódiàn 113  
 tāngjiāng 109  
 tāngláng 295  
 tāngniàobīng 44  
 tāngpén 65  
 tāngshuāng 141  
 tánhuáng 71  
 tánhuángchéng 166  
 tānsāngnià 317  
 tànsǐ shǐjiān 48  
 tànsuān 144  
 tànxì 25  
 tànyuán 94  
 tànzhen 50  
 tànzǐ 71, 74  
 táo 126, 128  
 táocǐ cǎnjū 64  
 táocǐ lútái 66  
 tàojiàodài 241  
 tàotǎn 163  
 tàotǒng 80  
 tàotǒng bànsou 80  
 tàotóumáoyǐ 33  
 táoyǐ 275  
 táozhìdùnguō 69  
 tàsīmānià(yà)(dào) 319  
 tàyǔ 120  
 tèjìtiàosǎn 248  
 tèlínidá hé duóbāgē 314  
 téngjià 84  
 tèsecài 152  
 tí 291  
 tí'àn 174  
 tián 124, 127  
 tiáncài 125  
 tiánchōngwù 50  
 tiánchuāng 202  
 tiāndì 182  
 tiāndiǎnpán 65  
 tiānè 293  
 tiānguā 127  
 tiānhuābǎn 62  
 tiānjiàng 134  
 tiānjiào 124  
 tiānjīng xuānshǒu 234  
 tiānjīng yùndòng 234  
 tiánliào 83  
 tiānpíng 166  
 tiānqì 286  
 tiānrán xiānwéi 31  
 tiānshí 107  
 tiānshí xiǎochē 152  
 tiānshìdiàn 113

tiānwángxíng 280  
 tiānwēide 155  
 tiānwén wàngyuánjīng 281  
 tiānwénxuè 281  
 tiānxián gǎnlǎn 143  
 tiányècài 123  
 tiányumi 122  
 tiàobǎn 235, 238  
 tiàogāo 235  
 tiàojiào 271  
 tiàojiào xuānniǚ 167  
 tiàomǎ 235  
 tiàoqiú 226  
 tiāorán 39  
 tiāosǎn 248  
 tiào sèbǎn 274  
 tiàoshèng 250  
 tiàoshuǐ 238, 239  
 tiàoshuǐ xuānshǒu 238  
 tiàotái huáxuè 247  
 tiàotǐ 237  
 tiàotóu 227  
 tiào wēi 159  
 tiào wēipín 135  
 tiào wēizhī 135  
 tiào xingmǎ 106  
 tiào xingmǎ sāomiàoqi 106  
 tiào yǎn 179  
 tiào yuán 235  
 tiào yuè 243  
 tiào zhǐjiētiàoqi 176  
 tiàobùduiyuán 223  
 tīcǎo 235  
 tīcǎo xuānshǒu 235  
 tīdài liáofā 54  
 tīdào dǎopiàn 73  
 tiē 109, 289  
 tiē (qiángzhǐ) 82  
 tiēbǐng 234  
 tiēbǐzhǐ 82  
 tiēgān 233  
 tiēguǐ 208  
 tiēlǔwǎng 209  
 tiēqiāo 187  
 tiēsǐjiān 81  
 tīgōng zhùsù hé zǎocǎn 101  
 tīhù 292  
 tījǐ 165  
 tījiàn 45  
 tīkuǎnjǐ 97  
 tīngbó 217  
 tīngchē 195  
 tīngchē ànniǚ 197  
 tīngchē jǐshì shǒufèiqì 195  
 tīngchēchǎng 298  
 tīngdiàn 60  
 tīngjīng 180  
 tīngjǐpíng 212  
 tīngtǒng 99  
 tīngyuán 261  
 tīngyuán 58, 84  
 tīngyuán 241  
 tīngzhènqì 45  
 tīngzhǐ 269  
 tīqiú 221, 223  
 tīshǒu 37, 106  
 tiwén 163  
 tiwēnjǐ 45

tíxíng 164  
 tīxù 73  
 tīxūpàomò 73  
 tiyù 162  
 tiyùchǎng 223  
 tiyùyùndòng 105, 220  
 tīzhōngjì 45  
 tīzǐ 186  
 tóng 289  
 tǒng 82, 265  
 tǒngfēngkǒu 210  
 tǒngguān yuèqì 257  
 tonghuā 273  
 tǒngkǒng 51  
 tǒngpái 235  
 tǒngshēn 61  
 tǒngshì 24  
 tǒngwēncéng 286  
 tǒngxùn 98  
 tǒngzhuāng 30  
 tóu 12  
 tóubidiànhuà 99  
 tóubìshì zìdòngxiyídiàn 115  
 tóubù 19  
 tóubù sùnshāng 46  
 tóudǐng suǒguì 210  
 tóufa 14, 38  
 tóujǐngbù sùnshāng 46  
 tóukuǐ 95, 204, 206, 220, 228  
 tóukuǐmiànzhào 205  
 tóulán 227  
 tóumíngjiāodài 173  
 tóupi 39  
 tóupixiè 39  
 tóuqiú 222, 225, 229  
 tóuqiúqū tūdūn 228  
 tóuqiúshǒu 225, 229  
 tóushā 35  
 tóutǒng 44  
 tòuzhǐ 96  
 tóuzǐ 272  
 tóuzǐ 97  
 tóuzǐ gùwèn 97  
 tǔ'èrqì 316  
 tuántǐlǚyóu 260  
 túbiāo 177  
 túbiào shífèi 90  
 túbùxuè 267  
 tǔdǐng 173  
 tǔdǐng 39  
 túhù 188  
 tuī 12, 13, 119  
 tuībikǒu 99  
 tuìgān 233  
 tuìjiànshùmu 168  
 tuìjīnqì 281  
 tuìxiú 26  
 tǔkùmǎnsītǎn 318  
 tún 13  
 tūnisǐ 317  
 túnjǐ 161  
 tuōbā 77  
 tuōchē 203, 266  
 tuōchuán 215  
 tuófēng 291  
 tuōjū 35  
 tuólājǐ 182  
 tuóniǎo 292

tuōpǎn 152, 154  
 tuōshuǐde 129  
 tuōxié 31  
 tuōyuánxíng 164  
 tuōzhǐ nǎiyóu 137  
 tuōzhǐ niú'nǎi 136  
 tuōzǒu 195  
 tǔrǎng 85  
 tǔrǒu 118  
 tǔshǔguān 168, 299  
 tǔshǔguānlǚyuán 168, 190  
 tǔxing 280  
 tǔzǐ 290  
 Txùshān 30, 33

## V

Vxínglíng 33

## W

wā 90, 294  
 wàibì 97  
 wàibì duìhuànchù 97  
 wàibiào 30  
 wàibù 198  
 wàichédào 194  
 wàichū 75  
 wàichū jiùcǎn 148  
 wàidài 154  
 wàifǔ qiǎokèlì 140  
 wàihé 282  
 wàihùshǔjīng 198  
 wàikè 130  
 wàikè 49  
 wàikè yǐshēng 48  
 wàipí 126, 142  
 wàishēng 23  
 wàishēngnǚ 23  
 wàisūnzǐnǚ 23  
 wàitào 32  
 wàitúcéng 83  
 wàiyè 229  
 wàiyìcéng 286  
 wàiyǐn qièkǎishù 52  
 wàizǔfǔmǔ 23  
 wǎjuéjǐ 187  
 wán 273  
 wǎn 65  
 wǎncǎn 64  
 wǎncǎn càidǎn 152  
 wǎndiàn 209  
 wǎndòu 122  
 wǎng 272  
 wǎngbù 245  
 wǎngluò 176  
 wǎngpái 273  
 wǎngqiú 230  
 wǎngqiúchǎng 230  
 wǎngqiúshǒu 231  
 wǎngqiúxié 231  
 wǎngzhàn 177  
 wǎnjia 273  
 wǎnjù 75, 105  
 wǎnjǔlán 75  
 wǎnjǔwú 75  
 wǎnlǐfú 34  
 wǎnqú 165, 250  
 wǎnshèngjié 27

- wánwūtú 319  
wánzhèng 129  
wǎpiàn 58, 187  
wǎqīngān 233  
wáwa 75  
wáwáwū 75  
wáyōng 239  
wázi 33  
wèi 320  
wèi 290, 292, 294  
wèi 18  
wèi jīngguò bāshìxiàodúde 137  
wèi mǔrú 53  
wèiba 242  
wèibólú 66  
wèibù 121  
wèibùchémén 198  
wèichāng 243  
wèidēng 204, 207  
wèidimālā 314  
wèidóu 30, 50  
wéigān 240  
wèihūnfú 24  
wèihūnfúqī 24  
wèihūnqī 24  
wéijīn 31, 36  
wéilán 182  
wèinèiruiliā 315  
wéiqún 69  
wèishēng hùdiàn 108  
wèishēng miántiáo 108  
wèishēngjiān 104, 266  
wèishēngjīn 108  
wèishēngsù 108  
wèishēngzhǐ 72  
wèishìjī 145  
wèishúde 129  
wèitōng 44  
wèixiàn 283  
wèixiàn 195  
wèixiào 25  
wèixīng dǎohángyí 201  
wèixīng diànshì tiānxiàn 269  
wèixīngchē 199  
wéiyì 210  
wèizhuī 17  
wèizuí 30  
wèn 293  
wèndìnglún 207  
wèndù 286  
wèndùjī 167, 201  
wénjiàn 177  
wénjiànguī 172  
wénjiànché 173  
wénjiànjiā 172, 177  
wénjù 105  
wénlái 319  
wènnuān 286  
wénpíng 169  
wénshēn 41  
wénshì 85  
wèntí 163, 171  
wénxiàngbǎn 241  
wènxué 162, 169  
wénxúnchú 168  
wénzhàng 267  
wénzi 295
- wénzi xùnxī 99  
wōjū 123  
wólúnzēngyǎqī 203  
wōniú 295  
wòpùchēxiāng 209  
wòshì 70  
wòshìyīng'érchē 75  
wù 287  
wǔ 308  
wǔbǎi 308  
wǔbiānxíng 164  
wǔcān 64  
wǔcān càidān 152  
wúdài biànxíe 37  
wúdǎoxuéyuán 169  
wúdǎoyǎnyuán 191  
wúding 58  
wúdingchuāng 58  
wúdinghuayuán 84  
wúdòuchú 70  
wūgāndá 317  
wúgōng 295  
wúguāngqī 83  
wúguāngzè 83, 271  
wúguǐdiànchē 196  
wúhé 127  
wúhémìjū 126  
wúhépútāogān 129  
wúhèxiāopútāogān 139  
wúhuāguǒ 129  
wújiāndài 34  
wújīndiàn 114  
wújīng 124  
wújīng 167  
wújīnggānlán 125  
wújīzhuī dòngwù 295  
wújūn 47  
wúkèlán 316  
wūlāguī 315  
wūli 162  
wūliáo 25  
wūlixué 169  
wúmíngzhǐ 15  
wúqian 199  
wúqū 259  
wúshéng diànhuà 99  
wúshí 308  
wúshù 237  
wúshuiguān 61  
wútái 254  
wútáicèyì 254  
wútángfēnde 145  
wúwǎn 309  
wúxiàndiàn guǎngbō 179  
wúxiàndiàn tiānxiàn 214  
wúxiànpǔ 256  
wúxiù 34  
wūyā 292  
wūyán 58  
wúyánde 137  
wúyè 305  
wúyuè 306  
wūzéi 121  
wúzhàng'àisaimǎ 243  
wúzhé 98  
wúzhibiékèsītān 318  
wúzuī 181  
wúzuīshífāng 181
- X  
Xguāng 48  
Xguāng xīnglǐ jiǎnchájī 212  
Xguāngxiàn kànpianqī 45  
xi 169  
xī 38, 77  
xī 12, 289, 312  
xià'è 14  
xiàbà 14  
xiàgǒu 284  
xiàn 258  
xiàn 19, 155, 165, 276  
xiànbǐng 158  
xiànbǐng kǎomú 69  
xiànchūāng 214  
xiānduānbù zuàntóu 78  
xiàng 272, 291  
xiāng 130  
xiàng hòu huīgān 233  
xiàng...fāngxīang 320  
xiāngbāobù 104  
xiàngbī 291  
xiāngbīnjiǔ 145  
xiāngcái 133  
xiāngcǎo 132, 133, 134  
xiāngcǎo huàyuán 84  
xiāngcè 271  
xiāngcháng 118, 155, 157  
xiāngcūn yīnyuè 259  
xiàngguǒ 125  
xiàngjī zhōnglèi 270  
xiàngjiān huàyuán 84  
xiāngjiào 128  
xiàngjiào ruànguǎn 89  
xiāngjiāoxuē 89  
xiàngjīhè 271  
xiāngkuàng 271  
xiàngliàn 36  
xiàngliànzhui 36  
xiāngliàobāo 132  
xiàngmù 247  
xiàngpī 163  
xiàngpiān 271  
xiàngpǐgāo 47  
xiàngpítǔzhāng 173  
xiàngpǔ 237  
xiàngrikuí 184, 297  
xiàngrikuízǐ 131  
xiàngshàng 320  
xiàngshù 296  
xiāngshuǐ 41, 105  
xiāngsuǒ 157  
xiàngxià 320  
xiāngxīnlǎo 132  
xiāngyān 112  
xiāngyóu 134  
xiāngzhīcù 135  
xiāngzǐlán 132  
xiānhuà zhīwù 297  
xiànjū 81  
xiānnǎilǎo 136  
xiānrénzhāng 87  
xiānrénzhāngguǒ 128  
xiānshēng 23  
xiānshìpíng 269  
xiānshìqī 172, 176  
xiànshù 277  
xiànshù 195
- xiántǐ 214  
xiànwǎimádá 215  
xiānwéi 127  
xiānwéibǎn 79  
xiānwèijīng 167  
xiányífan 94, 181  
xiányuè 280  
xiányuèqī 256  
xiànzài 304, 320  
xiánzhèn 258  
xiánzhóu 245, 258, 276, 277  
xiào 321  
xiào 25  
xiàobi 12  
xiàobiàn 39  
xiàobīngxiāng 101  
xiàocānglǎn 110  
xiāocháng 18  
xiàochē 196  
xiàochuán 44  
xiāochuántíngkǎoqū 217  
xiàodào 262  
xiàodiàoxiàng 260  
xiàodòukǒu 132  
xiàodù shījīn 47  
xiàodùjī 47  
xiàodùyè 51  
xiāofāngchē 95  
xiāofāngdù 95  
xiāofāngduiyuán 95, 189  
xiāofāngfú 95  
xiāofāngshuān 95  
xiāofāngtǐ 95  
xiāofāngtōngdào 95  
xiāofāngzhàn 95  
xiāofèi 152  
xiàofú 162  
xiāogǒu 290  
xiāohàibào 290  
xiāohào 257  
xiāohóngluóbō 124  
xiāohuà 122  
xiāohuàxìtǒng 19  
xiāohuixiāng 132  
xiāohuizhuān 247  
xiàoji 185  
xiàojiāshù 290  
xiàojiè 23  
xiàojiè 299  
xiàojiéxiàn 256  
xiàojīng 58, 85  
xiàojiǔngǔ 257  
xiàolìcàidòu 131  
xiàolóngxià 121  
xiàolún mótuó 205  
xiàomài 130, 184  
xiāomāo 290  
xiāomǐ 130  
xiāomiànbào 139  
xiàoniúròu 118  
xiàopǎo 243  
xiàoqú 230  
xiāoshānyáng 185  
xiāoshì 304  
xiāoshòubù 175  
xiàotǐqín 256  
xiàotuí 12  
xiàotuidǔ 13
- xiāoxiàng 298  
xiāoxīng gōnggòngqīchē 197  
xiāoxīngqiāo 247  
xiāoxīngxing 280  
xiàoyā 185  
xiāoyányào 109  
xiàoyuán 168  
xiàoyuán dāngāo 140  
xiàoyuán miànbào 143, 155  
xiàozhǎng 163  
xiàozhǐ 15  
xiàozhǐ 185  
xiàoshuǐ 118  
xiàoshuǐdào 299  
xiàotiān 31, 307  
xiàowéiyí 314  
xiàowù 305  
xiàzǎi 177  
xiàzhōu 307  
xībányà 316  
xībēi 53  
xībóliǎyà 313  
xībùpiān 255  
xíchángxingmiànbào 139  
xíchénqī 77, 188  
xiàixiè 37  
xidí 76  
xidícao 61, 66  
xidíyè 77  
xié 34, 37  
xiè 162  
xiébiān 164  
xiédài 37  
xiédí 37  
xiédìng 114  
xiédíng 233  
xiéfangjī 16  
xiégēn 37  
xiējùjià 81  
xiéshè 37  
xiéxuēbù 104  
xiéyān 37  
xièyào 109  
xiēzi 295  
xifānlíangguǒ 128  
xífāshuǐ 38  
xīguā 127  
xīguān 77, 144, 154, 167  
xīhúlu 124  
xījīāshuǐ 41  
xìjù 254  
xìjùpiān 255  
xīlǎ 316  
xīlǎnhuà 123  
xīlǐ 26  
xīlǐnyù 72  
xīliú 285  
xīmǎlǎyǎ shānmài 313  
xīn 98  
xīn 119, 122, 289, 321  
xīn gǔdiǎnzhùyì fēnggē 301  
xīn yīshù fēnggē 301  
xīnfēng 98, 173  
xīng 126  
xīng 280  
xīngbìng 20  
xīngfēn 25  
xīngjiāo 20



- xíngjūn chuāng 266  
xínglái 71  
xínglǐ 100, 198, 213  
xínglǐ chuānsòngdài 121  
xínglǐcāng 196  
xínglǐchē 100  
xínglǐjià 204, 209  
xínglǐtuīchē 213  
xínglǐtuōchē 212  
xínglǐxiāng 198  
xíngqī 306  
xíngqiè 306  
xíngqīliú 306  
xíngqīrì 306  
xíngqīsān 306  
xíngqīsì 306  
xíngqīwú 306  
xíngqīyī 306  
xíngren 129, 151  
xíngrenhú 141  
xíngrenyóu 134  
xíngxì 280  
xíngxíng 280, 282  
xíngyún 280  
xíngzhèngqū 315  
xíngzuò 281  
xínhào 209  
xīniú 291  
xīnjī gēngsè 44  
xīnjiāpō 318  
xīnnián 27  
xīnshèng'ér 53  
xīnshuǐ 175  
xīnwén 178  
xīnwén bōyīnyuán 179, 191  
xīnwén jìzhè 191  
xīnwén mèiti 178  
xīnxiān 121, 127, 130  
xīnxiāng 58, 99  
xīnxīlán 319  
xīnxípíng 213  
xīnxuéguānxìtǒng 19  
xīnyòngkǎ 96  
xīnyuè 280  
xīnzàng 18  
xīnzàngbǐngkē 49  
xióng 291  
xiōng 12, 119  
xiōngdi 22  
xiōnggǔ 17  
xiōngjī 16  
xiōngkuò 17  
xiōngmāo 291  
xiōngqí 294  
xiōngruǐ 297  
xiōngyálì 316  
xiōngzhào 35  
xiōngzhēn 36  
xiōngzhuī 17  
xipái 273  
xipíxiāogānjú 126  
xīrúqì 109  
xīrúqì 53  
xīsàhàlā 317  
xīshì xiànbǐng 143  
xīshìjì 83  
xīshǒuchí 72  
xīshuài 295
- xisuō'èr 240  
xītōng 176  
xītóupén 38  
xiūjiān 39, 91  
xiùkē 47  
xiùkòu 36  
xiùkǒu 32  
xiùlǐ gōngjùxiāng 307  
xiùlǐjiān 89  
xiùsè 25  
xiùxián 254  
xiùxián chuídiào 245  
xiùxián shàngyī 33  
xiūzhī 90  
xiūzhífú 256  
xiūzhǐjiān 89  
xiùzǐ 34  
xiwǎnjī 66  
xixiāngcōng 133  
xixīlǐdào 316  
xiyān 112  
xiyáng shuānglùqì 272  
xiyānqū 152  
xiyī 293  
xiyī fúwú 101  
xiyī gānyījī 76  
xiyījī 76  
xiyījiān 76  
xiyīlán 76  
xizǎo 72  
xizhǐ 296  
xizhuāng 255  
xuánbì 95  
xuānchuānyè 96  
xuānguà huáxiāng 248  
xuānguàshì wénjiànjiā 173  
xuānlǐ 259  
xuānshèng xiàjiàng 248  
xuānwūyán 288  
xuányá 285  
xuányī 211  
xuánzhuǎn 230  
xuè 287  
xuèbēng 247  
xuèdào 246  
xuèdàowài 247  
xuèhuāsū múzǐ 69  
xuèjiā 112  
xuèlǐjiū 145  
xuēpǐ 67  
xuēpǐdào 68  
xuèshèng 162  
xuèshèngshítáng 168  
xuèshèngsùshè 168  
xuèsōng 296  
xuèwèi 169  
xuèwèipào 169  
xuèxí 162, 163  
xuèxí huódòng 162  
xuèxiào 162, 299  
xuèxiyòngjù 165  
xuèyā 44  
xuèyājī 45  
xuèyú 120  
xūhòushuǐ 73  
xùjiè 168  
xùlǐyà 318
- xūnfēiyú 157  
xūnhuán xūnliàn fā 250  
xūnhuàisài 233  
xūnliàn 250  
xūnròu 118, 157  
xūnyú 143  
xūnzhi 159  
xūnzhide 118, 121, 143  
xùqū 256  
xūruò 321
- Y  
yā 119, 185  
yáchí 50  
yáchí hūlǐ 108  
yādàn 137  
yādào 237  
yágāo 72  
yágēn 50  
yāhuàzhǐ 83  
yājiāo 276  
yājūnbān 50  
yákēyī 50  
yālì 55  
yǎlǐfá 61  
yǎlǐng 250  
yǎlǔjī 187  
yàmà 184  
yàmábù 277  
yàmǎijī 314  
yàmǎijīchǒujú 126  
yàmásūn píngyuán 312  
yàměiniyà 318  
yán 64, 152  
yán 19, 95  
yánbì 301  
yánbō 68, 167  
yáncáo 58  
yāncáo 112, 184  
yánchū 68, 167  
yāncōng 58, 214  
yándōng 284  
yāndǒu 112  
yángcōng 124  
yánggāo 185  
yángguāng 286  
yángguāng míngmèi 286  
yánghuái 110  
yángjiào miànbào 156  
yángjiàodǒu 122  
yángjǐchǎng 183  
yángmáoshān 32  
yángmǎotǎn 74  
yāngmiào 91  
yàngpiàn 271  
yàngqǐping 239  
yángqún 183  
yángshuǐ 52  
yángshuǐ chuāncǐ zhēnduàn 52  
yángtái 59  
yángtáo 128  
yāngū 112  
yángwēi 20  
yāngwòqizuò 250  
yāngyǒng 239  
yāngyú 120  
yāngyúchǎng 183  
yāngzhūchǎng 183
- yānhé 112  
yānhóu 19  
yānhuīgāng 150  
yānjiān 51  
yānjiāng 283  
yānjiāngchí 283  
yānjing 51  
yānjīng 14, 51  
yānjīng hé 51  
yānjiū 169  
yānjiūshèng jiēduàn 169  
yānkē 49  
yánkǒu 300  
yānlèi 51  
yānlǎo 274  
yànmài 130  
yánsè 274  
yánshí 284, 288  
yánshíyuán 84  
yànwú 321  
yànwú bàojǐngqì 95  
yānxiānyè 40  
yānxuè 48  
yānyíng 40  
yānyuán 179, 191  
yánzhe... 320  
yānzhide 118  
yānjiān 292  
yānzǐ 159  
yánzide 121, 129, 137, 143  
yānzǐ 112  
yào 109  
yāo 12  
yàocáo 55, 86  
yàodài 32, 35, 36, 236  
yāodàikǒu 36  
yàodiàn 108  
yāodībù 13  
yāogān 150  
yàogāo 47  
yàogōng zhuànpán 275  
yàogōu 245  
yàogūn yīnyuèhǔ 258  
yàoguò 129, 151  
yàojīshì 108, 189  
yàokòngqì 269  
yàopiàn 109  
yāoròu 121  
yāoshāng 46  
yàoshi 59, 207  
yàowú zhǐliáo 109  
yàoyú 120, 294  
yàoyúchì 120  
yāozhuī 17  
yápiàn 50  
yáshuā 72  
yāsuanqì 68  
yāsuide 132  
yátōng 50  
yáxiàn 50, 72  
yáxuè 120  
yáyí 50, 189  
yáyín 50  
yàzhōu 318  
yázuàn 50  
yè 122, 296  
yēcān 263  
yēcānchāngyī 266
- yècù 110  
yéfēngxīnzǐ 297  
yégēng 297  
yēji 119  
yémén 318  
yèshèng dòngwùyuán 262  
yētí fēngmǐ 134  
yētí liángqì 311  
yèwèi 119  
yèwèiròu 118  
yèwō 13  
yèyán 288  
yèyingchē 266  
yèyínglú 267  
yèzǎo 129  
yèzi 129  
yì 308  
yì jīngguò bāshìxiāodúde 137  
yì kèzhōng 304  
yì xiǎobēi 151  
yìbái 308  
yìbàiwàn 309  
yìbèi 121, 295  
yìbèi 64, 210  
yìbiāopán 201  
yìcéng 104  
yìchéng 174  
yìchú 70  
yìchénghéxiàng quánzǐdòng  
xiàngjī 270  
yìcǐxing niàobù 30  
yìcǐxing tìxūdāo 73  
yìcǐxing xiàngjī 270  
yìcǐxingde 109  
yìdǎlì 316  
yìdǎlì miànshí 158  
yìdǎlì xūnhuòtuǐ 143  
yìdǎlì xiāngcháng 142  
yìdǎn nǎilào 142  
yìdàosù 109  
yìdiǎn'er 320  
yìdòng bǐngchuáng 48  
yìdòng diànhuà 99  
yìfèn 64  
yìfújià 76  
yìfúpái 273  
yìgān rúdòng 233  
yìhòu 304, 320  
yìjià 70  
yìlākè 318  
yìlǎng 318  
yìlǐng 32  
yìliúguān 61  
yìmín 26  
yìn 289  
yìn yóu jiāntóude xīnzhǐ 173  
yīnchǎn 53  
yīnchún 20  
yīndào 20  
yīndàogémó 21  
yīndì 20  
yīndì zhīwù 87  
yīndù 318  
yīndù cǎoyào liáofá 55  
yīndù yáng 313  
yīndùnxīyà 319  
yīndùshìmiànbào 139

- yīnfú 256  
 yíng 273  
 yíng 124, 129, 321  
 yíng 292  
 yíng'ér 23, 30  
 yíng'ér bēi 75  
 yíng'ér biānpén 74  
 yíng'ér chéng 53  
 yíng'ér chuāng 74  
 yíng'ér diàodài 75  
 yíng'ér hūlǐ 74  
 yíng'ér jiān 104  
 yíng'ér jiānshìqì 75  
 yíng'ér liánjiāokǒu 30  
 yíng'ér shǒutào 30  
 yíng'ér shuǐlǎn 74  
 yíng'ér shuǐyī 30  
 yíng'ér xié 30  
 yíng'ér yīwùdài 75  
 yíng'ér yóngpīn 107  
 yíng'ér yùpén 74  
 yíngāo 256  
 yíngbì 97  
 yíngcǎo 297  
 yíngchǐ 310  
 yíngcùn 310  
 yíngdì guānlíchù 266  
 yíngdídēng 267  
 yíngguó 316  
 yíngguóguān 257  
 yíngguó 266  
 yíngjiā 273  
 yíngjiàn 176  
 yíngjide 129  
 yínglǐ 310  
 yíngmiānbāoquān 139  
 yíngmó wài mázui 52  
 yíngmù 79  
 yíngnǎilào 136  
 yíngpán 176  
 yíngshì gǎnlǎnqiú 221  
 yíngshì gǎnlǎnqiú qiūchǎng 221  
 yíngshì jièmojiàng 135  
 yíngshì zǎocān 157  
 yíngsù 297  
 yíngsùfāng 181  
 yíngsùzǐ 138  
 yíngtáng 113  
 yíngtáo 126  
 yíngtáofānqié 124  
 yíngwù 293  
 yíngyǎngpīn 55  
 yíngyòng chéngxù 176  
 yíngzhīhé 311  
 yíngzhilùjiān 194  
 yíngzuǐdòu 131  
 yínháng 96  
 yínháng jīnglǐ 96  
 yínháng shǒuxùfèi 96  
 yínháng zhuǎnzhàng 96  
 yínhángkǎ 96  
 yínhuǒwù 266  
 yiniánshēng (zhīwù) 86  
 yīnjiē 256  
 yīnjīng 21  
 yīnliàng 179, 269  
 yīnliào 107, 144, 156  
 yīnmù 255  
 yīnnáng 21  
 yīnpái 235  
 yínqíng 202, 204, 210  
 yínqínggài 198  
 yīnshǐ 75  
 yīnshuā 275  
 yíntái 173  
 yíntǐ xiàngshàng 250  
 yīnxiāng 176, 268  
 yīnxiàngdiàn 115  
 yīnxiāngjià 268  
 yīnxíng yǎnjīng 51  
 yīnxíng yǎnjīng hé 51  
 yīnyuē 162  
 yīnyuē fēnggé 259  
 yīnyuēhuì 255, 258  
 yīnyuējiā 191  
 yīnyuējù 255  
 yīnyuēxiéyuán 169  
 yīnzuoyuán 255  
 yīpēngtiāode 130  
 yīqiān 309  
 yīshìliè 318  
 yīsháoliàng 149  
 yīshēng 45, 189  
 yīshìníngsuǒ kāfēi 148  
 yīshù 162  
 yīshù tīcāo 235  
 yīshùguān 261  
 yīshùpīndiàn 115  
 yīshùshì 169  
 yīshùnhuái 98  
 yīwàn 309  
 yīwúlǎn 76  
 yīxié 320  
 yīxuē 169  
 yīyōngdēng 50  
 yīyōngdiàodài 46  
 yīyōngjiābān 47  
 yīyōngqián 167  
 yīyuàn 48  
 yīyuē 306  
 yīzàng 18  
 yīzhí 91  
 yīzhí 320  
 yīzhíchǎn 89  
 yīzǐ 64  
 yīzǐtuī 64  
 yòng shāzhǐ dǎmó 82  
 yòng yáxiàn jīchí 50  
 yōngdào 238  
 yōnggǎn zhīchēng 91  
 yōngjīn 97  
 yōngjù 238  
 yōngkù 238  
 yōngmào 238  
 yōngyī 238  
 yōngzǐ 239  
 yóu 134, 142, 199  
 yòu 260  
 yóucài 123  
 yóucàizǐ 184  
 yòucèjiāshǐ 201  
 yóuchuó 98  
 yóudài 98, 190  
 yóudiyuán 98, 190  
 yóuér 30  
 yōuguāngzé 83, 271  
 yōuguǎndiànché 196, 208  
 yōuhéshuǐguó 126  
 yóuhuà yǎnliào 274  
 yǒuji fèiwù 61  
 yǒujià zhèngquàn zùhé 97  
 yǒujide 91, 118, 122  
 yóujú 98  
 yóujú zhīyuán 98  
 yóukè 260  
 yóulǎn shèngdì 50  
 yóulǎnché 197  
 yóulǎnxīn 261  
 yóulèchǎng 263  
 yóulèyuán 262  
 yóuliàngbiào 201  
 yōulǚ 25  
 yóulún 215  
 yóumén 200, 204  
 yómò 275  
 yóupiào 98, 112  
 yóuqí 83  
 yóuqí gǔntǒng 83  
 yóuqipán 83  
 yóuqitǒng 83  
 yóuqù 321  
 yóushēng zhínénglǐde 50  
 yóusūdiànxīn 140, 149  
 yóutàijiào huítáng 300  
 yóutáo 126  
 yóuting 215  
 yóutǒng 99  
 yóuwǎiyè 229  
 yóuxi 75, 272, 273  
 yóuxi wéilán 75  
 yóuxiàn diànshì 269  
 yóuxiāng 203  
 yóuxiào qiàxiàn 109  
 yóuxijiemù 178  
 yóuxing 39, 41  
 yóuxíng 27  
 yóuyǎng yùndòng 250  
 yóuyǒng 238  
 yóuyǒng xuǎnshǒu 238  
 yóuyǒngchǐ 101, 238, 250  
 yóuyǒngjīng 238  
 yóuyǒngquān 265  
 yóuyǒngyī 265  
 yóuyú 121, 295  
 yóuzhá 159  
 yóuzhèngbiānmǎ 98  
 yòuzhǐ 50  
 yóuzǐ 143  
 yóuzǐ 98  
 yóuzui 181  
 yú 107, 155, 120  
 yú 287  
 yú'èrdài 291  
 yuǎndài 233  
 yuǎndīng 300  
 yuǎndīng 188  
 yuǎndīng 250  
 yuǎngōng 175  
 yuánguī 165  
 yuánhào 257  
 yuánjù 78  
 yuánli 130  
 yuánlíng 33  
 yuǎnshì 51  
 yuǎnwēi 110  
 yuǎnxīn 164  
 yuánxíng 164  
 yuǎnyángkèlún 214  
 yuǎnyī 90  
 yuǎnyī gōngjù 88  
 yuǎnyī shèjì 91  
 yuǎnyī shǒutào 89  
 yuǎnyī yòngpīndiàn 115  
 yuánzhōu 164  
 yuánzhuitǐ 164  
 yuánzhūtǐ 164  
 yuǎnzú 263  
 yúchābūyù 245  
 yúchuán 217  
 yùdīng 168  
 yuè 306  
 yuèchí 254  
 yuèdàn 318  
 yuèdùdēng 210  
 yuèduì 254, 256  
 yuèfú 23  
 yuègūiyè 133  
 yuèguó 320  
 yuèhuì 175  
 yuèjīng 20  
 yuèlǎnshì 168  
 yuèmù 23  
 yuèrán 318  
 yuèpǔ 255, 256  
 yuèqì 256, 258  
 yuèqiú 280  
 yuèwèi 223  
 yuèyè huàxuē 247  
 yuèyémótuō 205  
 yuèzhàng'àisài 243  
 yuèzhàngshí 288  
 yúfán 188  
 yúgān 244  
 yúgāng 217  
 yúgāng 72  
 yúgōu 244  
 yúhángyuán 281  
 yújia 54  
 yújiaxué 286  
 yújīn 73  
 yújīng 181  
 yújīnxiāng 111  
 yúlè 294  
 yúlín 285  
 yúlǒu 245  
 yúmáo 293  
 yúmáoqiú 231  
 yúmì 130, 184  
 yúmíapán 89  
 yúmímiānbāo 139  
 yúmín 189  
 yúmíyóu 135  
 yún 287  
 yúnbó 128  
 yúnychēyào 109  
 yúndào 25  
 yùndòng xiōngzhào 35  
 yùndòngchǎng 168, 234  
 yùndòngfú 31  
 yùndòngkù 33  
 yùndòngshān 33  
 yùndòngxié 31, 37, 250  
 yùndòngyuán 191  
 yùndǒu 76  
 yūnī 85  
 yúnmù 289  
 yúnqíú 227  
 yùntàng 76  
 yùnyībān 76  
 yùpáo 73  
 yúpiàn 121  
 yúróngbèi 71  
 yúshāndǒu 297  
 yúshāng 46  
 yúshí 288  
 yúshì 72, 266  
 yúshì fānghuádàn 72  
 yúshù 296  
 yúshuā 198  
 yútou 124  
 yúwǎng 217  
 yúxiàn 244  
 yúxiàn 162  
 yúyī 31, 32, 245, 267  
 yúyigǎnlán 123  
 yúyīn xūnxī 99  
 yúyīngshì 74  
 yúyīngxiāng 53  
 yúyuē 45  
 yúyuèjé 27  
 yúzhōu 280  
 yúzhòukōngjiān 280  
 Z  
 zǎbàntāngguó 113  
 zǎcǎo 86  
 zài 320  
 zài...duìmiàn 320  
 zài...fùjìn 320  
 zài...hòumiàn 320  
 zài...lǐ 320  
 zài...lǐmiàn 320  
 zài...pángbiān 320  
 zài...qiánmiàn 320  
 zài...shàng 320  
 zài...shàngfāng 320  
 zài...shàngmiàn 320  
 zài...wài 320  
 zài...wàimiàn 320  
 zài...xiàfāng 320  
 zài...xiàmiàn 320  
 zài...zhìhòu 320  
 zài...zhìjiān 320  
 zài...zhìqián 320  
 zài...zhìshàng 320  
 zài...zhōuwéi 320  
 zāibōpiàn 167  
 zāiláiyíci 255  
 zāipéi 91  
 zāiwútái 167  
 zàixiàn 177  
 zàizhōngqìchē 194  
 zànbìyà 317  
 zāng 321  
 zànghónghuā 132  
 zànglǐ 26  
 zāngyiwù 76  
 zàntíng 220, 269  
 zǎo 305, 320



- zāocān 64, 156  
 zāocān màipiàn 107  
 zāocānpán 101  
 zāocānzhuō 156  
 zāochānde 52  
 zāochén 305  
 záozi 81, 275  
 zázhi 107, 112, 168  
 zhàdè 317  
 zhài 321  
 zhāichú kúhuà 91  
 zhāiyuè 27  
 zhājī 155  
 zhāmèng 295  
 zhāndòuji 211  
 zhàng'ài 243  
 zhàng'aisai 243  
 zhàngdān 152  
 zhàngfú 22  
 zhànggū 17  
 zhànghào 96  
 zhàngláng 295  
 zhàngpéng 267  
 zhàngpénggān 266  
 zhàngshàng diànnǎo 175  
 zhāngyú 121, 295  
 zhānjiàn 215  
 zhānlǎn 261  
 zhānpin 261  
 zhànqiáo 217  
 zhàntái 208  
 zhàntáihào 208  
 zhànxiàn 99  
 zhào 291, 293  
 zhàomíng 178  
 zhàomíngdàn 240  
 zhàopái 104  
 zhàoshān 38  
 zhāoshèngbān 168  
 zhàoxiàng 271  
 zhàoxiàng qicáidiàn 115  
 zhàoxiàngjī 260  
 zhàozé 285  
 zhàshùpiàn 151  
 zhēbì jiāodài 83  
 zhédíeshì yíng'érché 75  
 zhei 273  
 zhěilǐ 320  
 zhēn 276  
 zhēnbǎn 276  
 zhēndiàn 276  
 zhēndòng 283  
 zhēnduàn 45  
 zhèng 165  
 zhèng 67  
 zhèngcān 158  
 zhèngcān yòngpán 165  
 zhèngcūmàifēn 130  
 zhèngfāngxíng 164  
 zhènggū liáofā 54  
 zhèngjī 167  
 zhèngjiù 181  
 zhènglǐ 130  
 zhènglǐ chuāngpù 71  
 zhèngqíjīché 208  
 zhèngquàn 97  
 zhèngquàn jiāoyisùo 97  
 zhèngquè 321  
 zhèngrén 180  
 zhèngshǒu 231  
 zhèngtíng qiánpái zuòwèi 254  
 zhèngwú 305  
 zhèngxíngwàikè 49  
 zhèngzhī 91  
 zhèngzhixué 169  
 zhèngzhuāng 34  
 zhēnjiào 277  
 zhēnjiào xuānzéqì 276  
 zhènjīng 25  
 zhènjīngjī 109  
 zhēnjiù 55  
 zhēnlíoshì 45  
 zhēnrényóu 134  
 zhěnsuǒ 48  
 zhěntàn 94  
 zhěntào 71  
 zhěntóu 70  
 zhěntóu 109  
 zhēnxiānguāng 276  
 zhēnyèshù 86  
 zhènyù 286  
 zhènzhǔ xiàngliàn 36  
 zhēnzi 129  
 zhēshāng 46  
 zhétí 82  
 zhèxīgiāo 40  
 zhéxué 169  
 zhēyángmào 30, 265  
 zhēyángpéng 75, 148  
 zhēyángsān 148, 264  
 zhēzhēn 295  
 zhézhì 275  
 zhi 14, 293  
 zhibǎn 275  
 zhibānzhixíng 275  
 zhibi 97  
 zhibiān 277  
 zhibīngshì 67  
 zhibō 178  
 zhibù 277  
 zhibùjī 277  
 zhícháng 21  
 zhíchēnggān 89, 91  
 zhíchí 165  
 zhídài 207  
 zhídào... 320  
 zhídòngyè róngqì 202  
 zhífá 39  
 zhífú 94, 189  
 zhígú 17  
 zhíguānjié 15  
 zhiháng 260  
 zhíhé 172, 311  
 zhihui 256  
 zhihuibàng 256  
 zhihuità 215  
 zhihuitài 256  
 zhijia 15  
 zhijia 88, 205, 207, 267  
 zhijia hùli 41  
 zhijiacuò 41  
 zhijiaodào 41  
 zhijiajiàn 41  
 zhijiyóu 41  
 zhijie jieji 96  
 zhijièwàiqù 223, 226  
 zhijin 108  
 zhijing 164  
 zhijinhe 70  
 zhikéyào 108  
 zhili 315  
 zhiliáoshì 55  
 zhiliudiàn 60  
 zhīmacài 123  
 zhīmāyóu 134  
 zhīmāzǐ 131  
 zhīmíndì 315  
 zhīnánzhēn 240, 312  
 zhǐpái 273  
 zhipiānrén 254  
 zhipiào 96  
 zhipiào cúngēn 96  
 zhipiàobù 96  
 zhìqiú 227  
 zhíshēng fěiji 211  
 zhītóngyào 47, 109  
 zhítuyuán 191  
 zhíwén 94  
 zhíwù 296  
 zhíwù rǒushùnjī 76  
 zhíwùyóu 135  
 zhixī 47  
 zhíxing bīnggān 141  
 zhíyá ànmó 54  
 zhíyá liáofā 55  
 zhíyàng 276  
 zhíyè 127  
 zhíyèr 190  
 zhíyèyī 188  
 zhiyin 260  
 zhízhāngpéng 266  
 zhízhū 295  
 zhízuò 187  
 zhízuò miànbào 138  
 zhòng 321  
 zhōngbiāo 62, 304  
 zhōngbō 179  
 zhōngchǎng 224  
 zhōngdiǎn xiàn 234  
 zhōngdú 46  
 zhōngfēi gònghéguó 317  
 zhōngfēng 44  
 zhōnggēngjī 182  
 zhōngguó 318  
 zhōngguósùwùshù 236  
 zhōngjiāncéng 286  
 zhōngjīnmiànfēn 139  
 zhōngjīnshùiyuógǔn 259  
 zhōnglǐ 280  
 zhōngliàng xùnlìàn 250  
 zhōngliúké 49  
 zhōngpǔ lùmiàn 187  
 zhōngquān 222, 224, 226  
 zhōngtiān 256  
 zhōngwàiyì 228  
 zhōngxiàn 226  
 zhōngxíng 39  
 zhōngyāngchédào 194  
 zhōngyāngchǔlǐqì 176  
 zhōngyāngfēnchédài 194  
 zhōngzhī 183  
 zhōngzhī 15  
 zhòngzhiyuán 183  
 zhōngzi 88, 122, 130, 131  
 zhǒu 13  
 zhǒuméi 25  
 zhǒumó 306  
 zhǒuwén 15  
 zhǒuyuè 305  
 zhù 300  
 zhù 185  
 zhuan 187  
 zhuān yòngyùshì 100  
 zhuānbidào 163  
 zhuāng'ěr 245  
 zhuāngjia 183  
 zhuāngrú 76  
 zhuāngshì 141  
 zhuāngshijìxiàn 63  
 zhuāngshipèiliào 155  
 zhuāngshiyìshù fēnggè 301  
 zhuāngxìàn 159  
 zhuāngxiū 82  
 zhuānkè yìshēng 49  
 zhuānshēn 238  
 zhuānsùbiào 201  
 zhuānxiàngdēng 198, 204  
 zhuānyì 172  
 zhuānzhēn 49  
 zhuāwò 237  
 zhūbào zhizuò 275  
 zhūbàojiàng 188  
 zhūcài 153  
 zhūcáipàn 222  
 zhūchǎn 53  
 zhūchàng 258  
 zhūchǎnshì 53  
 zhūchí 174  
 zhūchú 152  
 zhūchú 152  
 zhūding méiliáng 301  
 zhūfān 240  
 zhūfèi 67  
 zhūguān 174  
 zhuixínggélidūn 187  
 zhújiàn 236  
 zhújìdàn 137, 157  
 zhújīng 297  
 zhújuàn 185  
 zhùlǐ 24  
 zhùlùkǒu 194  
 zhǔnquèdì 320  
 zhǔnshí 305  
 zhuōbù 64  
 zhuólù 211  
 zhuomiàn 177  
 zhuōmiànbèijīng 177  
 zhuómuniào 292  
 zhūozǐ 148  
 zhǔquán guójia 315  
 zhūrén 64  
 zhūròu 118  
 zhùshè 48  
 zhùshèqì 109, 167  
 zhùshuǐ 67  
 zhùshuixiāng 61  
 zhúsūn 122  
 zhùtí gōngyuán 262  
 zhùtūiqì 281  
 zhūxuè xiāngcháng 157  
 zhúzi 86  
 zǐ 128  
 zidiān 163  
 zidòng 200  
 zidòng fúti 104  
 zidòng mén 196  
 zidòng tiáowénqì 61  
 zidòng tīshìjī 179  
 zidòngxī chēzhàn 199  
 zifāfēn 139  
 zigōng 52  
 zigōng 52  
 zigōng 20  
 zigōngjīng 20, 52  
 zigōngtuō 21  
 zihào 25  
 zihuāmùxu 184  
 zijie 176  
 zilái shuǐ 144  
 ziluólan 110  
 zimèi 22  
 zipái 272  
 ziránkèxué 162  
 ziránliáofā 55  
 zisè 274  
 zishuǐjīng 288  
 zití 177  
 zīwàixiàn 286  
 zīwàixiàn yùchuáng 41  
 ziwèi 237  
 zixin 25  
 zixíngché 206  
 zixíngché zhíjià 207  
 zixíngchédào 206  
 ziyóutícao 235  
 ziyóuyǒng 239  
 zizhucān 152  
 zizhuzāocān 156  
 zōngbù 175  
 zōnggōngsī 175  
 zōnghésè pífú 41  
 zōnghuì sānmíngzhì 155  
 zōngjīnglǐ 175  
 zōnglú 86  
 zōnglùshù 296  
 zōnglùxīn 122  
 zōngmáo 242, 291  
 zōngshēn 165  
 zóuláng 168, 210  
 zóumíngqǔ 256  
 zóuqì 273  
 zuànjìatōu 78  
 zuànkǒng 79  
 zuànkǒngqì 80  
 zuànshí 288  
 zuàntōu 80  
 zūchēchù 213  
 zúdǎng 227  
 zudi fānshè liáofā 54  
 zúfú 22  
 zúfúmu 23  
 zúgōng 15  
 zúhéchōuti 172  
 zú 14  
 zuifān 181  
 zuìhòu 320  
 zuixíng 94  
 zúmù 22  
 zūnyú 120  
 zuō 260

zuǒcèjiàshǐ 201  
zuògǎn 206  
zuótiān 306, 320  
zuǒwàiyè 228  
zuòwèi 64, 209, 210, 254  
zuòwèi'ānpái 254  
zuòwén 163  
zuòyè 163  
zuòyí tóuzhěn 200  
zúqú 222  
zúqú qiúyī 31, 222  
zúqú qiúyuán 222  
zúqúchǎng 222  
zūyòng 58



## 英文索引 yīngwén suǒyǐn • English index

- A**  
 à la carte 152  
 abdomen 12  
 abdominals 16  
 above 320  
 abseiling 248  
 acacia 110  
 accelerator 200  
 access road 216  
 accessories 36, 38  
 accident 46  
 account number 96  
 accountant 97, 190  
 accounts department 175  
 accused 180  
 ace 230, 273  
 Achilles tendon 16  
 acorn squash 125  
 acquaintance 24  
 acquitted 181  
 across 320  
 acrylic paints 274  
 actions 237, 229, 227, 233, 183  
 activities 263, 245, 162, 77  
 actor 254, 191  
 actors 179  
 actress 254  
 acupressure 55  
 acupuncture 55  
 Adam's apple 19  
 add v 165  
 address 98  
 adhesive tape 47  
 adjustable spanner 80  
 admissions 168  
 admitted 48  
 aduki beans 131  
 adult 23  
 advantage 230  
 adventure 255  
 advertisement 269  
 aerate v 91  
 aerobics 251  
 Afghanistan 318  
 Africa 317  
 after 320  
 afternoon 305  
 aftershave 73  
 aftersun 108  
 agate 289  
 agenda 174  
 aikido 236  
 aileron 210  
 air bag 201  
 air conditioning 200  
 air cylinder 239  
 air filter 202, 204  
 air letter 98  
 air mattress 267  
 air stewardess 190  
 air supply 199  
 air vent 210  
 aircraft 210  
 aircraft carrier 215  
 airliner 210, 212  
 airport 212  
 aisle 106, 168, 210, 254  
 alarm clock 70  
 Alaska 314  
 Albania 316  
 alcoholic drinks 145  
 alfalfa 184  
 Algeria 317  
 allergy 44  
 alley 298  
 alligator 293  
 allspice 132  
 almond 129  
 almond oil 134  
 almonds 151  
 along 320  
 alpine 87  
 alpine skiing 247  
 alternating current 60  
 alternative therapy 54  
 alternator 203  
 altitude 211  
 aluminium 289  
 Amazonia 312  
 ambulance 94  
 American football 220  
 amethyst 288  
 amniocentesis 52  
 amniotic fluid 52  
 amount 96  
 amp 60  
 amphibians 294  
 amplifier 268  
 anaesthetist 48  
 anchor 214, 240  
 Andes 312  
 Andorra 316  
 angle 164  
 angler 244  
 Angola 317  
 angry 25  
 animals 292, 294  
 animated film 255  
 ankle 13, 15  
 ankle-length 34  
 anniversary 26  
 annual 86, 307  
 anorak 31, 33  
 answer 163  
 answer v 99, 163  
 answering machine 99  
 ant 295  
 antenna 52  
 antena 295  
 antifreeze 199, 203  
 Antigua and Barbuda 314  
 anti-inflammatory 109  
 antique shop 114  
 antiseptic 47  
 antiseptic wipe 47  
 anti-wrinkle 41  
 antler 291  
 apartment block 298  
 apéritif 153  
 aperture dial 270  
 apex 165  
 appeal 181  
 appearance 30  
 appendix 18  
 applaud v 255  
 apple 126  
 apple corer 68  
 apple juice 149  
 appliances 66  
 application 176  
 appointment 45, 175  
 apricot 126  
 April 306  
 apron 30, 50, 69, 212  
 APS camera 270  
 aquamarine 288  
 Arabian Sea 313  
 arable farm 183  
 arc 164  
 arch 15, 85, 301  
 archery 249  
 architect 190  
 architecture 300  
 architrave 301  
 Arctic circle 283  
 Arctic Ocean 312  
 area 165, 310  
 areas 299  
 arena 243  
 Argentina 315  
 arithmetic 165  
 arm 13  
 armband 238  
 armchair 63  
 Armenia 318  
 armpit 13  
 armrest 200, 210  
 aromatherapy 55  
 around 320  
 arrangements 111  
 arrest 94  
 arrivals 213  
 arrow 249  
 art 162  
 art college 169  
 art deco 301  
 art gallery 261  
 art nouveau 301  
 art shop 115  
 artery 19  
 artichoke 124  
 artist 274  
 arts and crafts 274, 276  
 ash 283  
 ashtray 150  
 Asia 318  
 assault 94  
 assistant 24  
 assisted delivery 53  
 asteroid 280  
 asthma 44  
 astigmatism 51  
 astronaut 281  
 astronomy 281  
 asymmetric bars 235  
 at 320  
 athlete 234  
 athletics 234  
 Atlantic Ocean 312  
 atmosphere 282, 286  
 atrium 104  
 attachment 177  
 attack 220  
 attack zone 224  
 attend v 174  
 attic 58  
 attractions 261  
 aubergine 125  
 auburn 39  
 audience 254  
 August 306  
 aunt 22  
 aurora 286  
 Australasia 319  
 Australia 319  
 Austria 316  
 autocue 179  
 automatic 200  
 automatic door 196  
 autumn 31, 307  
 areas 299  
 avenue 299  
 avocado 128  
 awning 148  
 axe 95  
 axle 205  
 ayurveda 55  
 Azerbaijan 318  
**B**  
 baby 23, 30  
 baby bath 74  
 baby care 74  
 baby changing facilities 104  
 baby monitor 75  
 baby products 107  
 baby sling 75  
 babygro 30  
 back 13  
 back brush 73  
 back seat 200  
 backboard 226  
 backdrop 254  
 backgammon 272  
 backhand 231  
 backpack 31, 37, 267  
 backstroke 239  
 backswing 233  
 bacon 118, 157  
 bad 321  
 badge 94  
 badminton 231  
 bag 311  
 bagel 139  
 baggage reclaim 213  
 baggage trailer 212  
 bags 37  
 baguette 138  
 Bahamas 314  
 bail 181  
 bait 244  
 bait v 245  
 bake v 67, 138  
 baked 159  
 baker 139  
 baker's 114  
 bakery 107, 138  
 baking 69  
 baking tray 69  
 balance wheel 276  
 balcony 59, 254  
 bald 39  
 bale 184  
 Balearic Islands 316  
 ball 15, 75, 221, 224, 226, 228, 230  
 ballboy 231  
 ballet 255  
 balsamic vinegar 135  
 Baltic Sea 313  
 bamboo 86, 122  
 banana 128  
 bandage 47  
 Bangladesh 318  
 banister 59  
 bank 96, 284  
 bank charge 96  
 bank manager 96  
 bank transfer 96  
 bap 139  
 bar 150, 152, 250, 256, 311  
 bar code 106  
 bar counter 150  
 bar mitzvah 26  
 bar snacks 151  
 bar stool 150  
 barb 244  
 Barbados 314  
 barbecue 267  
 barber 39, 188  
 bark 296  
 barley 130, 184  
 barman 191  
 barn 182  
 baroque 301  
 bars 74  
 bartender 150  
 basalt 288  
 base 164, 229  
 base station 99  
 baseball 228  
 baseline 230  
 baseman 228  
 basement 58

- basil 133  
 basin 50  
 basket 106, 207, 226  
 basket of fruit 126  
 basketball 226  
 basketball player 226  
 basque 35  
 bass clarinet 257  
 bass clef 256  
 bass guitar 258  
 bass guitarist 258  
 bassoon 257  
 bat 225, 228, 231, 290  
 bat v 225, 229  
 bath mat 72  
 bath towel 73  
 bathrobe 73  
 bathroom 72  
 bathtub 72  
 baton 235, 256  
 batsman 225  
 batter 228  
 batteries 260  
 battery 167, 202  
 battery pack 78  
 battleship 215  
 bay leaf 133  
 bayonet fitting 60  
 be born v 26  
 beach 264  
 beach bag 264  
 beach ball 265  
 beach hut 264  
 beach towel 265  
 beach umbrella 264  
 beaker 167  
 beam 186, 235  
 bean sprout 122  
 beans 131, 144  
 bear 291  
 beat 259  
 beauty 40, 105  
 beauty treatments 41  
 bed 70  
 bed and breakfast 101  
 bed linen 71  
 bedding 74  
 bedroom 70  
 bedside lamp 70  
 bedside table 70  
 bedspread 70  
 bee 295  
 beech 296  
 beef 118  
 beer 145, 151  
 beer tap 150  
 beetle 295  
 beetroot 125  
 before 320  
 beginning 321  
 behind 320  
 Belarus 316  
 Belgium 316  
 Belize 314  
 bell 197  
 below 320  
 belt 32, 36, 236  
 bench 250, 262  
 Benin 317  
 berry 296  
 beside 320  
 bet 273  
 between 320  
 beyond 320  
 Bhutan 318  
 biathlon 247  
 bib 30  
 bicep curl 251  
 biceps 16  
 bicycle 206  
 bidet 72  
 biennial 86  
 bifocal 51  
 big toe 15  
 bike rack 207  
 bikini 264  
 bill 152, 293  
 binoculars 281  
 biology 162  
 biplane 211  
 birch 296  
 bird watching 263  
 birds 292  
 birth 52  
 birth weight 53  
 birth certificate 26  
 birthday 27  
 birthday cake 141  
 birthday candles 141  
 birthday party 27  
 biscuit 113  
 biscuits 141  
 bishop 272  
 bit 242  
 bit brace 78  
 bite 46  
 bite v 245  
 bitter 124, 145  
 black 39, 272, 274  
 black belt 237  
 black coffee 148  
 black hole 280  
 black olive 143  
 black pudding 157  
 Black Sea 313  
 black tea 149  
 blackberry 127  
 blackboard 162  
 blackcurrant 127  
 black-eyed beans 131  
 bladder 20  
 blade 60, 66, 78, 89  
 blanket 71, 74  
 blazer 33  
 bleach 77  
 blender 66  
 blister 46  
 block 237  
 block v 227  
 block of flats 59  
 blonde 39  
 blood pressure 44  
 blood pressure gauge 45  
 blood test 48  
 blouse 34  
 blow dry v 38  
 blow out v 141  
 blowhole 290  
 blue 274  
 blue cheese 136  
 bluebells 297  
 blueberry 127  
 blues 259  
 blusher 40  
 board 241  
 board v 217  
 board games 272  
 boarding pass 213  
 bob 39  
 bobbin 276  
 bobsleigh 247  
 body 12  
 body lotion 73  
 body systems 19  
 bodywork 202  
 boil v 67  
 boiled egg 137, 157  
 boiled sweets 113  
 boiler 61  
 Bolivia 315  
 bollard 214, 298  
 bolt 59  
 bomber 211  
 bone 17, 119, 121  
 bone meal 88  
 boned 121  
 bongos 257  
 bonnet 198  
 book 168  
 book a flight v 212  
 book shop 115  
 bookshelf 63, 168  
 boom 95, 240  
 booster 281  
 boot 198, 220, 223  
 booties 30  
 bored 25  
 borrow v 168  
 Bosnia and Herzegovina 316  
 Botswana 317  
 bottle 61, 75, 135, 311  
 bottle opener 68, 150  
 bottled foods 134  
 bottled water 144  
 bottom tier 141  
 bounce v 227  
 boundary line 225  
 bouquet 35, 111  
 bouquet garni 132  
 bout 237  
 boutique 115  
 bow 240, 249  
 bow tie 36  
 bowl 61, 65, 112  
 bowl v 225  
 bowler 225  
 bowling 249  
 bowling ball 249  
 box 254  
 box file 173  
 box of chocolates 113  
 box of tissues 70  
 box office 255  
 boxer shorts 33  
 boxercise 251  
 boxing 236  
 boxing gloves 237  
 boxing ring 237  
 boy 23  
 boyfriend 24  
 bra 35  
 brace 50  
 bracelet 36  
 brain 19  
 brake 200, 204, 206  
 brake v 207  
 brake block 207  
 brake fluid reservoir 202  
 brake lever 207  
 brake pedal 205  
 bran 130  
 branch 175, 296  
 brandy 145  
 brass 256  
 Brazil 315  
 brazil nut 129  
 bread 157  
 bread knife 68  
 bread roll 143  
 breadcrumbs 139  
 breadfruit 124  
 breads 138  
 break a record v 234  
 break waters v 52  
 breakdown 203  
 breakfast 64, 156  
 breakfast buffet 156  
 breakfast cereals 107  
 breakfast table 156  
 breakfast tray 101  
 breast 12, 119  
 breast bone 17  
 breast pump 53  
 breastfeed v 53  
 breaststroke 239  
 breathing 47  
 breech 52  
 brick 187  
 bridge 15, 214, 258, 273, 300  
 bridle 242  
 bridle path 263  
 brie 142  
 briefcase 37  
 briefs 33, 35  
 brioche 157  
 broad bean 122  
 broad beans 131  
 broadcast 179  
 broadcast v 178  
 broccoli 123  
 brochure 175  
 brogue 37  
 bronze 235  
 brooch 36  
 broom 77  
 broth 158  
 brother 22  
 brother-in-law 23  
 browband 242  
 brown 274  
 brown bread 139, 149  
 brown flour 138  
 brown lentils 131  
 brown rice 130  
 browse v 177  
 browser 177  
 bruise 46  
 Brunei 319  
 brunette 39  
 brush 38, 40, 77, 83, 274  
 brush v 38, 50  
 brussel sprout 122  
 bubble bath 73  
 bucket 77, 82, 265  
 buckle 36  
 bud 111, 297  
 buffet 152  
 buggy 232  
 build v 186  
 builder 186, 188  
 building site 186  
 buildings 299  
 built-in wardrobe 71  
 bulb 86  
 Bulgaria 316  
 bull 185  
 bulldog clip 173  
 bull-nose pliers 80  
 bulls-eye 273  
 bumper 74, 198  
 bun 39, 140, 155  
 bunch 111  
 bungalow 58  
 bungee jumping 248  
 bunker 232  
 bunsen burner 166  
 buoy 217  
 bureau de change 97  
 burger 154  
 burger bar 154  
 burger meal 154  
 burglar alarm 58  
 burglary 94  
 Burkina Faso 317  
 Burma (Myanmar) 318  
 burn 46  
 burner 67  
 Burundi 317  
 bus 196  
 bus driver 190  
 bus shelter 197  
 bus station 197  
 bus stop 197, 299  
 bus ticket 197  
 buses 196  
 business 175  
 business class 211  
 business deal 175  
 business lunch 175  
 business partner 24  
 business suit 32  
 business trip 175  
 businessman 175  
 businesswoman 175  
 butcher 118, 188  
 butcher's 114  
 butter 137, 156  
 butter beans 131  
 buttercup 297  
 butterfly 239, 295



- buttermilk 137  
 butternut squash 125  
 buttock 13, 16  
 button 32  
 buttonhole 32  
 buttress 301  
 by 320  
 by airmail 98  
 bytes 176
- C**  
 cab 95  
 cabbage 123  
 cabin 210, 214  
 Cabinda 317  
 cabinet 66  
 cable 79, 207  
 cable car 246  
 cable television 269  
 cactus 87  
 caddy 233  
 caesarean section 52  
 café 148, 262  
 cafetière 65  
 cake shop 114  
 cake tin 69  
 cakes 140  
 calcite 289  
 calcium 109  
 calculator 165  
 calendar 306  
 calf 13, 16, 185  
 call button 48  
 calyx 297  
 cam belt 203  
 Cambodia 318  
 camcorder 260, 269  
 camel 291  
 camembert 142  
 camera 178, 260, 270  
 camera case 271  
 camera crane 178  
 camera shop 115  
 cameraman 178  
 Cameroon 317  
 camisole 35  
 camomile tea 149  
 camp v 266  
 camp bed 266  
 campari 145  
 camper van 266  
 campfire 266  
 camping 266  
 camping stove 267  
 campsite 266  
 campus 168  
 can 145, 311  
 can opener 68  
 Canada 314  
 canary 292  
 candied fruit 129  
 candle 63  
 cane 91  
 canes 89  
 canine 50  
 canned drink 154  
 canoe 214  
 canoeing 241
- canter 243  
 canvas 274  
 cap 21, 36, 238  
 capacity 311  
 cape gooseberry 128  
 capers 143  
 capital 315  
 capoeira 237  
 capsula v 241  
 capsule 109  
 captain 214  
 capuccino 148  
 car 198, 200  
 car accident 203  
 car hire 213  
 car park 298  
 car stereo 201  
 car wash 198  
 caramel 113  
 caravan 266  
 caraway 131  
 caress 27  
 card phone 99  
 card slot 97  
 cardamom 132  
 cardboard 275  
 cardigan 32  
 cardiology 49  
 cardiovascular 19  
 cards 273  
 cargo 216  
 Caribbean Sea 312  
 carnation 110  
 carnival 27  
 carousel 212  
 carpenter 188  
 carpentry bits 80  
 carpet 71  
 carriage 208  
 carriage race 243  
 carrier 204  
 carrot 124  
 carrycot 75  
 cartilage 17  
 carton 311  
 cartoon 178  
 carve v 79  
 carving fork 68  
 case 51  
 cash v 97  
 cash machine 97  
 cashewnut 129  
 cashewnuts 151  
 cashier 96, 106  
 casino 261  
 Caspian Sea 313  
 cassava 124  
 casserole dish 69  
 cassette player 269  
 cassette tape 269  
 cast 254  
 cast v 245  
 castle 300  
 casual 34  
 casual wear 33  
 cat 290  
 catalogue 168  
 catamaran 215
- cataract 51  
 catch v 220, 227, 229, 245  
 catcher 229  
 caterpillar 295  
 cathedral 300  
 catheter 53  
 cauliflower 124  
 cave 284  
 CD player 268  
 cedar 296  
 ceiling 62  
 celebration 140  
 celebration cakes 141  
 celebrations 27  
 celeriac 124  
 celery 122  
 cell 181  
 cello 256  
 cement 186  
 cement mixer 186  
 centimetre 310  
 centipede 295  
 Central African Republic 317  
 central processing unit 176  
 central reservation 194  
 centre 164  
 centre circle 222, 224, 226  
 centre field 228  
 centre line 226  
 centreboard 241  
 century 307  
 ceramic hob 66  
 cereal 130, 156  
 cervical vertebrae 17  
 cervix 20, 52  
 Chad 317  
 chain 36, 206  
 chair 64  
 chair v 174  
 chairlift 246  
 chalk 85, 162, 288  
 chamber 283  
 champagne 145  
 championship 230  
 change v 209  
 change a wheel v 203  
 change channel v 269  
 change gear v 207  
 changing bag 75  
 changing mat 74  
 changing room 104  
 channel 178  
 charcoal 266, 275  
 charge 94, 180  
 chart 48  
 chassis 203  
 check-in v 212  
 check-in desk 213  
 checkout 106  
 check-up 50  
 cheddar 142  
 cheek 14  
 cheerleader 220  
 cheese 136, 156  
 chef 152, 190  
 chef's hat 190  
 chemist 108  
 chemistry 162
- cheque 96  
 chequebook 96  
 cherry 126  
 cherry tomato 124  
 chess 272  
 chessboard 272  
 chest 12  
 chest of drawers 70  
 chest press 251  
 chestnut 129  
 chewing gum 113  
 chick 185  
 chick peas 131  
 chicken 119, 185  
 chicken burger 155  
 chicken coop 185  
 chicken nuggets 155  
 chicken pox 44  
 chicory 122  
 child 23, 31  
 child lock 75  
 child seat 198, 207  
 childbirth 53  
 children 23  
 children's clothing 30  
 children's department 104  
 children's ward 48  
 child's meal 153  
 Chile 315  
 chili 143  
 chill 44  
 chilli 124, 132  
 chimney 58  
 chin 14  
 China 318  
 china 105  
 chip v 233  
 chipboard 79  
 chiropractic 54  
 chisel 81, 275  
 chives 133  
 chocolate 113  
 chocolate bar 113  
 chocolate cake 140  
 chocolate chip 141  
 chocolate coated 140  
 chocolate milkshake 149  
 chocolate spread 135  
 choir 301  
 choke v 47  
 chop 119, 237  
 chopping board 68  
 chorizo 143  
 choux pastry 140  
 christening 26  
 Christmas 27  
 chrysanthemum 110  
 chuck 78  
 church 298, 300  
 chutney 134  
 cider 145  
 cider vinegar 135  
 cigar 112  
 cigarettes 112  
 cinema 255, 299  
 cinema hall 255  
 cinnamon 133  
 circle 165, 254
- circular saw 78  
 circuit training 251  
 circumference 164  
 cistern 61  
 citrus fruit 126  
 city 299  
 clam 121  
 clamp 78, 166  
 clamp stand 166  
 clapper board 179  
 clarinet 257  
 clasp 36  
 classical music 255, 259  
 classroom 162  
 claw 291  
 clay 85, 275  
 clean v 77  
 clean clothes 76  
 cleaned 121  
 cleaner 188  
 cleaning equipment 77  
 cleaning fluid 51  
 cleanser 41  
 clear honey 134  
 cleat 240  
 cleaver 68  
 clementine 126  
 client 38, 175, 180  
 cliff 285  
 climber 87  
 climbing frame 263  
 clinic 48  
 clipboard 173  
 clitoris 20  
 clock 62  
 clock radio 70  
 closed 260, 321  
 clothes line 76  
 clothes peg 76  
 clothing 205  
 cloud 287  
 cloudy 286  
 clove 125  
 clover 297  
 cloves 133  
 club 273  
 club sandwich 155  
 clubhouse 232  
 clutch 200, 204  
 coach 196  
 coal 288  
 coast 285  
 coaster 150  
 coastguard 217  
 coat 32  
 coat hanger 70  
 cockatoo 293  
 cockerel 185  
 cockle 121  
 cockpit 210  
 cockroach 295  
 cocktail 151  
 cocktail shaker 150  
 cocoa powder 148  
 coconut 129  
 cocoon 295  
 cod 120  
 coffee 144, 148, 153, 156, 184

- coffee cup 65  
 coffee machine 148, 150  
 coffee milkshake 149  
 coffee spoon 153  
 coffee table 62  
 cog 206  
 coin 97  
 coin phone 99  
 coin return 99  
 cola 144  
 colander 68  
 cold 44, 286, 321  
 cold tap 72  
 cold-pressed oil 135  
 collage 275  
 collar 32  
 collar bone 17  
 colleague 24  
 collection 98  
 college 168  
 Colombia 315  
 colony 315  
 colouring pencil 163  
 colours 39, 274  
 comb 38  
 comb v 38  
 combat sports 236  
 combine harvester 182  
 comedy 255  
 comet 280  
 comic 112  
 commis chef 152  
 commission 97  
 communications 98  
 commuter 208  
 Comoros 317  
 compact 40  
 compact disc 269  
 company 175  
 compartment 209  
 compass 165, 312, 240  
 complaint 94  
 complexion 41  
 compliments slip 173  
 compost 88  
 compost heap 85  
 computer 172, 176  
 concealer 40  
 conceive v 20  
 conception 52  
 concert 255, 258  
 concertina file 173  
 concourse 209  
 concrete block 187  
 concussion 46  
 condensed milk 136  
 conditioner 38  
 condom 21  
 conductor 256  
 cone 164, 187  
 confectioner 113  
 confectionery 107, 113  
 confident 25  
 confused 25  
 conglomerate 288  
 Congo 317  
 conifer 86  
 connect v 177  
 connection 212  
 conning tower 215  
 console 269  
 constellation 281  
 construction 186  
 consultant 49  
 consultation 45  
 contact lenses 51  
 container 216, 311  
 container port 216  
 container ship 215  
 continent 282, 315  
 contraception 21, 52  
 contraction 52  
 control tower 212  
 controller 269  
 controls 201, 204  
 convector heater 60  
 convenience food 107  
 convertible 199  
 convoyer belt 106  
 cooked meat 118, 143  
 cooking 67  
 coolant reservoir 202  
 cooling rack 69  
 co-pilot 211  
 copper 289  
 copy v 172  
 cor anglais 257  
 coral reef 285  
 cordless phone 99  
 core 127  
 coriander 133  
 cork 134  
 corkscrew 150  
 corn 130, 184  
 corn bread 139  
 corn oil 135  
 cornea 51  
 corner 223  
 corner flag 223  
 cornice 300  
 corset 35  
 Corsica 316  
 Costa Rica 314  
 costume 255  
 cot 74  
 cottage cheese 136  
 cottage garden 84  
 cotton 184, 277  
 cotton balls 41  
 cough 44  
 cough medicine 108  
 counsellor 55  
 count v 165  
 counter 96, 98, 100, 142, 272  
 country 259, 315  
 couple 24  
 courgette 125  
 courier 99  
 courses 153  
 court 226  
 court case 180  
 court date 180  
 court officer 180  
 court official 180  
 courtroom 180  
 courtyard 58, 84  
 couscous 130  
 cousin 22  
 cow 185  
 cow's milk 136  
 crab 121, 295  
 cracked wheat 130  
 cradle 95  
 crafts 275  
 cramp 239  
 cramps 44  
 cranberry 127  
 crane 187, 216, 292  
 crash barrier 195  
 crater 283  
 crayfish 121  
 cream 109, 137, 140, 157  
 cream cheese 136  
 cream pie 141  
 crease 225  
 credit card 96  
 creel 245  
 creeper 87  
 crème caramel 141  
 crème pâtisserie 140  
 crêpe 155  
 crescent moon 280  
 crew 241  
 crew hatch 281  
 cricket 225, 295  
 cricket ball 225  
 cricketer 225  
 crime 94  
 criminal 181  
 criminal record 181  
 crisp 127  
 crispbread 139, 156  
 crisper 67  
 crisps 113, 151  
 Croatia 316  
 crochet 277  
 crochet hook 277  
 crockery 64  
 crockery and cutlery 65  
 crocodile 293  
 crocodile clip 167  
 croissant 156  
 crop 39, 183  
 crops 184  
 cross trainer 250  
 crossbar 207, 222, 235  
 cross-country skiing 247  
 crow 292  
 crown 50  
 crucible 166  
 crushed 132  
 crust 139, 282  
 cry v 25  
 crystal healing 55  
 Cuba 314  
 cube 164  
 cucumber 125  
 cuff 32, 45  
 cufflink 36  
 cultivate v 91  
 cultivator 182  
 cumin 132  
 curb 298  
 cured 118, 159, 143  
 curler 38  
 curling 247  
 curling tongs 38  
 curly 39  
 currant 129  
 current account 96  
 curry 158  
 curry powder 132  
 curtain 63, 254  
 curved 165  
 cushion 62  
 custard 140  
 customer 96, 104, 106, 152  
 customer service department 175  
 customer services 104  
 customs 212  
 customs house 216  
 cut 46  
 cut v 38, 79, 277  
 cuticle 15  
 cutlery 64  
 cuts 119  
 cutting 91  
 cuttlefish 121  
 cycle v 207  
 cycle lane 206  
 cycling 263  
 cylinder 164  
 cylinder head 202  
 cymbals 257  
 Cyprus 316  
 Czech Republic 316  
  
**D**  
 daffodil 111  
 dairy 107  
 dairy farm 183  
 dairy produce 136  
 daisy 110, 297  
 dam 300  
 dance 259  
 dance academy 169  
 dancer 191  
 dandelion 123, 297  
 dandruff 39  
 dark 41, 321  
 darkroom 271  
 darn v 277  
 dartboard 273  
 darts 273  
 dashboard 201  
 date 129, 306  
 daughter 22  
 daughter-in-law 22  
 dawn 305  
 day 305, 306  
 dead ball line 221  
 deadhead v 91  
 deal v 273  
 debit card 96  
 decade 307  
 decay 50  
 December 306  
 deciduous 86  
 decimal 165  
 deck 214  
 deck chair 265  
 decking 85  
 decorating 82  
 decoration 141  
 decorator 82  
 deep end 239  
 deep fried 159  
 deep sea fishing 245  
 deer 291  
 defence 181, 220  
 defendant 181  
 defender 223  
 defending zone 224  
 defrost v 67  
 degree 169  
 delay 209  
 deli 107  
 delicatessen 142  
 delivery 52, 98  
 deltoid 16  
 Democratic Republic of the Congo 317  
 Denmark 316  
 denomination 97  
 denominator 165  
 dental care 108  
 dental floss 50, 72  
 dental hygiene 72  
 dental x-ray 50  
 dentist 50, 189  
 dentist's chair 50  
 dentures 50  
 deodorant 73  
 deodorants 108  
 department 169  
 department store 105  
 departments 49  
 departure lounge 213  
 departures 213  
 depth 165  
 dermatology 49  
 descaled 121  
 desert 285  
 desiccated 129  
 designer 191, 277  
 desk 162, 172  
 desktop 177  
 desktop organizer 172  
 dessert 153  
 desserts 140  
 destination 213  
 detached 58  
 detective 94  
 detergent 77  
 deuce 230  
 develop v 271  
 diabetes 44  
 diagonal 164  
 dial v 99  
 diameter 164  
 diamond 273, 288  
 diaphragm 19, 21  
 diarrhoea 44, 109  
 diary 175  
 dice 272



- dictionary 163  
die v 26  
diesel 199  
diesel train 208  
difficult 321  
dig v 90, 227  
digestive 19  
digital 269  
digital camera 270  
dilation 52  
dill 133  
dimensions 165  
dimple 15  
dining car 209  
dining room 64  
dinner 64, 158  
dinner plate 65  
diopter 51  
diploma 169  
dipstick 202  
direct current 60  
direct debit 96  
directions 260  
director 254  
directory enquiries 99  
dirt bike 205  
dirty washing 76  
disabled parking 195  
discharged 48  
disconnected 99  
discus 234  
discuss v 163  
disembark v 217  
dishwasher 66  
disinfectant solution 51  
disk 176  
dispensary 108  
disposable 109  
disposable camera 270  
disposable nappy 30  
disposable razor 73  
dissertation 169  
distance 310  
distributor 203  
district 315  
dive 239  
dive v 238  
diver 238  
diversion 195  
divide v 165  
divided by 165  
dividends 97  
divider 173, 194  
divorce 26  
Diwali 27  
DJ 179  
Djibouti 317  
do not bend v 98  
dock 214, 216  
dock v 217  
doctor 45, 189  
doctorate 169  
documentary 178  
dog 290  
dog sledding 247  
doll 75  
doll's house 75  
dolphin 290
- dome 300  
domestic flight 212  
Dominica 314  
Dominican Republic 314  
dominoes 273  
donkey 185  
door 196, 198, 209  
door chain 59  
door knob 59  
door knocker 59  
door lock 200  
doorbell 59  
doormat 59  
dormer 58  
dorsal fin 294  
dosage 109  
double 151  
double bass 256  
double bassoon 257  
double bed 71  
double cream 137  
double room 100  
double-decker bus 196  
doubles 230  
dough 138  
Dover sole 120  
down 320  
downhill skiing 247  
download v 177  
dragonfly 295  
drain 61, 72, 299  
drain cock 61  
drainage 91  
draining board 67  
draughts 272  
draw 223  
draw v 162  
drawer 66, 70, 172  
drawer unit 172  
drawing 275  
drawing pin 173  
dress 31, 34  
dressage 243  
dressed 159  
dressed chicken 119  
dressing 47, 158  
dressing gown 31, 32  
dressing table 71  
dribble v 223  
dried flowers 111  
dried fruit 156  
drill 50  
drill v 79  
drill bit 78  
drill bits 80  
drinking cup 75  
drinking fountain 262  
drinks 107, 144, 156  
drip 53  
drive v 195, 233  
driver 196  
driver's cab 208  
driver's seat 196  
driveshaft 202  
drop anchor v 217  
dropper 109, 167  
drops 109
- dropshot 230  
drown v 239  
drum 258  
drum kit 258  
drummer 258  
dry 39, 41, 130, 145, 286, 321  
dry v 76  
dry cleaners 115  
dry dock 217  
dual carriageway 195  
duck 119, 185  
duck egg 137  
duckling 185  
duffel coat 31  
dugout 229  
dumb bell 251  
dumper truck 187  
dungarees 30  
dunk v 227  
duodenum 18  
dusk 305  
dust v 77  
dust pan 77  
duster 77  
dustsheet 83  
duty-free shop 213  
duvet 71  
DVD disk 269  
DVD player 268  
dyed 39  
dynamo 207
- E**  
eagle 292  
ear 14  
early 305, 320  
earring 36  
Earth 280, 282  
earthenware dish 69  
earthing 60  
earthquake 283  
easel 174, 274  
east 312  
East Timor 319  
Easter 27  
easy 321  
easy cook 130  
eat v 64  
eat-in 154  
eating 75  
eau de toilette 41  
eaves 58  
éclair 140  
eclipse 280  
economics 169  
economy class 211  
Ecuador 315  
eczema 44  
Edam 142  
edge 246  
editor 191  
eel 294  
egg 20  
egg cup 65, 137  
egg white 137  
eggs 137  
Egypt 317
- eight 308  
eight hundred 308  
eighteen 308  
eighteenth 309  
eighth 309  
eightieth 309  
eighty 308  
ejaculatory duct 21  
El Salvador 314  
elbow 13  
electric blanket 71  
electric drill 78  
electric guitar 258  
electric razor 73  
electric shock 46  
electric train 208  
electrical goods 105, 107  
electrician 188  
electricity 60  
electricity meter 60  
elephant 291  
eleven 308  
eleventh 309  
elm 296  
email 98, 177  
email account 177  
email address 177  
embarrassed 25  
embossed paper 83  
embroidery 277  
embryo 52  
emerald 288  
emergency 46  
emergency exit 210  
emergency lever 209  
emergency phone 195  
emergency room 48  
emergency services 94  
emigrate v 26  
emotions 25  
employee 24  
employer 24  
empty 321  
emulsion 83  
enamel 50  
encore 255  
encyclopedia 163  
end 321  
end zone 220  
endive 123  
endline 226  
endocrine 19  
endocrinology 49  
engaged/busy 99  
engaged couple 24  
engine 202, 204, 208, 210  
engine room 214  
engineering 169  
English breakfast 157  
english mustard 135  
engraving 275  
enlarge v 172  
enlargement 271  
enquiries 168  
ENT 49  
entrance 59  
entrance fee 260  
envelope 98, 173
- environment 280  
epidural 52  
epiglottis 19  
epilepsy 44  
episiotomy 52  
equals 165  
equation 165  
equator 283  
equipment 233, 238  
equipment 165  
Equatorial Guinea 317  
equity 97  
Eritrea 317  
erupt v 283  
escalator 104  
espresso 148  
essay 163  
essential oils 55  
estate 199  
estate agent 189  
estate agent's 115  
Estonia 316  
estuary 285  
Ethiopia 317  
eucalyptus 296  
Europe 316  
evening 305  
evening dress 34  
evening menu 152  
events 243, 247  
evergreen 86  
evidence 181  
examination 163  
excess baggage 212  
exchange rate 97  
excited 25  
excuse me 322  
executive 174  
exercise bike 250  
exercises 251  
exfoliate v 41  
exhaust pipe 203, 204  
exhibit v 261  
exhibition 261  
exit 210  
exit ramp 194  
exosphere 286  
expectant 52  
experiment 166  
expiry date 109  
exposure 271  
extend v 251  
extension 58  
extension lead 78  
exterior 198  
extra time 223  
extraction 50  
extractor 66  
eye 14, 51, 244, 276  
eye shadow 40  
eye test 51  
eyebrow 14, 51  
eyebrow brush 40  
eyebrow pencil 40  
eyecup 269  
eyelash 14, 51  
eyelet 37  
eyelid 51

- eyeliner 40  
 eyepiece 167  
**F**  
 fabric 277  
 fabric conditioner 76  
 face 14  
 face cream 73  
 face mask 225  
 face pack 41  
 face powder 40  
 face-off circle 224  
 facial 41  
 factory 299  
 faint v 25, 44  
 fair 41  
 fairground 262  
 fairway 232  
 falcon 292  
 Falkland Islands 315  
 fall 237  
 fall in love v 26  
 Fallopian tube 20  
 family 22  
 famous ruin 261  
 fan 60, 202  
 fan belt 203  
 fans 258  
 far 320  
 fare 197, 209  
 farm 182, 183, 184  
 farmer 182, 189  
 farmhouse 182  
 farmland 182  
 farmyard 182  
 fashion 277  
 fast 321  
 fast food 154  
 fast forward 269  
 fastening 37  
 fat 119, 321  
 fat free 137  
 father 22  
 father-in-law 23  
 fault 230  
 fax 98, 172  
 fax machine 172  
 feather 293  
 feature film 269  
 February 306  
 feed v 183  
 feijoa 128  
 female 12, 20  
 feminine hygiene 108  
 femur 17  
 fence 85, 182, 243  
 fencing 249  
 feng shui 55  
 fennel 122, 133  
 fennel seeds 133  
 fenugreek 132  
 fern 86  
 ferry 215, 216  
 ferry terminal 216  
 fertilization 20  
 fertilize v 91  
 fertilizer 91  
 festivals 27  
 fever 44  
 fiancé 24  
 fiancée 24  
 fibre 127  
 fibula 17  
 field 182, 222, 228, 234  
 field v 225, 229  
 field hockey 224  
 fifteen 308  
 fifteenth 309  
 fifth 309  
 fiftieth 309  
 fifty 308  
 fifty five thousand, five hundred 309  
 fifty thousand 309  
 fig 129  
 fighter plane 211  
 figure skating 247  
 Fiji 319  
 filament 60  
 file 81, 172, 177  
 filing cabinet 172  
 fill v 82  
 filler 83  
 fillet 119, 121  
 filleted 121  
 filling 50, 140, 155  
 film 260, 271  
 film set 179  
 film spool 271  
 filo pastry 140  
 filter 270  
 filter coffee 148  
 filter paper 167  
 fin 210  
 finance 97  
 financial advisor 97  
 fingerprint 94  
 finial 300  
 finishing line 234  
 Finland 316  
 fire 95  
 fire alarm 95  
 fire brigade 95  
 fire engine 95  
 fire escape 95  
 fire extinguisher 95  
 fire fighters 95  
 fire station 95  
 firelighter 266  
 fireman 189  
 fireplace 63  
 firm 124  
 first 309  
 first aid 47  
 first aid box 47  
 first floor 104  
 first night 254  
 fish 107, 120, 294  
 fish and chips 155  
 fish farm 183  
 fish slice 68  
 fisherman 189  
 fishhook 244  
 fishing 244, 245  
 fishing boat 217  
 fishing permit 245  
 fishing port 217  
 fishing rod 244  
 fishmonger 188  
 fishmonger's 114, 120  
 fist 15, 237  
 fitness 250  
 five 308  
 five hundred 308  
 flag 221, 232  
 flageolet beans 131  
 flakes 132  
 flamingo 292  
 flan 142  
 flan dish 69  
 flare 240  
 flash 270  
 flash gun 270  
 flask 166  
 flat 59, 256  
 flatbread 139  
 flat race 243  
 flat wood bit 80  
 flavoured oil 134  
 flax 184  
 fleece 74  
 flesh 124, 127, 129  
 flex v 251  
 flight attendant 210  
 flight number 213  
 flint 288  
 flipchart 174  
 flip-flop 37  
 flipper 239, 290  
 float 238, 244  
 float ball 61  
 flock 183  
 flood 287  
 floor 58, 62, 71  
 floor exercises 235  
 floor plan 261  
 florentine 141  
 floret 122  
 florist 110, 188  
 floss v 50  
 floors 138  
 flower 297  
 flowerbed 85, 90  
 flowering plant 297  
 flowering shrub 87  
 flowers 110  
 flu 44  
 flute 139, 257  
 fly 244, 295  
 fly v 211  
 fly fishing 245  
 flyover 194  
 flysheet 266  
 foal 185  
 focus v 271  
 focusing knob 167  
 foetus 52  
 fog 287  
 foil 249  
 folder 177  
 foliage 110  
 folk music 259  
 follicle 20  
 font 177  
 food 118, 130, 149  
 food hall 105  
 food processor 66  
 foot 12, 15, 310  
 football 220, 222  
 football field 220  
 football player 220  
 football strip 31, 222  
 footballer 222  
 footboard 71  
 footpath 262  
 footstrap 241  
 for 320  
 forceps 53, 167  
 forearm 12  
 forecourt 199  
 forehand 231  
 forehead 14  
 foreign currency 97  
 foreskin 21  
 forest 285  
 fork 65, 88, 153, 207  
 fork-lift truck 186, 216  
 formal garden 84  
 formal gardens 262  
 fortieth 309  
 fortnight 307  
 forty 308  
 forty minutes 304  
 forward 222  
 foul 222, 226  
 foul ball 228  
 foul line 229  
 foundation 40  
 fountain 85  
 four 308  
 four hundred 308  
 four-door 200  
 fourteen 308  
 fourteenth 309  
 fourth 309  
 four-wheel drive 199  
 fox 290  
 foxglove 297  
 fraction 165  
 fracture 46  
 fragile 98  
 fragranced 130  
 frame 51, 62, 206, 267  
 frame counter 270  
 France 316  
 freckle 15  
 free 321  
 free kick 222  
 free range 118  
 free weights 250  
 freesia 110  
 free-throw line 226  
 freeze 287  
 freezer v 67  
 freezer 67  
 freight train 208  
 freighter 215  
 French bean 122  
 french fries 154  
 French Guiana 315  
 French horn 257  
 french mustard 135  
 french pleat 39  
 French toast 157  
 frequency 179  
 fresh 121, 127, 130  
 fresh cheese 136  
 fresh fruit 157  
 freshwater fishing 245  
 fret 258  
 fretsaw 81  
 Friday 306  
 fridge-freezer 67  
 fried 159  
 fried chicken 155  
 fried egg 157  
 friend 24  
 frieze 301  
 frog 294  
 from 320  
 front crawl 239  
 front door 58  
 front wheel 196  
 frontal 16  
 frost 287  
 froth 148  
 frown 25  
 frozen 121, 124  
 frozen food 107  
 frozen yoghurt 137  
 fruit 107, 126, 128  
 fruit bread 139  
 fruit cake 140  
 fruit farm 183  
 fruit gum 113  
 fruit juice 127, 156  
 fruit tart 140  
 fruit yoghurt 157  
 fry v 67  
 frying pan 69  
 fuel gauge 201  
 fuel tank 204  
 full 64, 266, 321  
 full board 101  
 full moon 280  
 fumble 220  
 funeral 26  
 funnel 166, 214  
 furniture shop 115  
 furrow 183  
 fuse 60  
 fuse box 60, 203  
 fuselage 210  
**G**  
 gable 300  
 Gabon 317  
 Galapagos Islands 315  
 galaxy 280  
 gale 286  
 galley 214  
 gallon 311  
 gallop 243  
 galvanised 79  
 Gambia 317  
 game 119, 230, 273  
 game show 178  
 games 272  
 gangway 214



- garage 58, 199  
 garden 84  
 garden centre 115  
 garden features 84  
 garden pea 122  
 garden plants 86  
 garden styles 84  
 garden tools 88  
 gardener 188  
 gardening 90  
 gardening gloves 89  
 gardens 261  
 garland 111  
 garlic 125, 132  
 garlic press 68  
 garnet 288  
 garter 35  
 gas burner 61  
 gasket 61  
 gate 85, 182, 247  
 gate number 213  
 gauze 47, 167  
 gear lever 207  
 gearbox 202, 204  
 gears 206  
 gearstick 201  
 gel 38, 109  
 gems 288  
 generation 23  
 generator 60  
 genitals 12  
 geography 162  
 geometry 165  
 Georgia 318  
 gerbera 110  
 Germany 316  
 get a job v 26  
 get married v 26  
 get up v 71  
 geyser 285  
 Ghana 317  
 giant slalom 247  
 gifts shop 114  
 gill 294  
 gin 145  
 gin and tonic 151  
 ginger 39, 125, 133  
 giraffe 291  
 girder 186  
 girl 23  
 girlfriend 24  
 girth 242  
 glacier 284  
 gladiolus 110  
 gland 19  
 glass 69, 152  
 glass bottle 166  
 glass rod 167  
 glasses 51, 150  
 glassware 64  
 glaze v 139  
 glider 211, 248  
 gliding 248  
 gloss 83, 271  
 glove 224, 233, 236, 246  
 gloves 36  
 glue 275  
 glue gun 78
- gneiss 288  
 go to bed v 71  
 go to sleep v 71  
 goal 221, 223, 224  
 goal area 223  
 goal line 220, 223, 224  
 goalkeeper 222, 224  
 goalpost 220, 222  
 goat 185  
 goat's cheese 142  
 goat's milk 136  
 goggles 238, 247  
 going out 75  
 gold 235, 289  
 goldfish 294  
 golf 232  
 golf bag 233  
 golf ball 233  
 golf clubs 233  
 golf course 232  
 golf shoe 233  
 golf trolley 233  
 golfer 232  
 gong 257  
 good 321  
 good afternoon 322  
 good evening 322  
 good morning 322  
 good night 322  
 goodbye 322  
 goose 119, 293  
 goose egg 137  
 gooseberry 127  
 gorge 284  
 gorilla 291  
 gothic 301  
 grade 163  
 graduate 169  
 graduate v 26  
 graduation ceremony 169  
 graft v 91  
 grains 130  
 gram 310  
 granary bread 139  
 grandchildren 23  
 granddaughter 22  
 grandfather 22  
 grandmother 22  
 grandparents 23  
 grandson 22  
 granite 288  
 grape juice 144  
 grapefruit 126  
 grapeseed oil 134  
 graphite 289  
 grass 86, 262  
 grass bag 88  
 grasshopper 295  
 grassland 285  
 grate v 67  
 grated cheese 136  
 grater 68  
 gratin dish 69  
 gravel 88  
 gravity 280  
 graze 46  
 greasy 39
- Greece 316  
 green 129, 232, 274  
 green olive 143  
 green peas 131  
 green salad 158  
 green tea 149  
 greengrocer 188  
 greengrocer's 114  
 greenhouse 85  
 Greenland 314  
 Grenada 314  
 grey 39, 274  
 grill v 67  
 grill pan 69  
 grilled 159  
 groceries 106  
 grocer's 114  
 groin 12  
 groom 243  
 ground 132  
 ground coffee 144  
 ground cover 87  
 ground floor 104  
 ground sheet 267  
 groundnut oil 135  
 group therapy 55  
 grout 83  
 guard 236  
 Guatemala 314  
 guava 128  
 guest 64, 100  
 guidebook 260  
 guided tour 260  
 guilty 181  
 Guinea 317  
 Guinea-Bissau 317  
 guitarist 258  
 gull 292  
 gum 50  
 gun 94  
 gutter 58, 299  
 guy rope 266  
 Guyana 315  
 gym 101, 250  
 gym machine 250  
 gymnast 235  
 gymnastics 235  
 gynaecologist 52  
 gynaecology 49  
 gypsophila 110
- H**  
 haberdashery 105  
 hacksaw 81  
 haddock 120  
 haemorrhage 46  
 hail 286  
 hair 14, 38  
 hair dye 40  
 hairband 38  
 hairdresser 38, 188  
 hairdresser's 115  
 hairdryer 38  
 hairpin 38  
 hairspray 38  
 hairtie 39  
 Haiti 314  
 half an hour 304
- half board 101  
 half time 223  
 half-litre 311  
 hall of residence 168  
 halibut fillets 120  
 Halloween 27  
 hallway 59  
 halter 243  
 halter neck 35  
 ham 119, 143, 156  
 hammer 80  
 hammer v 79  
 hammock 266  
 hamper 263  
 hamster 290  
 hamstring 16  
 hand 13, 15  
 hand drill 81  
 hand fork 89  
 hand luggage 211, 213  
 hand rail 59  
 hand saw 89  
 hand towel 73  
 handbag 37  
 handbrake 203  
 handcuffs 94  
 handicap 233  
 handkerchief 36  
 handle 36, 88, 106, 187, 200, 230  
 handlebar 207  
 handles 37  
 handrail 196  
 handsaw 80  
 handset 99  
 hang v 82  
 hang-glider 248  
 hang-gliding 248  
 hanging basket 84  
 hanging file 173  
 happy 25  
 harbour 217  
 harbour master 217  
 hard 129, 321  
 hard cheese 136  
 hard drive 176  
 hard hat 186  
 hard shoulder 194  
 hardboard 79  
 hardware 176  
 hardware shop 114  
 hardwood 79  
 haricot beans 131  
 harness race 243  
 harp 256  
 harvest v 91, 183  
 hat 36  
 hatchback 199  
 have a baby v 26  
 Hawaii 314  
 hay 184  
 hayfever 44  
 hazard 195  
 hazard lights 201  
 hazelnut 129  
 hazelnut oil 134  
 head 12, 19, 81, 230  
 head v 222
- head injury 46  
 head office 175  
 head teacher 163  
 headache 44  
 headboard 70  
 headlight 198, 205  
 headphones 268  
 headrest 200  
 headsail 240  
 health 44  
 health centre 168  
 health food shop 115  
 heart 18, 119, 122, 273  
 heart attack 44  
 heater 60  
 heater controls 201  
 heather 297  
 heating element 61  
 heavy 321  
 heavy metal 259  
 hedge 85, 90, 182  
 hedgehog 290  
 heel 13, 15, 37  
 height 165  
 height bar 45  
 helicopter 211  
 hello 322  
 helmet 95, 204, 206, 220, 224, 228  
 hem 34  
 hematite 289  
 hen's egg 137  
 herb 55, 86  
 herb garden 84  
 herbaceous border 85  
 herbal remedies 108  
 herbal tea 149  
 herbalism 55  
 herbicide 183  
 herbs 133, 134  
 herbs and spices 132  
 herd 183  
 hexagon 164  
 hi-fi system 268  
 high 321  
 high chair 75  
 high dive 239  
 high heel shoe 37  
 high jump 235  
 high speed train 208  
 highlights 39  
 hiking 263  
 hill 284  
 Himalayas 313  
 hip 12  
 hippopotamus 291  
 historic building 261  
 history 162  
 history of art 169  
 hit v 224  
 hob 67  
 hockey 224  
 hockey stick 224  
 hoe 88  
 hold 215, 237  
 holdall 37  
 hole 232  
 hole in one 233

- hole punch 173  
 holiday 212  
 holiday brochure 212  
 holey 296  
 home 58  
 home delivery 154  
 home entertainment 268  
 home furnishings 105  
 home plate 228  
 homeopathy 55  
 homework 163  
 homogenised 137  
 Honduras 314  
 honeycomb 135  
 honeymoon 26  
 honeysuckle 297  
 hood 31, 75  
 hoof 242, 291  
 hook 187, 276  
 hoop 226, 277  
 horizontal bar 235  
 hormone 20  
 horn 201, 204, 291  
 horror film 255  
 horse 185, 235, 242  
 horse race 243  
 horse riding 242, 263  
 horseradish 125  
 horseshoe 242  
 hose 95  
 hose reel 89  
 hosepipe 89  
 hospital 48  
 host 64  
 hostess 64  
 hot 124, 286, 321  
 hot chocolate 144, 156  
 hot dog 155  
 hot drinks 144  
 hot tap 72  
 hot-air balloon 211  
 hotel 100, 264  
 hot-water bottle 70  
 hour 304  
 hour hand 304  
 house 58  
 household products 107  
 hovercraft 215  
 hub 206  
 hubcap 202  
 hull 214, 240  
 humerus 17  
 humid 286  
 hummingbird 292  
 hump 291  
 hundred 308  
 hundred and ten 308  
 hundred thousand 308  
 hundredth 309  
 Hungary 316  
 hungry 64  
 hurdles 235  
 hurricane 287  
 husband 22  
 husk 130  
 hydrant 95  
 hydrofoil 215  
 hydrotherapy 55
- hypnotherapy 55  
 hypoallergenic 41  
 hypotenuse 164
- I**  
 ice 120, 287  
 ice and lemon 151  
 ice bucket 150  
 ice climbing 247  
 ice cream 149  
 ice cube 151  
 ice hockey 224  
 ice hockey player 224  
 ice hockey rink 224  
 ice maker 67  
 ice-cream 137  
 iced coffee 148  
 iced tea 149  
 ice-skate 224  
 ice-skating 247  
 icicle 287  
 icing 141  
 icon 177  
 identity badge 189  
 identity tag 53  
 igneous 288  
 ignition 200  
 iguana 293  
 illness 44  
 immigration 212  
 impotent 20  
 in 320  
 in brine 143  
 in front of 320  
 in oil 143  
 in sauce 159  
 in syrup 159  
 inbox 177  
 inch 310  
 incisor 50  
 incubator 53  
 index finger 15  
 India 318  
 Indian Ocean 312  
 indicator 198, 204  
 indigo 274  
 Indonesia 319  
 induce labour v 53  
 industrial estate 299  
 infection 44  
 infertile 20  
 infield 228  
 inflatable dinghy 215  
 information 261  
 information screen 213  
 in-goal area 221  
 inhaler 44, 109  
 injection 48  
 injury 46  
 ink 275  
 ink pad 173  
 inlet 61  
 inner core 282  
 inner tube 207  
 inning 228  
 innocent 181  
 inoculation 45  
 insect repellent 108, 267
- inside 320  
 inside lane 194  
 insomnia 71  
 inspector 94  
 install v 177  
 instant camera 270  
 instep 15  
 instructions 109  
 instruments 256, 258  
 insulating tape 81  
 insulation 61  
 insulin 109  
 insurance 203  
 intensive care unit 48  
 inter-city train 209  
 intercom 59  
 intercostal 16  
 intercourse 20  
 interest rate 96  
 interior 200  
 internal systems 60  
 international flight 212  
 internet 177  
 intersection 298  
 interval 254  
 interviewer 179  
 into 320  
 in-tray 172  
 invertebrates 295  
 investigation 94  
 investment 97  
 ionosphere 286  
 Iran 318  
 Iraq 318  
 Ireland 316  
 iris 51, 110  
 iron 76, 109, 233, 289  
 iron v 76  
 ironing board 76  
 island 282  
 Israel 318  
 Italy 316  
 itinerary 260  
 IUD 21  
 Ivory Coast 317
- J**  
 jack 203, 273  
 jacket 32, 34  
 jade 288  
 jam 134, 156  
 Jamaica 314  
 January 306  
 Japan 318  
 jar 134, 311  
 javelin 234  
 jaw 14, 17  
 jazz 259  
 jeans 31  
 jelly bean 113  
 jellyfish 295  
 Jerusalem artichoke 125  
 jet 288  
 jet skiing 241  
 jetty 217  
 jeweller 188  
 jeweller's 114  
 jewellery 36
- jewellery box 36  
 jewellery making 275  
 jigsaw 78  
 jigsaw puzzle 273  
 jodhpurs 242  
 jog on the spot 251  
 jogging 251, 263  
 joint 17, 119  
 joker 273  
 Jordan 318  
 journal 168  
 journalist 190  
 judge 180  
 judo 236  
 jug 65  
 juices and milkshakes 149  
 juicy 127  
 July 306  
 jump 237, 243  
 jump v 227  
 jump ball 226  
 junction 194  
 June 306  
 Jupiter 280  
 jury 180  
 jury box 180
- K**  
 kale 123  
 Kaliningrad 316  
 kangaroo 291  
 karate 236  
 kayak 241  
 Kazakhstan 318  
 kebab 155, 158  
 keel 214  
 keep net 244  
 kendo 236  
 Kenya 317  
 kernel 122, 129, 130  
 ketchup 135  
 kettle 66  
 kettledrum 257  
 key 59, 80, 176, 207  
 keyboard 172, 176, 258  
 keypad 97, 99  
 kick 237, 239  
 kick v 221, 223  
 kickboxing 236  
 kickstand 207  
 kid 185  
 kidney 18, 119  
 kilogram 310  
 kilometre 310  
 king 272, 273  
 king prawn 121  
 kippers 157  
 kitchen 66, 152  
 kitchen knife 68  
 kitchenware 68, 105  
 kitten 290  
 kiwifruit 128  
 knead v 138  
 knee 12  
 knee pad 205  
 knee support 227  
 kneecap 17  
 knee-length 34
- knickers 35  
 knife 65, 80  
 knife sharpener 68, 118  
 knight 272  
 knitting 277  
 knitting needle 277  
 knock out 237  
 knuckle 15  
 koala 291  
 kohlrabi 123  
 koi carp 294  
 kumquat 126  
 kung fu 236  
 Kuwait 318  
 Kyrgyzstan 318
- L**  
 label 172  
 labels 89  
 labia 20  
 laboratory 166  
 lace 35, 37  
 lace bobbin 277  
 lace making 277  
 lace-up 37  
 lacrosse 249  
 lactose 137  
 ladder 95, 186  
 ladle 68  
 ladybird 295  
 lake 285  
 lamb 118, 185  
 lamp 62, 207, 217  
 land 282  
 land v 211  
 landing 59  
 landing gear 210  
 landing net 244  
 landlord 58  
 landscape 271, 284  
 landscape v 91  
 lane 234, 238  
 languages 162  
 Laos 318  
 lapel 32  
 laptop 175  
 larch 296  
 large 321  
 large intestine 18  
 larynx 19  
 last week 307  
 lat 16  
 late 305  
 later 304  
 latitude 283  
 Latvia 316  
 laugh v 25  
 launch 281  
 launch pad 281  
 launderette 115  
 laundry 76  
 laundry basket 76  
 laundry service 101  
 lava 283  
 law 169, 180  
 lawn 85, 90  
 lawn rake 88



- lawnmower 88, 90  
 lawyer 180, 190  
 lawyer's office 180  
 laxative 109  
 lay the table v 64  
 lead singer 258  
 leaded 199  
 leaf 122, 296  
 leaflets 96  
 league 223  
 lean meat 118  
 learn v 163  
 leather shoe 37  
 leather shoes 32  
 leathers 205  
 Lebanon 318  
 lecture theatre 169  
 lecturer 169  
 leek 125  
 left 260  
 left field 228  
 left-hand drive 201  
 leg 12, 119  
 leg pad 225  
 leg press 251  
 legal advice 180  
 legal department 175  
 leggings 31  
 leisure 258, 254, 264  
 lemon 126  
 lemon curd 134  
 lemon grass 133  
 lemon sole 120  
 lemonade 144  
 length 165, 310  
 lens 270  
 lens (eye) 51  
 lens (glasses) 51  
 lens cap 270  
 lens case 51  
 Lesotho 317  
 lesson 163  
 let! 231  
 letter 98  
 letterbox 58, 99  
 letterhead 173  
 lettuce 123  
 lever 61, 150  
 lever arch file 173  
 Liberia 317  
 librarian 168, 190  
 library 168, 299  
 library card 168  
 Libya 317  
 licence plate 198  
 liquorice 113  
 lid 61, 66  
 Liechtenstein 316  
 life events 26  
 life jacket 240  
 life raft 240  
 lifeboat 214  
 lifebuoy 240  
 lifeguard 239, 265  
 lifeguard tower 265  
 lift 59, 100, 104  
 ligament 17  
 light 178, 321  
 light a fire v 266  
 light aircraft 211  
 light bulb 60  
 lighter 112  
 lighthouse 217  
 lighting 105  
 lightmeter 270  
 lightning 287  
 lights 94  
 lights switch 201  
 lily 110  
 lime 126, 296  
 limestone 288  
 limousine 199  
 line 244  
 line judge 220  
 line of play 233  
 linen 105, 277  
 linen basket 76  
 lines 165  
 linesman 223, 230  
 lingerie 35, 105  
 lining 32  
 lining paper 83  
 link 36  
 lintel 186  
 lion 291  
 lip 14  
 lip brush 40  
 lip gloss 40  
 lip liner 40  
 lipstick 40  
 liqueur 145  
 liquid 77  
 liquid dispenser 311  
 liquid measure 311  
 literature 162, 169  
 Lithuania 316  
 litre 311  
 little finger 15  
 little toe 15  
 live 60, 178  
 live rail 209  
 liver 18, 118  
 livestock 183, 185  
 living room 62  
 lizard 293  
 load v 76  
 loaf 139  
 loan 96, 168  
 loans desk 168  
 lob 230  
 lobby 100, 255  
 lobster 121, 295  
 lock 59, 207  
 lockers 239  
 log on v 177  
 loganberry 127  
 logo 31  
 loin 121  
 lollipop 113  
 long 32  
 long jump 235  
 long sight 51  
 long wave 179  
 long-grain 130  
 long-handled shears 88  
 longitude 283  
 loofah 73  
 loom 277  
 loose leaf tea 144  
 lorry 194  
 lorry driver 190  
 lose v 273  
 loser 273  
 lottery tickets 112  
 love 230  
 low 321  
 luge 247  
 luggage 100, 198, 213  
 luggage department 104  
 luggage hold 196  
 luggage rack 209  
 lumbar vertebrae 17  
 lunar module 281  
 lunch 64  
 lunch menu 152  
 lung 18  
 lunge 251  
 lupins 297  
 lure 244  
 Luxembourg 316  
 lychee 128  
 lymphatic 19  
 lyrics 259  
**M**  
 macadamia 129  
 mace 132  
 Macedonia 316  
 machine gun 189  
 machinery 187  
 mackerel 120  
 macramé 277  
 Madagascar 317  
 magazine 112  
 magazines 107  
 magma 283  
 magnesium 109  
 magnet 167  
 maid service 101  
 mailbag 98, 190  
 main course 153  
 mains supply 60  
 mainsail 240  
 make a will v 26  
 make friends v 26  
 make bread 138  
 malachite 288  
 Malawi 317  
 Malaysia 318  
 Maldives 318  
 male 12, 21  
 Mali 317  
 mallet 78, 275  
 malt vinegar 135  
 Malta 316  
 malted drink 144  
 mammals 290  
 man 23  
 manager 24, 174  
 managing director 175  
 manchego 142  
 mane 242, 291  
 mango 128  
 mangosteen 128  
 manhole 299  
 manicure 41  
 mantelpiece 63  
 mantle 282  
 manual 200  
 map 195, 261  
 maple 296  
 maple syrup 134  
 maracas 257  
 marathon 234  
 marble 288  
 March 306  
 margarine 137  
 marina 217  
 marinated 143, 159  
 marine fishing 245  
 marjoram 133  
 mark v 227  
 market 115  
 marketing department 175  
 marmalade 134, 156  
 marrow 124  
 Mars 280  
 marshmallow 113  
 martial arts 237  
 martini 151  
 marzipan 141  
 mascara 40  
 mashed 159  
 masher 68  
 mask 189, 228, 236, 239, 249  
 masking tape 83  
 masonry bit 80  
 massage 54  
 mast 240  
 masters 169  
 mat 54, 83, 235, 271  
 match 230  
 matches 112  
 material 276  
 materials 79, 187  
 maternity 49  
 maternity ward 48  
 maths 162, 164  
 mattress 70, 74  
 Mauritiana 317  
 Mauritius 317  
 May 306  
 maybe 322  
 mayonnaise 135  
 MDF 79  
 meadow 285  
 meal 64  
 measles 44  
 measure 150, 151  
 measure v 310  
 measurements 165  
 measuring jug 69, 311  
 measuring spoon 109  
 meat 119  
 meat and poultry 106  
 meat tenderizer 68  
 meatballs 158  
 meathook 118  
 mechanic 188, 203  
 mechanical digger 187  
 mechanics 202  
 medals 235  
 media 178  
 medical examination 45  
 medication 109  
 medicine 109, 169  
 medicine cabinet 72  
 meditation 54  
 Mediterranean Sea 313  
 medium wave 179  
 meeting 174  
 meeting room 174  
 melody 259  
 melon 127  
 memory 176  
 men's clothing 32  
 men's wear 105  
 menstruation 20  
 menu 148, 153, 154  
 menubar 177  
 mercury 289  
 Mercury 280  
 meringue 140  
 mesosphere 286  
 messages 100  
 metacarpal 17  
 metal 79  
 metal bit 80  
 metals 289  
 metamorphic 288  
 metatarsal 17  
 meteor 280  
 metre 310  
 Mexico 314  
 mica 289  
 microlight 211  
 microphone 179, 258  
 microscope 167  
 microwave oven 66  
 midday 305  
 middle finger 15  
 middle lane 194  
 midnight 305  
 midwife 53  
 migraine 44  
 mile 310  
 milk 136, 156  
 milk v 183  
 milk carton 136  
 milk chocolate 113  
 milkshake 137  
 millennium 307  
 millet 130  
 milligram 310  
 millilitre 311  
 millimetre 310  
 mince 119  
 mineral 144  
 minerals 289  
 mini bar 101  
 mini disk recorder 268  
 minibus 197  
 mint 113, 133  
 mint tea 149  
 minus 165  
 minute 304  
 minute hand 304

- minutes 174  
 mirror 40, 63, 71, 167  
 miscarriage 52  
 Miss 23  
 missile 211  
 mist 287  
 mitre block 81  
 mitt 228  
 mittens 30  
 mix v 67, 138  
 mixed salad 158  
 mixing bowl 66, 69  
 mixing desk 179  
 moat 300  
 mobile 74  
 mobile phone 99  
 model 169, 190  
 model making 275  
 modelling tool 275  
 modem 176  
 moisturizer 41  
 molar 50  
 Moldova 316  
 mole 14  
 Monaco 316  
 Monday 306  
 money 97  
 Mongolia 318  
 monitor 172, 176  
 monitor 53  
 monkey 291  
 monkfish 120  
 monopoly 272  
 monorail 208  
 monsoon 287  
 month 306  
 monthly 307  
 monument 261  
 Moon 280  
 moonstone 288  
 moor v 217  
 mooring 217  
 mop 77  
 morning 305  
 Morocco 317  
 mortar 68, 167, 187  
 mortgage 96  
 Moses basket 74  
 mosque 300  
 mosquito 295  
 mosquito net 267  
 moth 295  
 mother 22  
 mother-in-law 23  
 motor 88  
 motor racing 249  
 motorbike 204  
 motorbike racing 249  
 motorcross 249  
 motorway 194  
 moulding 63  
 mountain 284  
 mountain bike 206  
 mountain range 282  
 mouse 176, 290  
 mousse 141  
 mouth 14  
 mouth guard 237  
 mouthwash 72  
 move 273  
 mow v 90  
 Mozambique 317  
 mozzarella 142  
 MP3 player 268  
 Mr 23  
 Mrs 23  
 mudguard 205  
 muffin 140  
 muffin tray 69  
 mug 65  
 mulch v 91  
 multiply v 165  
 multivitamin tablets 109  
 mumps 44  
 mung beans 131  
 muscles 16  
 museum 261  
 mushroom 125  
 music 162  
 music school 169  
 musical 255  
 musical score 255  
 musical styles 259  
 musician 191  
 mussel 121, 295  
 mustard 155  
 mustard seed 131  
 Myanmar 318  
**N**  
 naan bread 139  
 nail 15, 80  
 nail clippers 41  
 nail file 41  
 nail scissors 41  
 nail varnish 41  
 nail varnish remover 41  
 Namibia 317  
 nape 13  
 napkin 65, 152  
 napkin ring 65  
 nappy 75  
 nappy rash cream 74  
 narrow 321  
 nation 315  
 national park 261  
 natural 256  
 natural fibre 31  
 naturopathy 55  
 nausea 44  
 navel 12  
 navigate v 240  
 near 320  
 nebula 280  
 neck 12, 258  
 neck brace 46  
 necklace 36  
 neckline 34  
 nectarine 126  
 needle 109, 276  
 needle plate 276  
 needle-nose pliers 80  
 needlepoint 277  
 negative 271  
 negative electrode 167  
 negligée 35  
 neighbour 24  
 neoclassical 301  
 Nepal 318  
 nephew 23  
 Neptune 280  
 nerve 19, 50  
 nervous 19, 25  
 net 217, 222, 226, 227, 231  
 net v 245  
 net curtain 63  
 Netherlands 316  
 nettle 297  
 network 176  
 neurology 49  
 neutral 60  
 neutral zone 224  
 new 321  
 new moon 280  
 new potato 124  
 New Year 27  
 New Zealand 319  
 newborn baby 53  
 news 178  
 newsagent 112  
 newspaper 112  
 newsreader 179, 191  
 next week 306  
 nib 163  
 Nicaragua 314  
 nickel 289  
 niece 23  
 Niger 317  
 Nigeria 317  
 night 305  
 nightdress 35  
 nightie 31  
 nightwear 31  
 nine 308  
 nine hundred 308  
 nineteen 308  
 nineteen hundred 307  
 nineteen hundred and one 307  
 nineteen ten 307  
 nineteenth 309  
 ninetieth 309  
 ninety 308  
 ninth 309  
 nipple 12  
 no 322  
 no entry 195  
 no right turn 195  
 no stopping 195  
 non-smoking section 152  
 non-stick 69  
 noodles 158  
 normal 39  
 north 312  
 North and Central America 314  
 North Korea 318  
 North pole 283  
 North Sea 312  
 northern hemisphere 283  
 Norway 316  
 nose 14, 210  
 nose clip 238  
 noseband 242  
 nosebleed 44  
 nosewheel 210  
 nostril 14  
 notation 256  
 note 97, 256  
 note pad 173  
 notebook 163, 172  
 notes 175, 191  
 notice board 173  
 nougat 113  
 November 306  
 now 304  
 nozzle 89  
 number 226  
 numbers 308  
 numerator 165  
 nurse 45, 48, 52, 189  
 nursery 74  
 nursing 53  
 nursing bra 53  
 nut 80  
 nutmeg 132  
 nuts 151  
 nuts and dried fruit 129  
 nylon 277  
**O**  
 oak 296  
 oar 241  
 oats 130  
 objective lens 167  
 oboe 257  
 obsidian 288  
 obstetrician 52  
 occupations 188, 190  
 occupied 321  
 ocean 282  
 ocean liner 215  
 octagon 164  
 October 306  
 octopus 121, 295  
 odometer 201  
 oesophagus 19  
 off licence 115  
 offal 118  
 offers 106  
 office 24, 172, 174  
 office block 298  
 office equipment 172  
 office supplies 173  
 off-piste 247  
 off-side 223  
 oil 142, 199  
 oil paints 274  
 oil tank 204  
 oil tanker 215  
 oils 134  
 oily 41  
 ointment 47, 109  
 okra 122  
 old 321  
 olive oil 134  
 olives 151  
 Oman 318  
 omelette 158  
 on time 305  
 on top of 320  
 oncology 49  
 one 308  
 one billion 309  
 one million 309  
 one thousand 309  
 one-way 194  
 one-way system 298  
 onion 124  
 on-line 177  
 onto 320  
 onyx 289  
 opal 288  
 open 260, 321  
 open sandwich 155  
 open-top 260  
 opera 255  
 operating theatre 48  
 operation 48  
 operator 99  
 ophthalmology 49  
 opponent 236  
 opposite 320  
 optic 150  
 optic nerve 51  
 optician 51, 189  
 orange 126, 274  
 orange juice 148  
 orangeade 144  
 orbit 280  
 orchestra 254, 256  
 orchestra pit 254  
 orchid 111  
 order v 153  
 oregano 133  
 organic 91, 118, 122  
 organic waste 61  
 origami 275  
 ornamental 87  
 orthopaedy 49  
 osteopathy 54  
 ostrich 292  
 otter 290  
 ounce 310  
 out 225, 228, 320  
 out of bounds 226  
 out of focus 271  
 outdoor motor 215  
 outbuilding 182  
 outdoor activities 262  
 outer core 282  
 outfield 229  
 outlet 61  
 outpatient 48  
 outside 320  
 outside lane 194  
 out-tray 172  
 oval 164  
 ovary 20  
 oven 66  
 oven glove 69  
 ovenproof 69  
 over 320  
 over par 233  
 overalls 82  
 overdraft 96  
 overexposed 271  
 overflow pipe 61  
 overhead locker 210  
 overhead projector 163  
 overtake v 195



- overture 256  
 ovulation 20, 52  
 owl 292  
 oyster 121  
 ozone layer 286
- P**  
 Pacific Ocean 312  
 pack 311  
 pack of cards 273  
 packet 311  
 packet of cigarettes 112  
 pad 224  
 paddle 241  
 paddling pool 263  
 paddock 242  
 pads 53, 220  
 paediatrics 49  
 painkiller 109  
 painkillers 47  
 paint 83  
 paint v 83  
 paint tin 83  
 paint tray 83  
 painter 191  
 painting 62, 261, 274  
 paints 274  
 pak-choi 123  
 Pakistan 318  
 palate 19  
 palette 274  
 pallet 186  
 palm 15, 86, 296  
 palm hearts 122  
 palmtop 175  
 pan 310  
 pan fried 159  
 Panama 314  
 pancakes 157  
 pancreas 18  
 panda 291  
 panty liner 108  
 papaya 128  
 paper clip 173  
 paper guide 172  
 paper napkin 154  
 paper tray 172  
 papier-mâché 275  
 paprika 132  
 Papua New Guinea 319  
 par 233  
 parachute 248  
 parachuting 248  
 paragliding 248  
 Paraguay 315  
 parallel 165  
 parallel bars 235  
 parallelogram 164  
 paramedic 94  
 parcel 99  
 parents 23  
 park 262  
 park v 195  
 parking meter 195  
 parmesan 142  
 parole 181  
 parrot 293  
 parsley 133
- parsnip 125  
 partner 23  
 pass 226  
 pass v 220, 223  
 passenger 216  
 passenger port 216  
 passion fruit 128  
 Passover 27  
 passport 213  
 passport control 213  
 pasta 158  
 pastels 274  
 pasteurized 137  
 pasting brush 82  
 pasting table 82  
 pastry 140, 149  
 pastry brush 69  
 pasture 182  
 patch 207  
 patchwork 277  
 pâté 142, 156  
 path 58, 85  
 pathology 49  
 patient 45  
 patio garden 85  
 pattern 276  
 pause 269  
 pavement 298  
 pavement café 148  
 paving 85  
 pawn 272  
 pay v 153  
 pay in v 96  
 pay per view channel 269  
 paying-in slips 96  
 payment 96  
 payroll 175  
 peach 126, 128  
 peacock 293  
 peanut 129  
 peanut butter 135  
 peanuts 151  
 pear 127  
 peas 131  
 pecan 129  
 pectoral 16  
 pectoral fin 294  
 pedal 61, 206  
 pedal v 207  
 pedestrian crossing 195  
 pedestrian zone 299  
 pedicure 41  
 pediment 301  
 peel v 67  
 peeled prawns 120  
 peeler 68  
 pelican 292  
 pelvis 17  
 pen 163, 185  
 penalty 222  
 penalty area 223  
 pencil 163, 275  
 pencil case 163  
 pencil sharpener 163  
 pendant 36  
 penfriend 24  
 penguin 292  
 peninsula 282
- penis 21  
 pentagon 164  
 peony 111  
 people 12, 16  
 people carrier 199  
 pepper 64, 124, 152  
 peppercorn 132  
 pepperoni 142  
 percentage 165  
 percussion 257  
 perennial 86  
 perfume 41  
 perfumery 105  
 pergola 84  
 periodical 168  
 perm 39  
 perpendicular 165  
 persimmon 128  
 personal best 234  
 personal CD player 269  
 personal organizer 173, 175  
 personal trainer 250  
 personnel department 175  
 Peru 315  
 pesticide 89, 183  
 pestle 68, 167  
 pet food 107  
 pet shop 115  
 petal 297  
 petri dish 166  
 petrol 199  
 petrol pump 199  
 petrol station 199  
 petrol tank 203  
 pharmacist 108, 189  
 pharynx 19  
 pheasant 119, 293  
 phillips screwdriver 81  
 philosophy 169  
 Philippines 319  
 photo album 271  
 photo finish 234  
 photo frame 271  
 photofit 181  
 photographer 191  
 photograph 271  
 photograph v 271  
 photography 270  
 physical education 162  
 physics 162, 169  
 physiotherapy 49  
 piano 256  
 piccolo 257  
 pick v 91  
 pick and mix 113  
 pickaxe 187  
 pickled 159  
 pickup 258  
 picnic 263  
 picnic bench 266  
 pie 158  
 pie tin 69  
 piece 272  
 pier 217  
 pies 143  
 pig 185  
 pig farm 183  
 pigeon 292
- pigeonhole 100  
 piglet 185  
 pigsty 185  
 pigtailed 39  
 Pilates 251  
 pill 21, 109  
 pillar 300  
 pillion 204  
 pillow 70  
 pillowcase 71  
 pilot 190, 211  
 pin 60, 237, 249, 276  
 pin number 96  
 pincushion 276  
 pine 296  
 pine nut 129  
 pineapple 128  
 pineapple juice 149  
 pink 274  
 pint 311  
 pinto beans 131  
 pip 128  
 pipe 112, 202  
 pipe cutter 81  
 pipette 167  
 piping bag 69  
 pistachio 129  
 pitch 225, 256, 266  
 pitch v 229  
 pitch a tent v 266  
 pitcher 151, 229  
 pitcher's mound 228  
 pitches available 266  
 pith 126  
 pitta bread 139  
 pizza 154  
 pizza parlour 154  
 place mat 64  
 place setting 65  
 placenta 52  
 plain 285  
 plain chocolate 113  
 plain flour 139  
 plait 39  
 plane 81  
 plane v 79  
 planet 280, 282  
 plant v 183  
 plant pot 89  
 plants 86, 296  
 plaque 50  
 plaster 47, 83  
 plaster v 82  
 plastic bag 122  
 plastic pants 30  
 plastic surgery 49  
 plate 65, 283  
 plateau 284  
 platform 208  
 platform number 208  
 platform shoe 37  
 platinum 289  
 play 254, 269  
 play v 229, 273  
 player 221, 231, 273  
 playground 263  
 playhouse 75  
 playing 75
- playpen 75  
 plea 180  
 please 322  
 Plimsoll line 214  
 plough v 183  
 plug 60, 72  
 plum 126  
 plumb line 82  
 plumber 188  
 plumbing 61  
 plunger 81  
 plus 165  
 Pluto 280  
 plywood 79  
 pneumatic drill 187  
 poach v 67  
 poached 159  
 pocket 32  
 pod 122  
 podium 235, 256  
 point 273  
 poisoning 46  
 poker 273  
 Poland 316  
 polar bear 291  
 pole 245, 282  
 pole vault 234  
 police 94  
 police car 94  
 police cell 94  
 police officer 94  
 police station 94  
 policeman 189  
 polish 77  
 polish v 77  
 politics 169  
 polo 243  
 polyester 277  
 pomegranate 128  
 pommel 242  
 pommel horse 235  
 pond 85  
 ponytail 39  
 pool 249  
 pop 259  
 popcorn 255  
 poplar 296  
 popper 30  
 poppy 297  
 poppy seeds 138  
 porch 58  
 porch light 58  
 pore 15  
 pork 118  
 porridge 156  
 port 145, 176, 214, 216  
 porter 100  
 portfolio 97  
 porthole 214  
 portion 64  
 portrait 271  
 Portugal 316  
 positive electrode 167  
 post office 98  
 postage 98  
 postal code 98  
 postal order 98  
 postal worker 98

- postbox 99  
 postcard 112  
 poster 255  
 poster paint 274  
 postgraduate 169  
 postman 98, 190  
 postmark 98  
 pot plant 110  
 pot up v 91  
 potato 124  
 pot-pourri 111  
 potted plant 87  
 potter's wheel 275  
 pottery 275  
 potty 74  
 pouch 291  
 poultry 119  
 poultry farm 183  
 pound 310  
 pour v 67  
 powder 77, 109  
 powder puff 40  
 powdered milk 137  
 power 60  
 power cable 176  
 power cut 60  
 practice swing 233  
 pram 75  
 praying mantis 295  
 pregnancy 52  
 pregnancy test 52  
 pregnant 52  
 premature 52  
 premolar 50  
 pre-recorded 178  
 prescription 45  
 present 27  
 presentation 174  
 presenter 178  
 preservative 83  
 preserved fruit 134  
 press 178  
 presser foot 276  
 press-up 251  
 pressure valve 61  
 price 152, 199  
 price list 154  
 prickly pear 128  
 primer 83  
 primrose 297  
 principality 315  
 print 271  
 print v 172  
 printer 172, 176  
 printing 275  
 prison 181  
 prison guard 181  
 private bathroom 100  
 private jet 211  
 private room 48  
 probe 50  
 problems 271  
 processed grains 130  
 procession 27  
 processor 176  
 producer 254  
 program 176  
 programme 254, 269
- programming 178  
 projector 174  
 promenade 265  
 propagate v 91  
 propeller 211, 214  
 proposal 174  
 prosciutto 143  
 prosecution 180  
 prostate 21  
 protractor 165  
 proud 25  
 prove v 139  
 province 315  
 prow 215  
 prune 129  
 prune v 91  
 psychiatry 49  
 psychotherapy 55  
 public address system 209  
 puck 224  
 pudding rice 130  
 Puerto Rico 314  
 puff pastry 140  
 pull up v 251  
 pulp 127  
 pulse 47  
 pulses 130  
 pumice 288  
 pumice stone 73  
 pump 207  
 pumpkin 125  
 pumpkin seed 131  
 punch 237  
 punch bag 237  
 puncture 203, 207  
 pup 290  
 pupil 51, 162  
 puppy 290  
 purple 274  
 purse 37  
 pushchair 75  
 putt v 233  
 putter 233  
 pyjamas 33  
 pyramid 164
- Q**  
 Qatar 318  
 quadriceps 16  
 quail 119  
 quail egg 137  
 quart 311  
 quarter of an hour 304  
 quarterdeck 214  
 quartz 289  
 quay 216  
 queen 272, 273  
 question 163  
 question v 163  
 quilt 71  
 quilting 277  
 quince 128  
 quinoa 130  
 quiver 249
- R**  
 rabbit 118, 290  
 raccoon 290
- race 234  
 racecourse 243  
 racehorse 243  
 racing bike 205, 206  
 racing dive 239  
 racing driver 249  
 rack 166  
 racquet 230  
 racquet games 231  
 racquetball 231  
 radar 214, 281  
 radiator 60, 202  
 radicchio 123  
 radio 179, 268  
 radio antenna 214  
 radio station 179  
 radiology 49  
 radish 124  
 radius 17, 164  
 rafter 186  
 rafting 241  
 rail 208  
 rail network 209  
 rain 287  
 rainbow 287  
 rainbow trout 120  
 raincoat 31, 32  
 rainforest 285  
 raisin 129  
 rake 88  
 rake v 90  
 rally 230  
 rally driving 249  
 RAM 176  
 Ramadan 26  
 ramekin 69  
 rap 259  
 rapeseed 184  
 rapeseed oil 135  
 rapids 240, 284  
 rash 44  
 rasher 119  
 raspberry 127  
 raspberry jam 134  
 rat 290  
 rattle 74  
 raw 124, 129  
 ray 294  
 razor blade 73  
 razor-shell 121  
 read v 162  
 reading light 210  
 reading list 168  
 reading room 168  
 reamer 80  
 rear light 207  
 rear wheel 197  
 rearview mirror 198  
 receipt 152  
 receive v 177  
 receiver 99  
 reception 100  
 receptionist 100, 190  
 rechargeable drill 78  
 record 234, 269  
 record player 268  
 record shop 115  
 recording studio 179
- rectangle 164  
 rectum 21  
 recycling bin 61  
 red 145, 274  
 red card 223  
 red eye 271  
 red kidney beans 131  
 red lentils 131  
 red meat 118  
 red mullet 120  
 Red Sea 313  
 reduce v 172  
 reel 244  
 reel in v 245  
 refectory 168  
 referee 222, 226  
 referral 49  
 reflector 50, 204, 207  
 reflector strap 205  
 reflexology 54  
 refrigerator 67  
 reggae 259  
 region 315  
 register 100  
 registered post 98  
 regulator 239  
 re-heat v 154  
 reiki 55  
 reins 242  
 relationships 24  
 relatives 23  
 relaxation 55  
 relay race 235  
 release v 245  
 remote control 269  
 Renaissance 301  
 renew v 168  
 rent 58  
 rent v 58  
 repair kit 207  
 report 174  
 reporter 179  
 reproduction 20  
 reproductive 19  
 reproductive organs 20  
 reptiles 293  
 research 169  
 reserve v 168  
 respiratory 19  
 rest 256  
 restaurant 101, 152  
 result 49  
 resurfacing 187  
 resuscitation 47  
 retina 51  
 retire v 26  
 return 231  
 return address 98  
 return date 168  
 rev counter 201  
 reverse v 195  
 reverse charge call 99  
 rewind 269  
 rhinoceros 291  
 rhombus 164  
 rhubarb 127  
 rhythmic gymnastics 235  
 rib 17, 119
- rib cage 17  
 ribbon 27  
 ribbon 39, 111, 141, 235  
 ribs 155  
 rice 130, 158, 184  
 rice pudding 140  
 rider 242  
 riding boot 242  
 riding crop 242  
 riding hat 242  
 rigging 215, 240  
 right 260  
 right field 229  
 right-hand drive 201  
 rim 206  
 rind 119, 127, 136, 142  
 ring 36  
 ring finger 15  
 ring ties 89  
 rings 235  
 rinse v 38, 76  
 riol 129  
 rise v 139  
 river 284  
 road bike 206  
 road markings 194  
 road signs 195  
 roads 194  
 roadworks 187, 195  
 roast 158  
 roast v 67  
 roasted 129  
 robe 38, 169  
 rock climbing 248  
 rock concert 258  
 rock garden 84  
 rocket 123  
 rocks 284, 288  
 Rocky Mountains 312  
 rococo 301  
 rodeo 243  
 roll 139, 311  
 roll v 67  
 roller 83, 187  
 roller blind 63  
 roller coaster 262  
 roller skating 249  
 rollerblading 263  
 rollerskate 249  
 rolling pin 69  
 romance 255  
 Romania 316  
 romper suit 30  
 roof 58, 203  
 roof garden 84  
 roof tile 187  
 roofrack 198  
 rook 272  
 room 58  
 room key 100  
 room number 100  
 room service 101  
 rooms 100  
 root 50, 124, 296  
 roots 39  
 rope 248  
 rose 89, 110, 145  
 rosé 145



- rosemary 133  
 rotor blade 211  
 rotten 127  
 rough 232  
 round 237  
 round neck 33  
 roundabout 195  
 route number 196  
 router 78  
 row 210, 254  
 row v 241  
 rower 241  
 rowing boat 214  
 rowing machine 250  
 rubber 163  
 rubber band 173  
 rubber boots 89  
 rubber ring 265  
 rubber stamp 173  
 rubbish bin 61, 67  
 ruby 288  
 ruck 221  
 rudder 210, 241  
 rug 63  
 rugby 221  
 rugby pitch 221  
 rugby strip 221  
 ruler 163, 165  
 rum 145  
 rum and coke 151  
 rump steak 119  
 run 228  
 run v 228  
 runner bean 122  
 runway 212  
 rush 86  
 rush hour 209  
 Russian Federation 318  
 Rwanda 317  
 rye bread 138
- S**  
 sad 25  
 saddle 206, 242  
 safari park 262  
 safe 228  
 safety 75, 240  
 safety barrier 246  
 safety goggles 81, 167  
 safety pin 47  
 saffron 132  
 sage 133  
 Sahara Desert 313  
 sail 241  
 sailboat 215  
 sailing 240  
 sailor 189  
 salad 149  
 salamander 294  
 salami 142  
 salary 175  
 sales assistant 104  
 sales department 175  
 salmon 120  
 saloon 199  
 salt 64, 152  
 salted 121, 129, 137, 143  
 San Marino 316
- sand 85, 264  
 sand v 82  
 sandal 37  
 sandals 31  
 sandcastle 265  
 sander 78  
 sandpaper 81, 83  
 sandpit 263  
 sandstone 288  
 sandwich 155  
 sandwich counter 143  
 sanitary towel 108  
 São Tomé and Príncipe 317  
 sapphire 288  
 sardine 120  
 Sardinia 316  
 satellite 281  
 satellite dish 269  
 satellite navigation 201  
 satsuma 126  
 Saturday 306  
 Saturn 280  
 sauce 134, 143, 155  
 saucepan 69  
 Saudi Arabia 318  
 sauna 250  
 sausage 155, 157  
 sausages 118  
 sauté v 67  
 save v 177, 223  
 savings 96  
 savings account 97  
 savoury 155  
 saw v 79  
 saxophone 257  
 scaffolding 186  
 scale 121, 256, 294  
 scales 45, 53, 69, 98, 118,  
 166, 212, 293, 310  
 scallop 121  
 scalp 39  
 scalpel 81, 167  
 scan 48, 52  
 scanner 106, 176  
 scarecrow 184  
 scared 25  
 scarf 31, 36  
 schist 288  
 scholarship 169  
 school 162, 299  
 school bag 162  
 school bus 196  
 school uniform 162  
 schoolboy 162  
 schoolgirl 162  
 schools 169  
 science 162, 166  
 science fiction film 255  
 scientist 190  
 scissors 38, 47, 82, 188, 276  
 scoop 68, 149  
 scooter 205  
 score 220, 256, 273  
 score a goal v 223  
 scoreboard 225  
 scorpion 295  
 scotch and water 151  
 scrabble 272
- scrambled eggs 157  
 scrape v 77  
 scraper 82  
 screen 59, 63, 97, 176, 255,  
 269  
 screen wash 199  
 screen wash reservoir 202  
 screw 80  
 screwdriver 80  
 screwdriver bits 80  
 script 254  
 scrollbar 177  
 scrotum 21  
 scrub v 77  
 scrum 221  
 scuba diving 239  
 sculpting 275  
 sculptor 191  
 sea 264, 282  
 sea bass 120  
 sea bream 120  
 sea horse 294  
 sea lion 290  
 sea plane 211  
 seafood 121  
 seal 290  
 sealant 83  
 sealed jar 135  
 seam 34  
 seamstress 191  
 search v 177  
 seasonal 129  
 seasons 306  
 seat 61, 204, 209, 210, 242,  
 254  
 seat back 210  
 seat belt 198, 211  
 seat post 206  
 seating 254  
 secateurs 89  
 second 304, 309  
 second floor 104  
 second hand 304  
 second-hand shop 115  
 section 282  
 security 212  
 security bit 80  
 security guard 189  
 sedative 109  
 sedimentary 288  
 seed 122, 127, 130  
 seed tray 89  
 seeded bread 139  
 seedless 127  
 seedling 91  
 seeds 88, 131  
 seesaw 263  
 segment 126  
 self defence 237  
 self-raising flour 139  
 self-tanning cream 41  
 semidetached 58  
 semi-hard cheese 136  
 seminal vesicle 21  
 semi-skimmed milk 136  
 semi-soft cheese 136  
 semolina 130  
 send v 177
- send off 223  
 Senegal 317  
 sensitive 41  
 sentence 181  
 September 306  
 serve 231  
 serve v 64, 231  
 server 176  
 service included 152  
 service line 230  
 service not included 152  
 service provider 177  
 service vehicle 212  
 serving spoon 68  
 sesame seed 131  
 sesame seed oil 134  
 set 178, 230, 254  
 set v 38  
 set honey 134  
 set sail v 217  
 set square 165  
 set the alarm v 71  
 seven 308  
 seven hundred 308  
 seventeen 308  
 seventeenth 309  
 seventh 309  
 seventieth 309  
 seventy 308  
 sew v 277  
 sewing basket 276  
 sewing machine 276  
 sexually transmitted disease  
 20  
 shade 41  
 shade plant 87  
 shallot 125  
 shallow end 239  
 shampoo 38  
 shapes 164  
 share price 97  
 shares 97  
 shark 294  
 sharp 256  
 sharpening stone 81  
 shaving 73  
 shaving foam 73  
 shears 89  
 shed 84  
 sheep 185  
 sheep farm 183  
 sheep's milk 137  
 sheet 71, 74, 241  
 shelf 67, 106  
 shell 129, 137, 265, 293  
 shelled 129  
 shelves 66  
 sherry 145  
 shiatsu 54  
 shield 88  
 shin 12  
 ship 214  
 ships 215  
 shipyard 217  
 shirt 32  
 shock 47  
 shocked 25  
 shoe department 104
- shoe shop 114  
 shoes 34, 37  
 shoot v 223, 227  
 shop 298  
 shop assistant 188  
 shopping 104  
 shopping bag 106  
 shopping centre 104  
 shops 114  
 short 32, 321  
 short sight 51  
 short wave 179  
 short-grain 130  
 shorts 30, 33  
 shot 151  
 shotput 234  
 shoulder 13  
 shoulder bag 37  
 shoulder blade 17  
 shoulder pad 35  
 shoulder strap 37  
 shout v 25  
 shovel 187  
 shower 72, 286  
 shower block 266  
 shower curtain 72  
 shower door 72  
 shower gel 73  
 shower head 72  
 showjumping 243  
 shuffle v 273  
 shutoff valve 61  
 shutter 58  
 shutter release 270  
 shutter-speed dial 270  
 shuttle bus 197  
 shuttlecock 231  
 shy 25  
 Siberia 313  
 Sicily 316  
 side 164  
 sideline 220  
 side order 153  
 side plate 65  
 side saddle 242  
 side street 299  
 sidedeck 240  
 side-effects 109  
 sideline 226, 230  
 Sierra Leone 317  
 sieve 68, 89  
 sieve v 91  
 sift v 138  
 sigh v 25  
 sightseeing 260  
 sign 104  
 signal 209  
 signature 96, 98  
 silencer 203, 204  
 silk 277  
 silo 183  
 silt 85  
 silver 235, 289  
 simmer v 67  
 Singapore 319  
 singer 191  
 single 151

- single bed 71  
 single cream 137  
 single room 100  
 singles 230  
 sink 38, 61, 66  
 sinus 19  
 siren 94  
 sirloin steak 119  
 sister 22  
 sister-in-law 23  
 site manager's office 266  
 sit-up 251  
 six 308  
 six hundred 308  
 sixteen 308  
 sixteenth 309  
 sixth 309  
 sixtieth 309  
 sixty 308  
 skate 120, 247, 294  
 skate v 224  
 skate wings 120  
 skateboard 249  
 skateboarding 249, 263  
 skein 277  
 skeleton 17  
 sketch 275  
 sketch pad 275  
 skewer 68  
 ski 241, 246  
 ski boot 246  
 ski jump 247  
 ski pole 246  
 ski run 246  
 ski slope 246  
 ski suit 246  
 skier 246  
 skiing 246  
 skimmed milk 136  
 skin 14, 119, 128  
 skin care 108  
 skinned 121  
 skipping 251  
 skirt 30, 34  
 skull 17  
 skydiving 248  
 skyscraper 299, 300  
 slalom 247  
 slate 288  
 sledding 247  
 sledgehammer 187  
 sleeping 74  
 sleeping bag 267  
 sleeping compartment 209  
 sleeping mat 267  
 sleeping pill 109  
 sleepsuit 30  
 sleet 286  
 sleeve 34  
 sleeveless 34  
 slice 119, 139, 140, 230  
 slice v 67  
 sliced bread 138  
 slicer 139  
 slide 167, 263  
 slide v 229  
 sling 46  
 slip 35  
 slip road 194  
 slip-on 37  
 slippers 31  
 slope 284  
 slotted spoon 68  
 Slovakia 316  
 Slovenia 316  
 slow 321  
 slug 295  
 small 321  
 small car 199  
 small intestine 18  
 small of back 13  
 smash 231  
 smile 25  
 smoke 95  
 smoke alarm 95  
 smoked 118, 121, 143, 159  
 smoked fish 143  
 smoking 112  
 smoking section 152  
 snack bar 113, 148  
 snail 295  
 snake 293  
 snare drum 257  
 sneeze 44  
 snooker 249  
 snore v 71  
 snorkel 239  
 snout 293  
 snow 287  
 snowboarding 247  
 snowmobile 247  
 snowsuit 30  
 soak v 130  
 soap 73, 178  
 soap dish 73  
 soccer 222  
 socket 60, 80  
 socket wrench 80  
 socks 33  
 soda bread 139  
 soda water 144  
 sofa 62  
 sofabed 63  
 soft 129, 321  
 soft cheese 136  
 soft drink 154  
 soft drinks 144  
 soft toy 75  
 software 176  
 softwood 79  
 soil 85  
 solar system 280  
 solder 79, 80  
 solder v 79  
 soldering iron 81  
 soldier 189  
 sole 15, 37  
 solids 164  
 Solomon Islands 319  
 soluble 109  
 solvent 83  
 Somalia 317  
 somersault 235  
 son 22  
 sonata 256  
 song 259  
 son-in-law 22  
 sorbet 141  
 sorrel 123  
 sorting unit 61  
 soufflé 158  
 soufflé dish 69  
 sound boom 179  
 sound technician 179  
 soundtrack 255  
 soup 153, 158  
 soup bowl 65  
 soup spoon 65  
 sour 127  
 sour cream 137  
 sourdough bread 139  
 south 312  
 South Africa 317  
 South Korea 318  
 southern hemisphere 283  
 Southern Ocean 313  
 souvenirs 260  
 sow v 90, 183  
 soya beans 131  
 space 280  
 space exploration 281  
 space shuttle 281  
 space station 281  
 space suit 281  
 spade 88, 265, 273  
 Spain 316  
 spanner 80  
 spare tyre 203  
 spark plug 203  
 sparkling 144  
 sparring 237  
 sparrow 292  
 spatula 68, 167  
 speaker 174, 176, 258, 268  
 speaker stand 268  
 spearfishing 245  
 specials 152  
 spectators 233  
 speed boating 241  
 speed limit 195  
 speed skating 247  
 speedboat 214  
 speedometer 201, 204  
 spell v 162  
 sperm 20  
 sphere 164  
 spices 132  
 spicy sausage 142  
 spider 295  
 spike v 90  
 spikes 233  
 spin 230  
 spin v 76  
 spin dryer 76  
 spinach 123  
 spine 17  
 spire 300  
 spirit level 80, 187  
 splashback 66  
 spleen 18  
 splint 47  
 splinter 46  
 split ends 39  
 split peas 131  
 spoke 207  
 sponge 73, 74, 83  
 sponge cake 140  
 sponge fingers 141  
 spool 245  
 spoon 65  
 sport fishing 245  
 sports 105, 220, 236, 248  
 sports car 198  
 sports field 168  
 sports jacket 33  
 sportsman 191  
 spotlight 259  
 sprain 46  
 spray 109  
 spray v 91  
 spray can 311  
 spray gun 89  
 spring 71, 307  
 spring balance 166  
 spring greens 123  
 spring onion 125  
 springboard 235, 238  
 sprinkler 89  
 sprinter 234  
 sprocket 207  
 square 164, 272, 299  
 square foot 310  
 square metre 310  
 squash 231  
 squat 251  
 squid 121, 295  
 squirrel 290  
 Sri Lanka 318  
 St Kitts and Nevis 314  
 St Lucia 314  
 St Vincent and the  
     Grenadines 314  
 stabilisers 207  
 stable 185, 243  
 stadium 223  
 staff 175, 256  
 stage 167, 254  
 stages 23  
 stainless steel 79  
 stair gate 75  
 staircase 59  
 stake 90  
 stake v 91  
 stalk 122, 297  
 stalls 254  
 stamen 297  
 stamp 98  
 stamp collecting 273  
 stamps 112  
 stance 232  
 stand 88, 205, 268  
 stapler 173  
 staples 173  
 star 280  
 star anise 133  
 starfish 295  
 starfruit 128  
 start school v 26  
 starter 153  
 starting block 234, 238  
 starting line 234  
 state 315  
 statement 180  
 stationery 105  
 statuette 260  
 steak 121  
 steam v 67  
 steam train 208  
 steamed 159  
 steeplechase 243  
 steering wheel 201  
 stem 111, 112, 297  
 stencil 83  
 stenographer 181  
 step machine 250  
 stepdaughter 23  
 stepfather 23  
 stepladder 82  
 stepmother 23  
 stepson 23  
 stereo 269  
 sterile 47  
 stern 240  
 stethoscope 45  
 stew 158  
 stick 224, 249  
 sticks 133  
 sticky tape 173  
 still 144  
 sting 46, 295  
 stir v 67  
 stir fry 158  
 stirrer 150  
 stirrup 242  
 stitch 277  
 stitch selector 276  
 stitches 52  
 stock broker 97  
 stock exchange 97  
 stockings 35  
 stocks 97, 110  
 stomach 18  
 stomach ache 44  
 stone 36, 275  
 stoned fruit 126  
 stop 269  
 stop button 197  
 stopper 166  
 stopwatch 234  
 store directory 104  
 stork 292  
 storm 287  
 stout 145  
 stamen 297  
 straight 39, 165  
 straight on 260  
 straighten v 39  
 strap 35  
 strapless 34  
 stratosphere 286  
 straw 144, 154  
 strawberry 127  
 strawberry milkshake 149  
 stream 285  
 street 298  
 street corner 298  
 street light 298  
 street sign 298  
 street stall 154  
 stress 55  
 stretch 251



- stretcher 94  
 strike 228, 237  
 string 230, 258  
 string of pearls 36  
 strings 256  
 strip v 82  
 stroke 44, 233, 239  
 strokes 231  
 strong 321  
 strong flour 139  
 stub 96  
 study 63, 162  
 stuffed 159  
 stuffed olive 143  
 stump 225  
 styles 39, 239, 301  
 submarine 215  
 subsoil 91  
 substitute 223  
 substitution 223  
 subtract v 165  
 suburb 299  
 succulent 87  
 suction hose 77  
 Sudan 317  
 sugarcane 184  
 suit 273  
 sulphur 289  
 sultana 129  
 summer 31, 307  
 summons 180  
 sumo wrestling 237  
 Sun 280  
 sunbathe v 264  
 sunbed 41  
 sunblock 108, 265  
 sunburn 46  
 Sunday 306  
 sunflower 184, 297  
 sunflower oil 134  
 sunflower seed 131  
 sunglasses 51, 265  
 sunhat 30, 265  
 sunny 286  
 sunrise 305  
 sunroof 202  
 sunscreen 108  
 sunset 305  
 sunshine 286  
 suntan lotion 265  
 supermarket 106  
 supersonic jet 211  
 supplement 55  
 supply pipe 61  
 support 187  
 suppository 109  
 surf 241  
 surfboard 241  
 surfcasting 245  
 surfer 241  
 surfing 241  
 surgeon 48  
 surgery 45, 48  
 Suriname 315  
 surprised 25  
 suspect 94, 181  
 suspenders 35  
 suspension 203, 205
- swallow 292  
 swamp 285  
 swan 293  
 Swaziland 317  
 sweater 33  
 sweatpants 33  
 sweatshirt 33  
 sweede 125  
 Sweden 316  
 sweep v 77  
 sweet 124, 127, 155  
 sweet potato 125  
 sweet shop 113  
 sweet spreads 134  
 sweet trolley 152  
 sweetcorn 122  
 sweets 113  
 swim v 238  
 swimmer 238  
 swimming 238  
 swimming pool 101, 238, 250  
 swimsuit 238, 265  
 swing v 232  
 swings 263  
 swiss chard 123  
 switch 60  
 Switzerland 316  
 swivel chair 172  
 sword 236  
 swordfish 120, 294  
 symphony 256  
 synagogue 300  
 synchronized swimming 239  
 synthetic 31  
 Syria 318  
 syringe 109, 167  
 syrup 109  
 system 176
- T**  
 tab 173  
 table 64, 148  
 table tennis 231  
 tablecloth 64  
 tack v 241, 277  
 tackle 245  
 tackle v 220, 223  
 tackle box 244  
 tadpole 294  
 tae-kwon-do 236  
 tag v 229  
 tai chi 236  
 tail 121, 210, 242, 280, 290, 294  
 tail light 204  
 tailbone 17  
 tailgate 198  
 tailor 191  
 tailored 35  
 tailor's 115  
 tailor's chalk 276  
 tailor's dummy 276  
 tailplane 210  
 Tajikistan 318  
 take a bath v 72  
 take a shower v 72  
 take notes v 163
- take off v 211  
 take-away 154  
 talcum powder 73  
 tall 321  
 tambourine 257  
 tampon 108  
 tan 41  
 tandem 206  
 tangerine 126  
 tank 61  
 Tanzania 317  
 tap 61, 66  
 tap water 144  
 tape dispenser 173  
 tape measure 80, 276  
 target 249  
 target shooting 249  
 tarmac 187  
 taro root 124  
 tarragon 133  
 Tasmania 319  
 tattoo 41  
 tax 96  
 taxi driver 190  
 taxi rank 213  
 tea 144, 149, 184  
 tea with lemon 149  
 tea with milk 149  
 teabag 144  
 teacher 54, 162, 191  
 teacup 65  
 team 220, 229  
 teapot 65  
 tear 51  
 teaspoon 65  
 teat 75  
 techniques 79, 159  
 teddy bear 75  
 tee 233  
 teeing ground 232  
 teenager 23  
 tee-off v 233  
 telegram 98  
 telephone 99, 172  
 telephone box 99  
 telescope 281  
 television series 178  
 television studio 178  
 temperature 286  
 temperature gauge 201  
 temple 14, 300  
 ten 308  
 ten thousand 309  
 tenant 58  
 tend v 91  
 tendon 17  
 tennis 230  
 tennis court 230  
 tennis shoes 231  
 tenon saw 81  
 tent 267  
 tent peg 266  
 tent pole 266  
 tenth 309  
 tequila 145  
 terminal 212  
 termite 295  
 terrace café 148
- terraced 58  
 territory 315  
 terry nappy 30  
 test 49  
 test tube 166  
 testicle 21  
 text message 99  
 textbook 163  
 Thailand 318  
 thank you 322  
 Thanksgiving 27  
 the day after tomorrow 307  
 the day before yesterday 307  
 theatre 254, 299  
 theme park 262  
 therapist 55  
 thermals 267  
 thermometer 45, 167  
 thermosphere 286  
 thermostat 61  
 thesis 169  
 thick 321  
 thigh 12, 119  
 thimble 276  
 thin 321  
 third 309  
 thirteen 308  
 thirteenth 309  
 thirtieth 309  
 thirty 308  
 this way up 98  
 this week 307  
 thistle 297  
 thoracic vertebrae 17  
 thread 276  
 thread v 277  
 thread guide 276  
 thread reel 276  
 three 308  
 three hundred 308  
 three-door 200  
 three-point line 226  
 thriller 255  
 throat 19  
 throat lozenge 109  
 throttle 204  
 through 320  
 throw 237  
 throw v 221, 227, 229  
 throw-in 223, 226  
 thruster 281  
 thumb 15  
 thunder 286  
 Thursday 306  
 thyme 133  
 thyroid gland 18  
 tibia 17  
 ticket 209, 213  
 ticket barrier 209  
 ticket inspector 209  
 ticket office 209, 216  
 tie 32  
 tiebreak 230  
 tie-pin 36  
 tiger 291  
 tights 35, 251  
 tile 58, 272  
 tile v 82
- till 106, 150  
 tiller 240  
 timber 187  
 time 234, 304  
 time out 220  
 timer 166  
 times 165, 261  
 timetable 197, 209, 261  
 timing 203  
 tin 289, 311  
 tinned food 107  
 tip 36, 122, 246  
 tissue 108  
 title 168  
 titles 23  
 to 320  
 toad 294  
 toast 157  
 toasted sandwich 149  
 toaster 66  
 tobacco 112, 184  
 today 306  
 toddler 30  
 toe 15  
 toe clip 207  
 toe strap 207  
 toenail 15  
 toffee 113  
 toggle 31  
 Togo 317  
 toilet 72  
 toilet brush 72  
 toilet roll 72  
 toilet seat 72  
 toiletries 41, 107  
 toilets 104, 266  
 toll booth 194  
 tomato 125, 157  
 tomato juice 144, 149  
 tomato sauce 154  
 tomorrow 306  
 toner 41  
 tongs 150, 167  
 tongue 19, 37, 118  
 tonic water 144  
 tonne 310  
 tool rack 78  
 toolbox 177  
 toolbelt 186  
 toolbox 80  
 tools 187  
 tooth 50  
 toothache 50  
 toothbrush 72  
 toothpaste 72  
 top coat 83  
 top dress v 90  
 top tier 141  
 topaz 288  
 topiary 87  
 topping 155  
 topsoil 85  
 torch 267  
 tornado 287  
 tortoise 293  
 touch line 221  
 touchdown 221  
 tour bus 260

- tour guide 260  
 tourer 205  
 touring bike 206  
 tourist 260  
 tourist attraction 260  
 tourist bus 197  
 tourist information 261  
 tourmaline 288  
 tournament 233  
 tow away v 195  
 tow truck 203  
 towards 320  
 towel rail 72  
 towels 73  
 tower 300  
 town 298  
 town hall 299  
 townhouse 58  
 toy 75  
 toy basket 75  
 toys 105  
 track 208, 234  
 tracksuit 31, 32  
 tractor 182  
 traffic 194  
 traffic jam 195  
 traffic light 194  
 traffic policeman 195  
 trailer 266  
 train 35, 208  
 train v 91, 251  
 train station 208  
 trainer 37  
 trainers 31, 251  
 tram 196, 208  
 transfer 223  
 transformer 60  
 transmission 202  
 transplant v 91  
 transport 194  
 trapezium 164  
 trapezoid 164  
 trash 177  
 travel agent 190  
 travel agent's 114  
 travel sickness pills 109  
 traveller's cheque 97  
 tray 152, 154  
 tray-table 210  
 tread 207  
 tread water v 239  
 treadmill 250  
 treble clef 256  
 tree 86, 296  
 trekking 243  
 trellis 84  
 tremor 283  
 triangle 164, 257  
 triceps 16  
 trifle 141  
 trim v 39, 90  
 trimester 52  
 trimmer 88  
 Trinidad and Tobago 314  
 tripod 166, 270, 281  
 trolley 48, 100, 106, 208, 213  
 trolley bus 196
- trombone 257  
 tropic of Cancer 283  
 tropic of Capricorn 283  
 tropical fruit 128  
 tropics 283  
 troposphere 286  
 trot 243  
 trough 183  
 trousers 32, 34  
 trout 120  
 trowel 89, 187  
 truffle 113, 125  
 trug 88  
 trumpet 257  
 truncheon 94  
 trunk 291, 296  
 trunks 238  
 try 221  
 t-shirt 30, 33  
 tub 311  
 tuba 257  
 tube 311  
 Tuesday 306  
 tug boat 215  
 tulip 111  
 tumble 235  
 tumble dryer 76  
 tumbler 65  
 tuna 120  
 tune v 179  
 tune the radio v 269  
 tuning peg 258  
 Tunisia 317  
 turbocharger 203  
 turf v 90  
 Turkey 316  
 turkey 119, 185, 293  
 Turkmenistan 318  
 turneric 132  
 turn 238  
 turn v 79  
 turn the television off v 269  
 turn the television on v 269  
 turnip 124  
 turpentine 83  
 turquoise 289  
 turret 300  
 turtle 293  
 tusk 291  
 tutu 191  
 tweezers 40, 47, 167  
 twelfth 309  
 twelve 308  
 twentieth 309  
 twenty 308  
 twenty minutes 304  
 twenty thousand 309  
 twenty-first 309  
 twenty-one 308  
 twenty-second 309  
 twenty-third 309  
 twenty-two 308  
 twig 296  
 twin room 100  
 twine 89  
 twins 23  
 twist ties 89  
 two 308
- two hundred 308  
 two o'clock 304  
 two thousand 307  
 two thousand and one 307  
 two-door 200  
 types 199, 205  
 types of buses 196  
 types of camera 270  
 types of farm 183  
 types of plants 86  
 types of fishing 245  
 types of train 208  
 tyre 198, 205, 206  
 tyre lever 207  
 tyre pressure 203
- U**  
 Uganda 317  
 ugli 126  
 Ukraine 316  
 ulna 17  
 ultrasound 52  
 ultraviolet rays 286  
 umbilical cord 52  
 umbrella 36, 233  
 umpire 225, 229, 230  
 uncle 22  
 unconscious 47  
 uncooked meat 142  
 under 320  
 under par 233  
 undercoat 83  
 underexposed 271  
 undergraduate 169  
 underground map 209  
 underground train 209  
 underpass 194  
 underwear 32, 35  
 underwired 35  
 uniform 94, 189  
 United Arab Emirates 318  
 United Kingdom 316  
 United States of America 314  
 universe 280  
 university 299  
 unleaded 199  
 unpasteurised 137  
 unpick v 277  
 unsalted 137  
 until 320  
 up 320  
 upper circle 254  
 upset 25  
 Uranus 280  
 ureter 21  
 urethra 20  
 urinary 19  
 urology 49  
 Uruguay 315  
 usher 255  
 uterus 20, 52  
 utility room 76  
 Uzbekistan 318
- V**  
 vacuum cleaner 77, 188  
 vacuum flask 267  
 vagina 20
- valance 71  
 valley 284  
 valve 207  
 vanilla 132  
 Vanuatu 319  
 varnish 79, 83  
 vas deferens 21  
 vase 63, 111  
 Vatican City 316  
 vault 235, 300  
 veal 118  
 vegetable garden 85  
 vegetable oil 135  
 vegetable plot 182  
 vegetables 107, 122, 124  
 veggie burger 155  
 veil 35  
 vein 19  
 venetian blind 63  
 Venezuela 315  
 venison 118  
 vent 283  
 ventouse cup 53  
 Venus 280  
 verdict 181  
 vest 33, 35, 251  
 vet 189  
 vibraphone 257  
 vice 78  
 video game 269  
 video phone 99  
 video recorder 269  
 video tape 269  
 Viet Nam 318  
 viewfinder 271  
 village 299  
 vine 183  
 vinegar 135, 142  
 vineyard 183  
 vintage 199  
 viola 256  
 violin 256  
 virus 44  
 visa 213  
 vision 51  
 visiting hours 48  
 visor 205  
 vitamins 108  
 v-neck 33  
 vocal cords 19  
 vodka 145  
 vodka and orange 151  
 voice message 99  
 volcano 283  
 volley 231  
 volleyball 227  
 voltage 60  
 volume 165, 179, 269, 311  
 vomit v 44
- W**  
 waders 244  
 waffles 157  
 waist 12  
 waistband 35  
 waistcoat 33  
 waiter 148, 152  
 waiting room 45
- waitress 191  
 wake up v 71  
 walk 243  
 walking boot 37  
 walking boots 267  
 walkway 212  
 wall 58, 186, 222  
 wall light 62  
 wallet 37  
 wallpaper 82, 177  
 wallpaper v 82  
 wallpaper brush 82  
 wallpaper paste 82  
 walnut 129  
 walnut oil 134  
 walrus 290  
 ward 48  
 wardrobe 70  
 warehouse 216  
 warm 286  
 warm up v 251  
 warrant 180  
 wash v 38, 77  
 washbasin 72  
 washer 80  
 washer-dryer 76  
 washing machine 76  
 wasp 295  
 waste disposal 61, 266  
 waste disposal unit 61  
 waste pipe 61  
 wastebasket 172  
 watch 36  
 watch television v 269  
 water 144, 238  
 water v 90, 183  
 water bottle 206, 267  
 water chamber 61  
 water chestnut 124  
 water closet 61  
 water garden 84  
 water hazard 232  
 water jet 95  
 water plant 86  
 water polo 239  
 watercolour paints 274  
 watercress 123  
 waterfall 285  
 watering 89  
 watering can 89  
 watermelon 127  
 waterproofs 245, 267  
 waterskier 241  
 waterskiing 241  
 watersports 241  
 wave 241, 264  
 wavelength 179  
 wax 41  
 weak 321  
 weather 286  
 weaving 277  
 website 177  
 wedding 26, 35  
 wedding cake 141  
 wedding dress 35  
 wedding reception 26  
 wedge 233  
 Wednesday 306



weed v 91  
 weed killer 91  
 weeds 86  
 week 306  
 weekend 306  
 weekly 307  
 weigh v 310  
 weight 166, 244  
 weight bar 251  
 weight belt 239  
 weight training 251  
 wellington boots 31  
 west 312  
 western 255  
 Western sahara 317  
 wet 286, 321  
 wet wipe 75, 108  
 wetsuit 239  
 whale 290  
 wheat 130, 184  
 wheel 198, 207  
 wheel nuts 203  
 wheelbarrow 88  
 wheelchair 48  
 wheelchair access 197  
 whiplash 46  
 whipped cream 137  
 whisk 68  
 whisk v 67  
 whiskers 290  
 whisky 145  
 white 39, 145, 272, 274  
 white bread 139  
 white chocolate 113  
 white coffee 148  
 white currant 127  
 white flour 138  
 white meat 118  
 white rice 130  
 white spirit 83  
 whiting 120  
 whole 129, 132  
 whole milk 136  
 wholegrain 131  
 wholegrain mustard 135  
 wholemeal bread 139  
 wholemeal flour 138  
 wicket 225  
 wicket-keeper 225  
 wide 321  
 widescreen television 269  
 width 165  
 wife 22  
 wig 39  
 wild rice 130  
 willow 296  
 win v 273  
 wind 241, 286  
 windbreak 265  
 windcheater 33  
 windlass 214  
 window 58, 96, 98, 177, 186,  
 197, 209, 210  
 windpipe 18  
 windscreen 198  
 windscreen wiper 198  
 windshield 205  
 windsurfer 241

windsurfing 241  
 windy 286  
 wine 145, 151  
 wine glass 65  
 wine list 152  
 wine vinegar 135  
 wing 119, 210, 293  
 wing mirror 198  
 wings 254  
 winner 273  
 winter 31, 307  
 winter sports 247  
 wipe v 77  
 wire 79  
 wire cutter 80  
 wire strippers 81  
 wire wool 81  
 wires 60  
 with 320  
 withdrawal slip 96  
 without 320  
 witness 180  
 wok 69  
 wolf 290  
 woman 23  
 womb 52  
 women's clothing 34  
 women's wear 105  
 wood 79, 233, 275, 285  
 wood glue 78  
 wood shavings 78  
 wooden spoon 68  
 woodpecker 292  
 woodstain 79  
 woodwind 257  
 woodworking 275  
 wool 277  
 work 172  
 work day 306  
 workbench 78  
 workshop 78  
 worktop 66  
 world map 312  
 worm 295  
 worried 25  
 wound 46  
 wrap 155  
 wrapping 111  
 wreath 111  
 wrench 81, 203  
 wrestling 236  
 wrinkle 15  
 wrist 13, 15  
 wristband 230  
 writ 180  
 write v 162

## X

x-ray 48  
 x-ray film 50  
 x-ray machine 212  
 x-ray viewer 45

## Y

yacht 215, 240  
 yam 125  
 yard 310  
 yawn v 25

year 163, 306  
 yeast 138  
 yellow 274  
 yellow card 223  
 Yemen 318  
 yes 322  
 yesterday 306  
 yoga 54  
 yoghurt 137  
 yolk 137, 157  
 you're welcome 322  
 Yugoslavia 316

## Z

Zambia 317  
 zebra 291  
 zero 308  
 zest 126  
 Zimbabwe 317  
 zinc 289  
 zip 277  
 zone 315  
 zones 283  
 zoo 262  
 zoology 169  
 zoom lens 270



## 鸣谢 míngxiè • acknowledgments

DORLING KINDERSLEY would like to thank Tracey Miles and Christine Lacey for design assistance, Georgina Garner for editorial and administrative help, Sonia Gavira, Polly Boyd, and Cathy Meeus for editorial help, and Claire Bowers for compiling the DK picture credits.

The publisher would like to thank the following for their kind permission to reproduce their photographs:  
Abbreviations key:  
t = top, b = bottom, r = right, l = left, c = centre

**Abode:** 62; **Action Plus:** 224bc; **alamy.com:** 154t; A.T. Willett 287bcl; Michael Foyle 184bl; Stock Connection 287bcr; **Allsport/Getty Images:** 238cl; **Alvey and Towers:** 209 acr, 215bcl, 215bcr, 241cr; **Peter Anderson:** 188cbr, 271br. **Anthony Blake Photo Library:** Charlie Stebbings 114cl; John Sims 114tcl; **Andyalte:** 98tl; **apple mac computers:** 268tcr; **Arcaid:** John Edward Linden 301bl; Martine Hamilton Knight, Architects: Chapman Taylor Partners, 213cl; Richard Bryant 301br; **Argos:** 41tcl, 66cbl, 66cl, 66br, 66bcl, 69cl, 70bcl, 71t, 77t, 269tc, 270tl; **Axiom:** Eitan Simanor 105bcr; Ian Cumming 104; Vicki Couchman 148cr; **Beken Of Cows Ltd:** 215bcb; **Bosch:** 76tcr, 76tc, 76tcl; **Camera Press:** 27c, 38tr, 256t, 257cr; Barry J. Holmes 148tr; Jane Hanger 159cr; Mary Germanou 259bc; **Corbis:** 78b; Anna Clopet 247tr; Bettmann 181tl, 181tr; Bo Zauders 156t; Bob Rowan 152bl; Bob Winsett 247cbl; Brian Bailey 247br; Carl and Ann Purcell 162l; Chris Rainer 247ctcl; ChromoSohm Inc. 179tr; Craig Aurness 215bl; David H. Wells 249cbr; Dennis Marsico 274bl; Dimitri Lundt 236bc; Duomo 211t; Gail Mooney 277ctcr; George Lepp 248c; Gunter Marx 248cr; Jack Fields 210b; Jack Hollingsworth 231bl; Jacqui Hurst 277cbr; James L. Ames 247bl, 191ctr, 220bcr; Jan Butchofsky 277cbr; Johnathan Blair 243cr; Jon Feingersh 153tr; Jose F. Poblete 191br; Jose Luis Pelaez.Inc 153tc, 175tl; Karl Weatherly 220bl, 247cr; Kelly Mooney Photography 259tl; Kevin Fleming 249bc; Kevin R. Morris 105tr, 243tl, 243tc; Kim Sayer 249tcr; Lynn Goldsmith 258t; Macduff Everton 231bcl; Mark Gibson 249bl; Mark L. Stephenson 249tcl; Michael Pole 115tr; Michael S. Yamashita 247ctcl; Mike King 247cbl; Neil Rabinowitz 214br; Owen Franken 112t; Pablo Corral 115bc; Paul A. Saunders

169br, 249ctcl; Paul J. Sutton 224c, 224br; Peter Turnley 105tcr; Phil Schermeister 227b, 248tr; R. W. Jones 309; R.V. Jones 175tr; Richard Hutchings 168b; Rick Doyle 241ctr; Robert Holmes 97br, 277ctc; Roger Ressimeyer 169tr; Russ Schleipman 229; Steve Raymer 168cr; The Purcell Team 211ctr; Tim Wright 178; Vince Streato 194t; Wally McNamee 220br, 220bcl, 224bl; Yann Arhus-Bertrand 249tl;

**Demetrio Carrasco / Dorling Kindersley (c) Herge / Les Editions Casterman:** 112ccl; **Dixons:** 270cl, 270cr, 270bl, 270bcl, 270bcr, 270ccr; **Education Photos:** John Walmsley 26tl; **Empics Ltd:** Adam Day 236br; Andy Heading 243c; Steve White 249cbc; **Getty Images:** 48bcl, 100t, 114bcr, 154bl, 287tr; 94tr; **Dennis Gilbert:** 106tc; **Hulsta:** 70t; **Ideal Standard Ltd:** 72r; **The Image Bank/Getty Images:** 58; **Impact Photos:** Eliza Armstrong 115cr; John Arthur 190tl; Philip Achache 246t; **The Interior Archive:** Henry Wilson, Alfie's Market 114bl; Luke White, Architect: David Mikhail, 59tl; Simon Upton, Architect: Phillippe Starck, St Martins Lane Hotel 100bcr, 100br; **Jason Hawkes Aerial Photography:** 216t; **Dan Johnson:** 26cbl, 35r; **Kos Pictures Source:** 215cbl, 240tc, 240tr; David Williams 216b; **Lebrecht Collection:** Kate Mount 169bc; **MP Visual.com:** Mark Swallow 202t; **NASA:** 280cr, 280ccl, 281tl; **P&O Princess Cruises:** 214bl; **P A Photos:** 181br;

**The Photographers' Library:** 186bl, 186bc, 186t; **Plain and Simple Kitchens:** 66t; **Powerstock Photolibrary:** 169tl, 256t, 287tc; **Rail Images:** 208c, 208 cbl, 209br; **Red Consultancy:** Odeon cinemas 257br; **Redferns:** 259br; Nigel Crane 259c; **Rex Features:** 106br, 259tc, 259tr, 259bl, 280b; Charles Ommaney 114tcr; J.F.F Whitehead 243cl; Patrick Barth 101tl; Patrick Frilet 189cbl; Scott Wiseman 287bl; **Royalty Free Images:** Getty Images/Eyewire 154bl; **Science & Society Picture Library:** Science Museum 202b; **Skyscan:** 168t, 182c, 298; Quick UK Ltd 212; **Sony:** 268bc; **Robert Streeter:** 154br; **Neil Sutherland:** 82tr, 83tl, 90t, 118, 188ctr, 196tl, 196tr, 299cl, 299bl; **The Travel Library:** Stuart Black 264t; **Travelex:** 97cl; **Vauxhall:** Technik 198t, 199tl, 199tr, 199cl, 199cr, 199ctcl, 199ctcr, 199tcl, 199tr, 200; **View Pictures:** Dennis Gilbert, Architects: ACDP Consulting, 106t; Dennis Gilbert,

Chris Wilkinson Architects, 209tr; Peter Cook, Architects: Nicholas Crimshaw and partners, 208t; **Betty Walton:** 185br; **Colin Walton:** 2, 4, 7, 9, 10, 28, 42, 56, 92, 95c, 99tl, 99tcl, 102, 116, 120t, 138t, 146, 150t, 160, 170, 191ctcl, 192, 218, 252, 260br, 260l, 261tr, 261c, 261cr, 271cbl, 271cbr, 271ctcl, 278, 287br, 302, 401.

DK PICTURE LIBRARY:  
Akhil Bahkshi; Patrick Baldwin; Geoff Brightling; British Museum; John Bulmer; Andrew Butler; Joe Cornish; Brian Cosgrove; Andy Crawford and Kit Houghton; Philip Dowell; Alistair Duncan; Gables; Bob Gathany; Norman Hollands; Kew Gardens; Peter James Kindersley; Vladimir Kozlik; Sam Lloyd; London Northern Bus Company Ltd; Tracy Morgan; David Murray and Jules Selmes; Musée Vivant du Cheval, France; Museum of Broadcast Communications; Museum of Natural History; NASA; National History Museum; Norfolk Rural Life Museum; Stephen Oliver; RNLi; Royal Ballet School; Guy Ryeart; Science Museum; Neil Setchfield; Ross Simms and the Winchcombe Folk Police Museum; Singapore Symphony Orchestra; Smart Museum of Art; Tony Souter; Erik Svensson and Jeppe Wikstrom; Sam Tree of Keygrove Marketing Ltd; Barrie Watts; Alan Williams; Jerry Young.

Additional Photography by Colin Walton.

Colin Walton would like to thank:  
A&A News, Uckfield; Abbey Music, Tunbridge Wells; Arena Mens Clothing, Tunbridge Wells; Burrells of Tunbridge Wells; Gary at Di Marco's; Jeremy's Home Store, Tunbridge Wells; Noakes of Tunbridge Wells; Ottakar's, Tunbridge Wells; Selby's of Uckfield; Sevenoaks Sound and Vision; Westfield, Royal Victoria Place, Tunbridge Wells.

All other images are Dorling Kindersley copyright. For further information see [www.dkimages.com](http://www.dkimages.com)