

X.R. SANAKULOV, D.P. XODIYEVA, A.R. SANAKULOVA

TEXNOLOGIYA

Umumiy o'rtta ta'lim maktablarining
3-sinfi uchun darslik

*O'zbekiston Respublikasi Xalq ta'limi
vazirligi tasdiqlagan*



«SHARQ» NASHRIYOT-MATBAA
AKSIYADORLIK kompaniyasi
BOSH TAHRIRIYATI
TOSHKENT – 2019

UO'K: 372.831(075)
KBK 74.263
S – 30

T a q r i z c h i l a r :

M.Jumayev – Nizomiy nomidagi TDPU professori;
L.Bekova – Respublika Ta'lim markazi metodisti;
M.Muxiddinova – Toshkent shahar 81-maktab texnologiya fani o'qituvchisi;
N.Komilova – Toshkent shahar 104-maktab texnologiya fani o'qituvchisi.

Shartli belgilar:



– topshiriq



– kasblar haqida ma'lumot



– savol



– uyda bajaring



– eslatma



– mustaqil ish

S–30 **Sanakulov, X.** va boshq.

Texnologiya: 3-sinf uchun darslik / X.R. Sanakulov, D.P. Xodiyeva, A.R. Sanakulova. – T.: «Sharq», 2019. – 80 b.

I. 1,2. Muallifdosh.

UO'K: 372.831(075)
KBK 74.263

**Respublika maqsadli kitob jamg'armasi mablag'lari
hisobidan chop etildi.**

ISBN 978-9943-26-903-3

© X. Sanakulov, D. Xodiyeva, A. Sanakulova, 2016.
© «SHARQ» NMAK Bosh tahririyati, 2016, 2019.

KIRISH

Aziz o'quvchilar!

Siz 2-sinf «Texnologiya» darslarida tabiiy va turli materiallardan parrandalar, hayvonlar, kichik hajmdagi o'yinchoqlar, modellar yasashni, ish qurollaridan xavfsizlik texnikasi qoidalariga rioya qilgan holda foydalanishni o'rgandingiz.

Endi 3-sinfda tabiiy va turli materiallardan bajarilishi jihatdan murakkab, ko'p bosqichli bezakli o'yinchoqlar, maket va modellarni yasashni o'rganasiz.

Amaliy ishni bajarish jarayoniga ijodiy yondashib, yangi loyihalarni tayyorlashda ish qurollaridan to'g'ri va o'rinli foydalanish ko'nikmalarini rivojlantirasiz.

Ushbu darslik sahifalarida berilgan ish namunalarini chiroyli va sifatli bajarishda o'qituvchingiz maslahati, ota-onangiz yordamidan foydalaning.

Aziz o'quvchilar, darslikda berilgan ish namunalarini bajarish bilan, ularning yangi ko'rinishlarini yarating, ixtiro qilishga harakat qiling.

Kelajakda sizni buyuk ishlar kutayotganligini unutmang.

Ushbu darslik sizga yaqin ko'makchi bo'lishiga ishonamiz.

TEXNOLOGIYA DARSIDA BAJARILADIGAN ISH NAMUNALARI

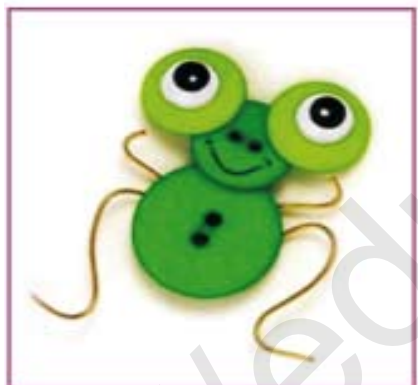
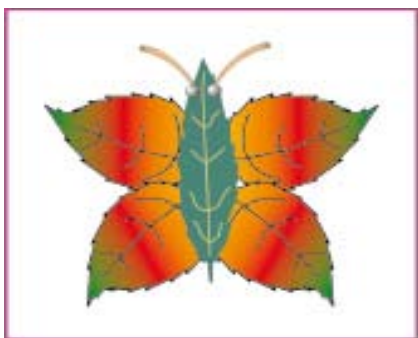

«KUZ» MANZARASINI APPLIKATSIYA USULIDA YASASH

Bizga kerakli ish quollari

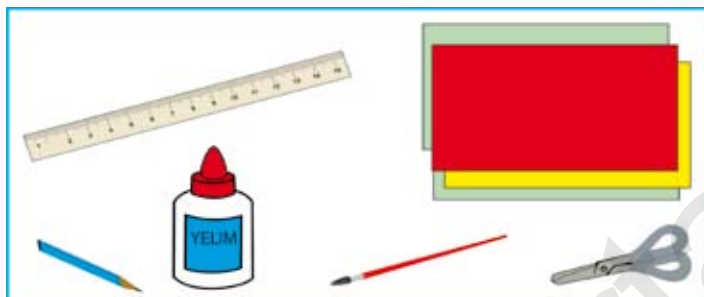

Kuz manzarasiga mos detallarni tayyorlab oling.

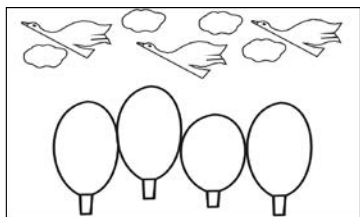

Bog'dagi daraxtlarning joylashish tartibini kuzatib ko'ring. Rangli qog'ozlardan daraxt shakllarini qirqing, ketma-ketlikda joylashtirib yelimgang.

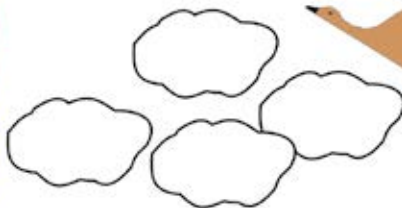

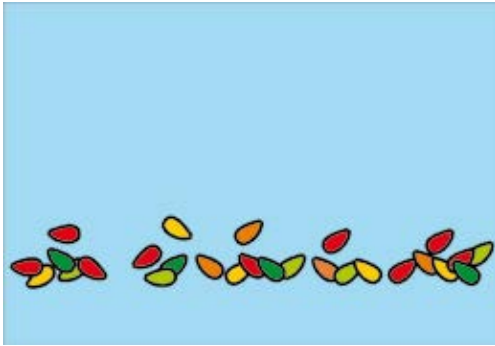

4



5

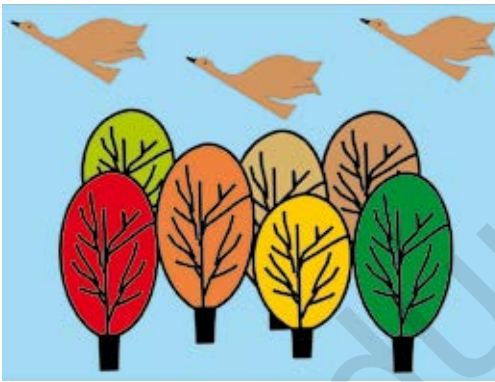

6



7



Har faslni o'z ko'inishida tasvirlashga harakat qiling.



KAPALAK SHAKLINI QURISH-YASASH

! Kapalak shakliga mos barglarni to'plang va tozalab quriting.

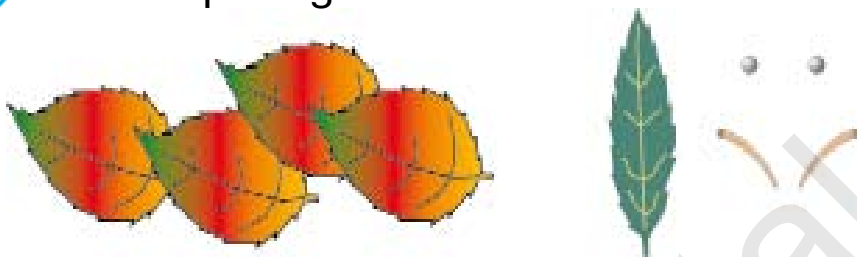

! Kapalak shaklini yasashdan oldin kapalak chizmasini chizib oling.

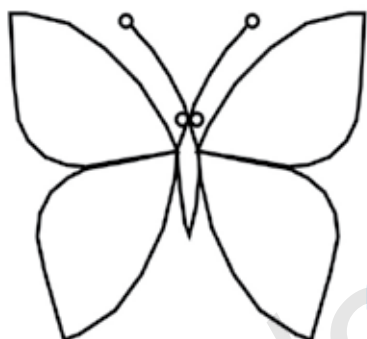

1



2

! Quritilgan barglarni bir-biriga moslab to'g'ri joylashtiring va yelimlang.

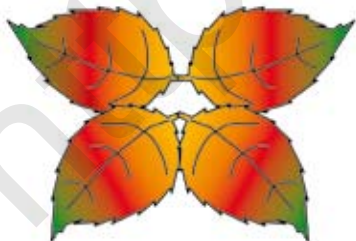

3

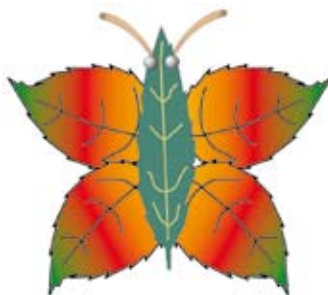

4



Mustaqil ish namunalari.



1



2



Kapalak shaklini qanday materiallardan yasash mumkin?

Siz qanday ko'rinishdagi kapalakni mustaqil yasay olasiz?



3



4



Mustaqil ish namunalari.



HARAKATLI O'YINCHOQLAR YASASH



Kartonga ayiqcha qismlarini chizing va qir-
qib oling.

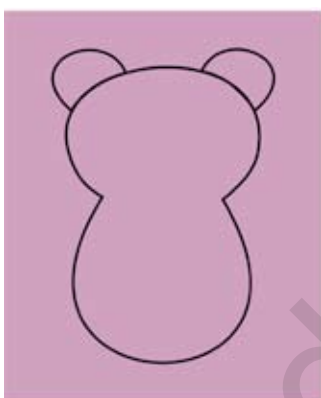

1

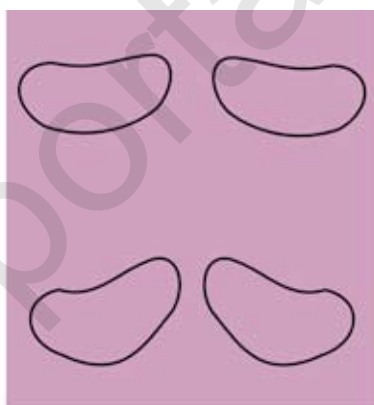

2

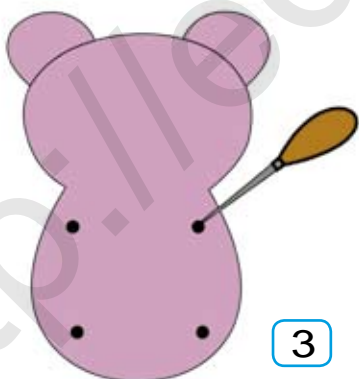

3

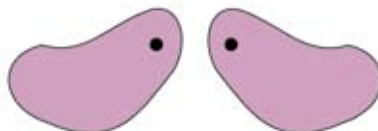
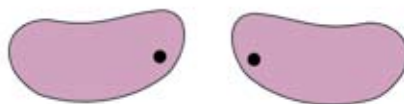

4



Ayiqcha qismlarini biriktirish nuqtalarini belgi-
lang, o'qituvchi nazoratida teshib oling.



Ayiqcha qismlarini quyidagi tartibda biriktiring.

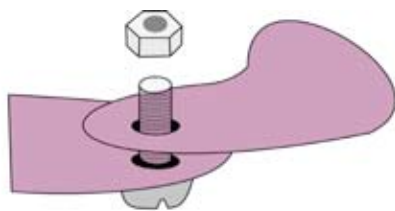

5

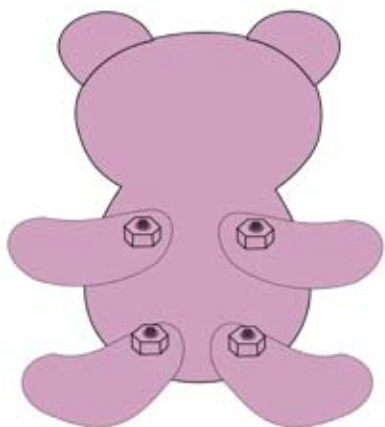

6



7

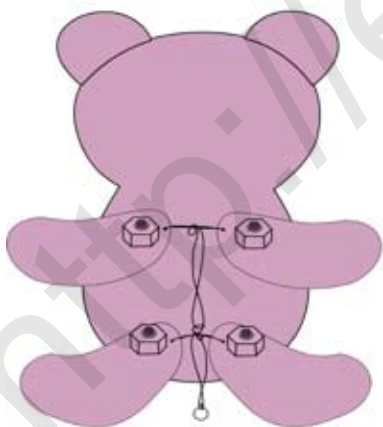

8



9

11



Mustaqil ish namunalari.



Harakatlanuvchi modellarni mustaqil yasashga harakat qiling.



1

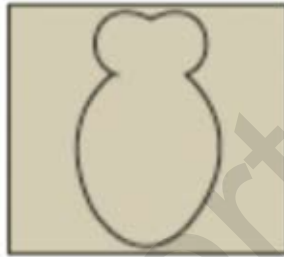

2



3

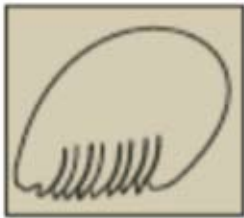

4



5



6



7



8

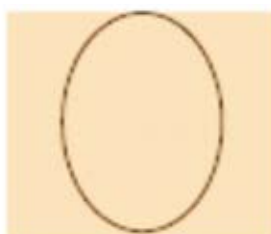

9



10

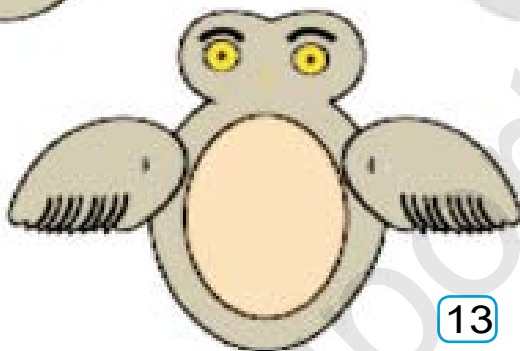
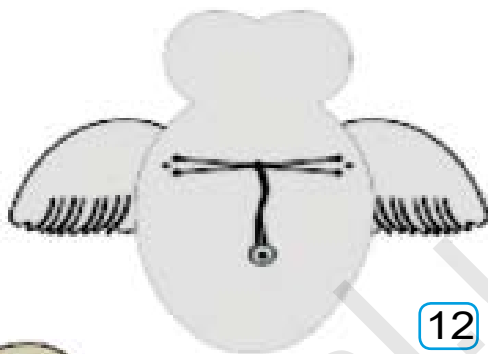
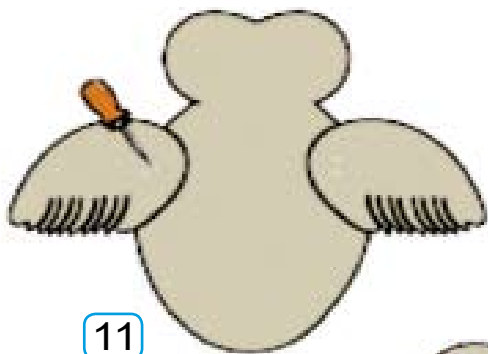

Qush tasvirini applikatsiya usulida mustaqil yasab ko'ring.



SOMONDAN APPLIKATSIYA USULIDA HAYVONLAR, GULLAR, JONIVORLAR SHAKLINI YASASH



Dazmol bilan ishlashda kattalar ko'magidan foydalaning.

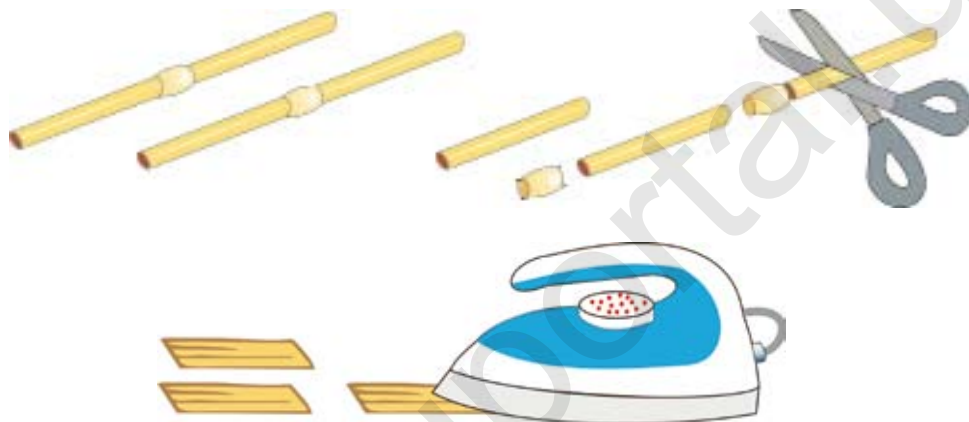

O'qituvchingiz tayyorlab bergan somonlarni qog'ozga yelimlab oling va ketma-ketlikda bajaring.



1



2



3



Mustaqil ish namunalari.



Ish harakatlarini kuzating va yasab ko'ring.



Somondan turli xil kompozitsiya yarating va yaqinlaringizga sovg'a qiling.

1-nazorat ishi

Barglardan jonivorlar shaklini yasash



«ERTAK QAHRAMONLARI»NI APPLIKATSIYA USULIDA YASASH

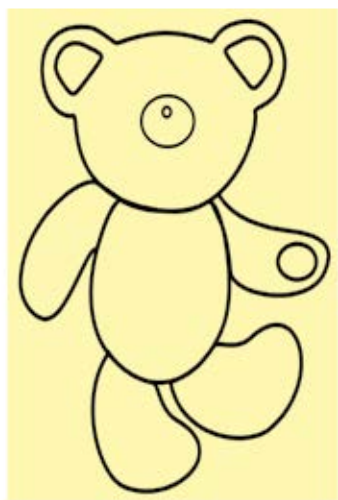

1



2



3



4



5



8



6



7

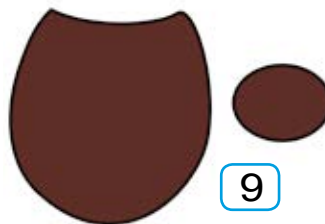

9



Har bir bosqichni ketma-ketlikda, to'g'ri bajar-ing.



10

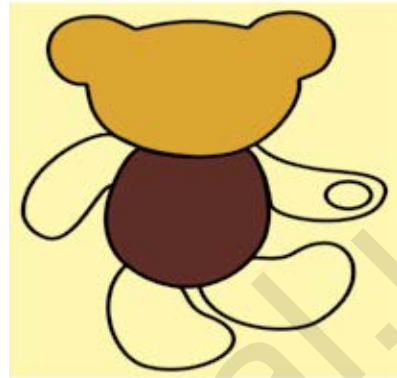

11

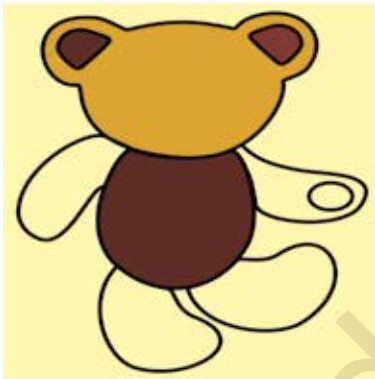

12



13



14



15



O'zingiz sevgan ertak qahramonini applika-tsiya usulida tayyorlashga harakat qiling.



Mustaqil ish namunalari.

Qog'ozdan tipratikan shaklini mustaqil yasab ko'ring.

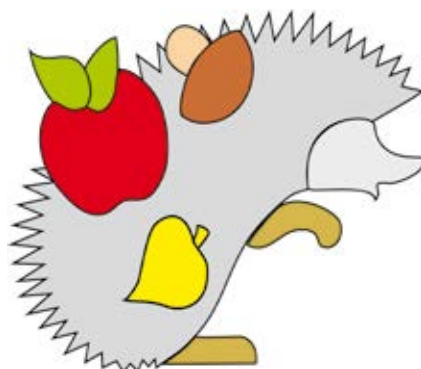
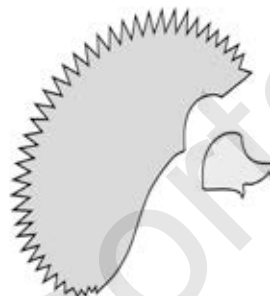

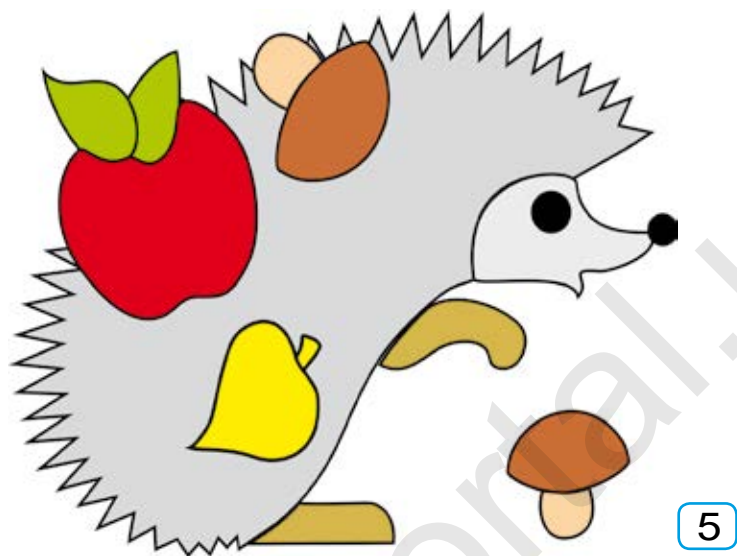

❓ Parranda shakli qanday geometrik shakllardan tashkil topgan?



PAPE-MASHE USULIDA PIYOLA TAYYORLASH VA BEZASH

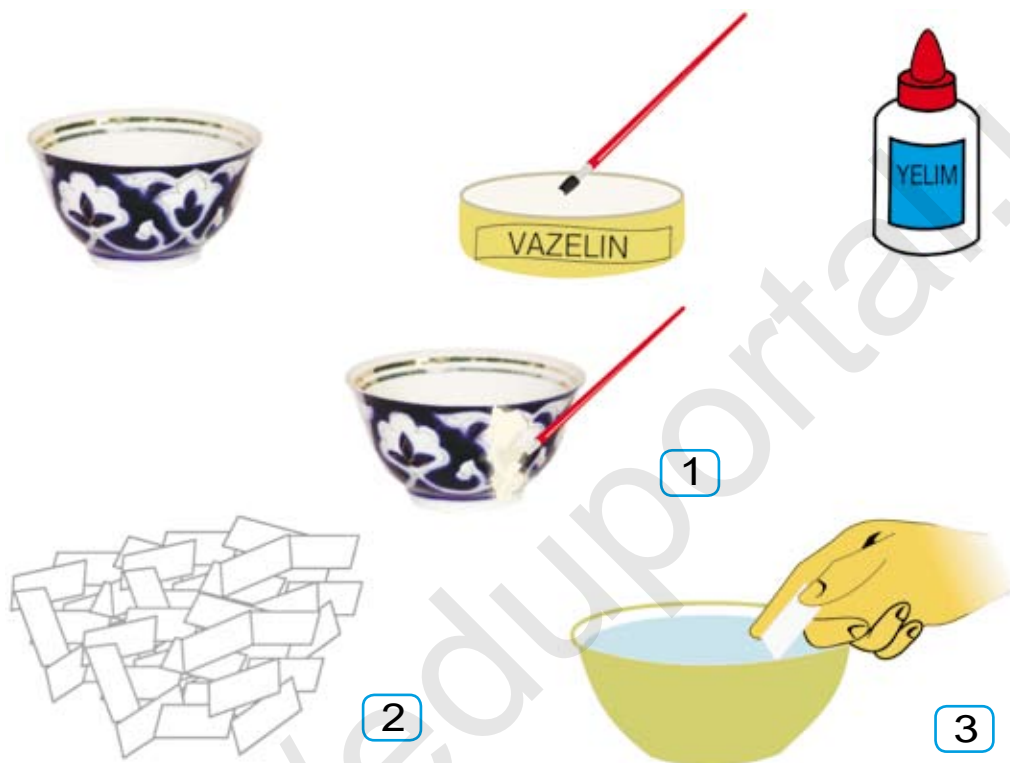

Piyola sirtiga vazelin yoki moy surting. Qog'ozni mayda bo'laklarga bo'ling. Piyolaning birinchi qavatiga qog'oz bo'laklarini suvga botirib, piyola yuzasiga tekis qilib yopishtiring. Ikkinchi qavatiga qog'oz bo'laklarini yelim yordamida yopishtirib chiqing.



Piyola tayyorlash uchun kerakli ish quollaridan to'g'ri foydalaning.



4



5



6



7



Qog'oz bo'laklarini ikkinchi qavatga uzunasiga yelimlang. Bu esa qog'oz qavatlarini yanglishib ketishdan saqlaydi. Bu holatni 6–7 marta takrorlang.



8



9

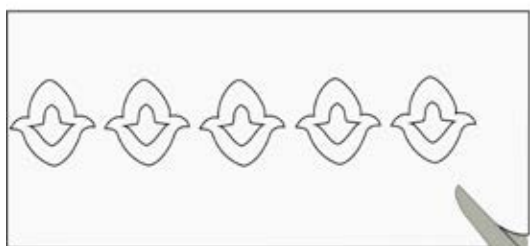

10



11



12



13



Piyolani 3 kun davomida quritishga qo'ying. So'ngra piyola sirtini ko'k rangga bo'yang va naqsh elementlari bilan bezang.

SOVG'A UCHUN SUVENIR YASASH



1



2



Yumshoq simga gul shaklini hosil qiluvchi gul yaproqlari uchun ikki xil rangli nozmunchoqlarni (biser) ketma-ketlikda joylashtiring.



3



4



Tayyorlangan gulga yana qanday qo'shimcha kiritish mumkin. Bu ishga ijodiy yondashing.



Bir nechta gul barglarini bir-biriga biriktirib, gul shaklini hosil qiling.



5



6



Mustaqil ish namunalari.





Mustaqil ish namunalari.



Ish namunalari kuzating. Mustaqil yasash jarayoniga o'zgartirish kiritishga harakat qiling.

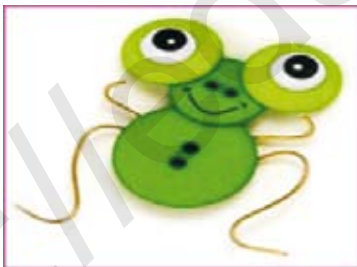

TURLI QOG‘OZLARDAN GIRLYANDLAR VA QOR PARCHASINI YASASH

! Qor parchasini quyidagi tartibda yasab ko‘ring.



1



2



3



4

? O‘ylab ko‘ring, yana qanday qor parchalarini yasash mumkin?

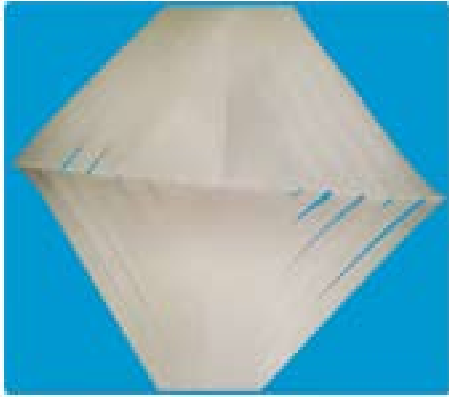

5

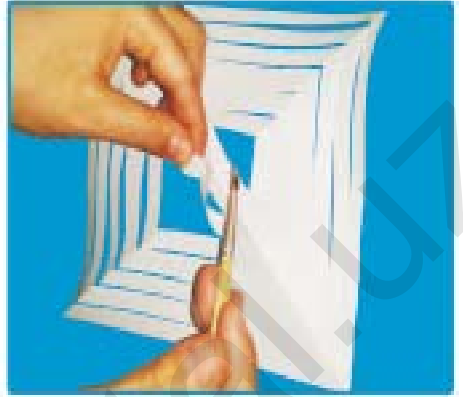

6



7



8



9



10



Mustaqil ish namunalari.



1



2



3



4

RANGLI QOG‘OZDAN ARCHA YASASH



1



2



3



4



Xavfsizlik qoidalariga rioya qiling.



5



6



Qog'oz qismlarini tartib bilan yelimlang.



7



8



9



10



11



12



13



Archaga mos o'yinchoqlar yasang.

2-nazorat ishi

Rangli qog'ozlardan hajmdor archa o'yinchog'ini tayyorlash

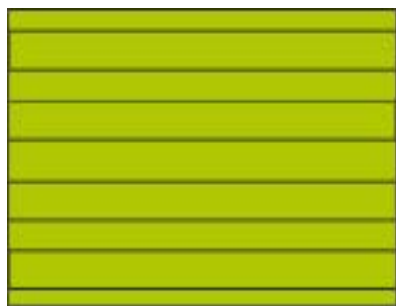

3



4



5



6

QISH MANZARASINI APPLIKATSIYA USULIDA YASASH



1



2

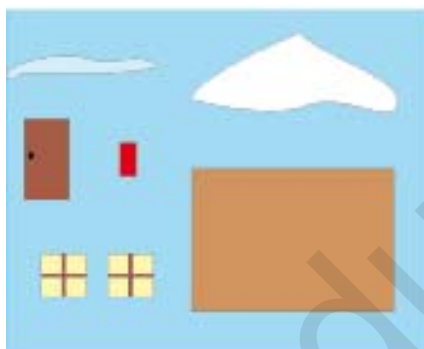

3



4



5



6



Har bir shaklni to'g'ri joylashtirib, qish manzarasini yarating.



7



8



Qish manzarasidan namunalar yasab ko'ring.
«O'zbekistonda qish» mavzusini mustaqil
applikatsiya usulida ishlashga harakat qiling.



TO'G'RI CHOK TIKISH



To'g'ri chok tikish uchun quyidagi qoidalarga amal qiling.

Igna bilan ishlash qoidalari:

1. Ignani ishlatib bo'lgach, maxsus igna yostiqchaga sanchib qo'ying.
2. Ignani hech qachon og'zingizga solmang.
3. Ish tikishdan oldin va keyin ignalar sonini tekshiring, yetishmagan ignalarni albatta toping va maxsus idishga solib qo'ying.

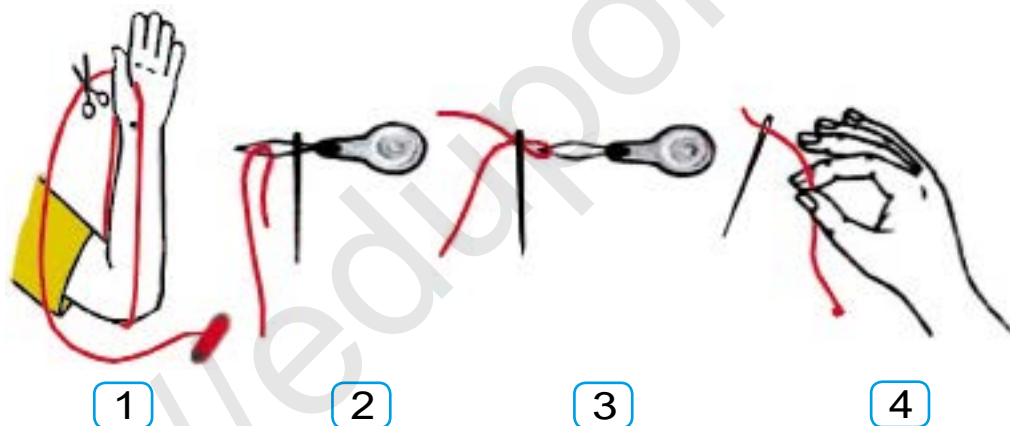

4. Kerakli uzunlikdagi ipni o'lchab, uni qirqib oling (1-rasm).
5. Ignaga ip o'tkazib, tugun hosil qilishni unut-mang (2,3,4-rasmlar).

Chok turlari bilan tanishing.

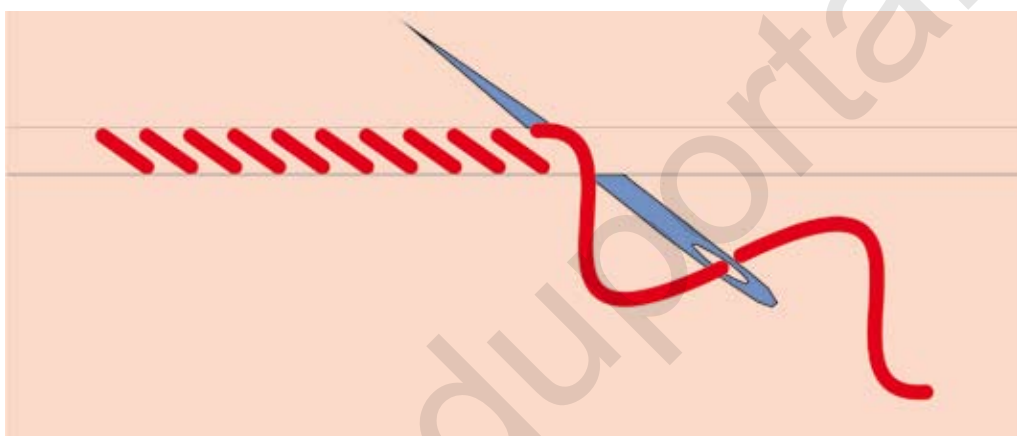
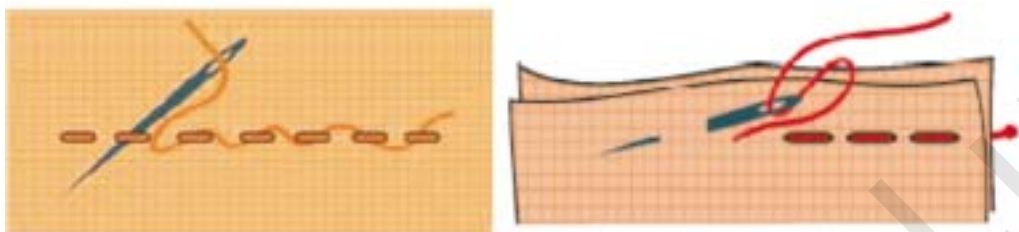

Turli choklarda tikishni o'rganing.

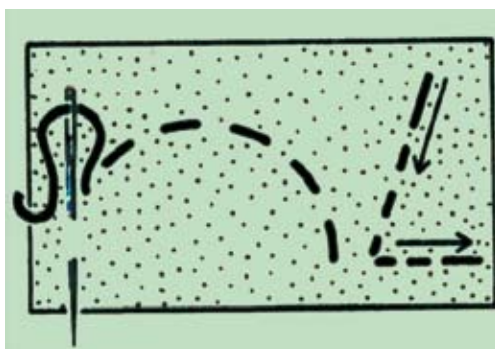
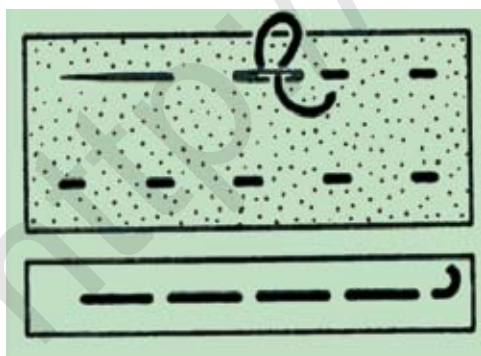



Mustaqil ish namunalari.



1



2



Kartondan tayyorlangan andaza asosida gazlama bo'laklaridan ixtiyoriy o'lchamdagi (doira) shaklni qirqib oling.



3



4



Qirqimlarga to'g'ri chok bilan ishlov bering.



5



6



7



Bezak choklaridan foydalaning.



Mustaqil ish namunalari.

To'g'ri chok yordamida chovgum ushlagich tiking.

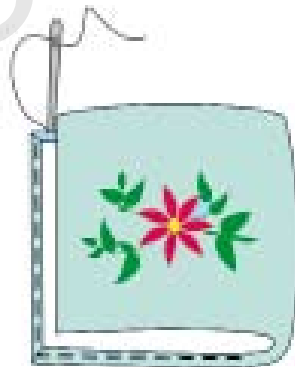
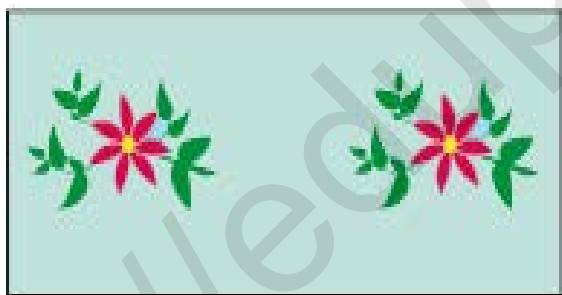

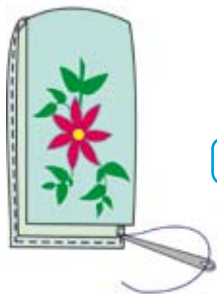

6

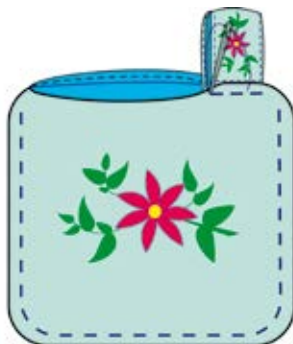

7



8

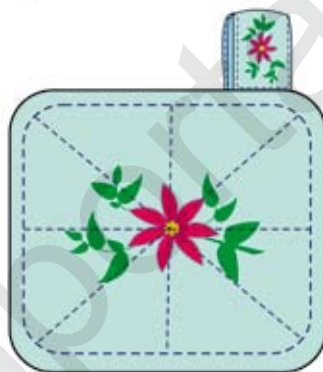

9



Qanday ushlagichdan foydalanish qulay?



10



Chovgum ushlagich shakliga o'zgartirish kiritish mumkin. Ularni tayyorlab ko'ring.

IGNA UCHUN YOSTIQCHA TIKISH

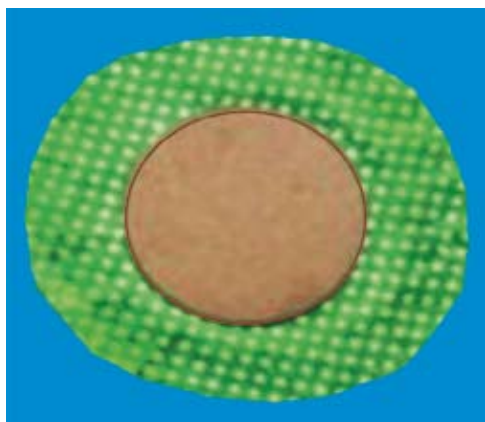

1



2



! Igna uchun yostiqcha tikish tartibi bilan tanishing. Amaliy ishga ijodiy yondashib, o'z (igna uchun yostiqcha) mahsulotingizni tayyorlang.



3



4

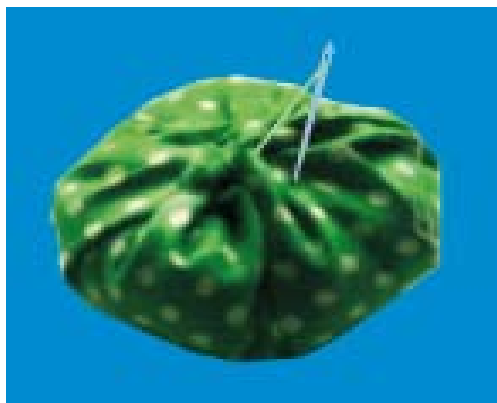

5



6



Igna bilan ishlashda xavfsizlik qoidasiga amal qilishni unutmang.



7



8

TURLI GEOMETRIK SHAKLLARDAN HARAKATLANUVCHI MODELLAR QURISH-YASASH



Kichik hajmdagi bo'sh qutichalardan harakatlanuvchi mashina modelini yasab ko'ring.

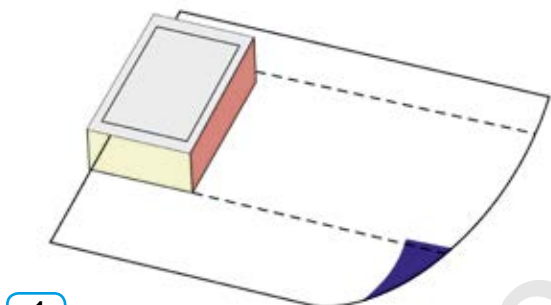

1

2

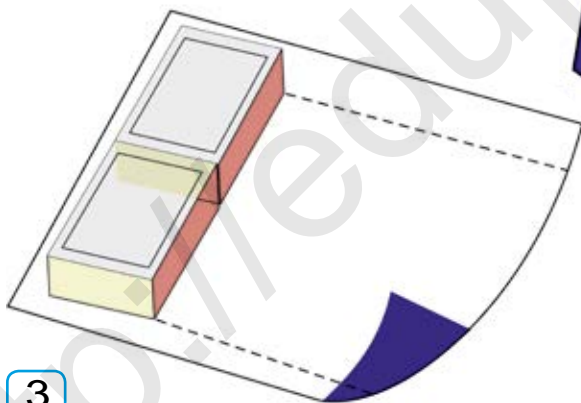
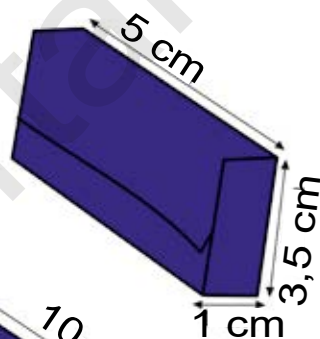

3

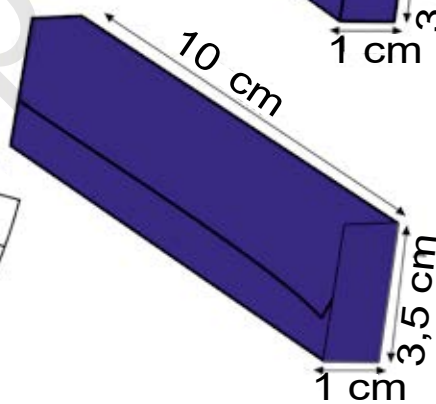

4



Harakatlanuvchi mashina model qismlarini to'g'ri belgilab oling.



Mashina g'ildiraklarini yasashda plastmassa qopqoqdan foydalaning.



5



6



7



Haydovchi erta tongdan kun botgunga qadar odamlarni o'z manzillariga bexatar yetib olishlari uchun xizmat qiladi.

Haydovchilik kasbi doim ziyraklik, hushyorlikni talab etadi.

BAHORGI GULLAR KOMPOZITSIYASINI TAYYORLASH



1

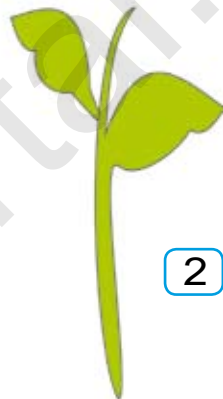

2



Bahor gullarini rangli qog'ozlardan yasab ko'ring!

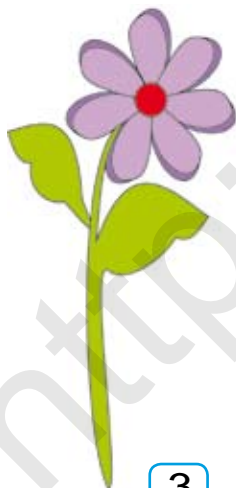

3



4



5

QOG‘OZNI BUKLASH VA QIRQISH USULIDA GULLAR SHAKLINI YASASH



Turli qog‘ozlardan bahorgi gullar kompozitsiyasini tayyorlash bosqichlarini ketma-ketlikda bajaring.





Mustaqil ish namunalari.

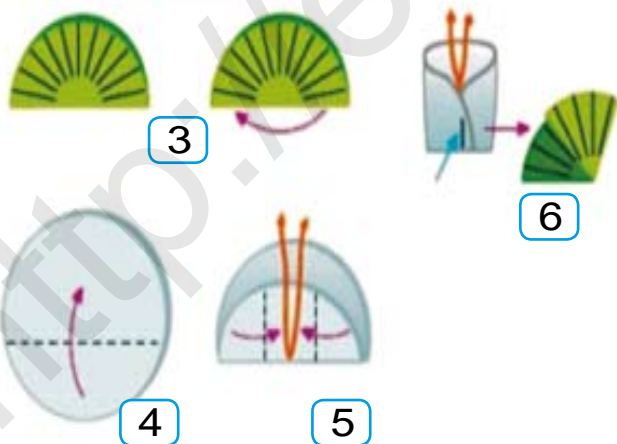
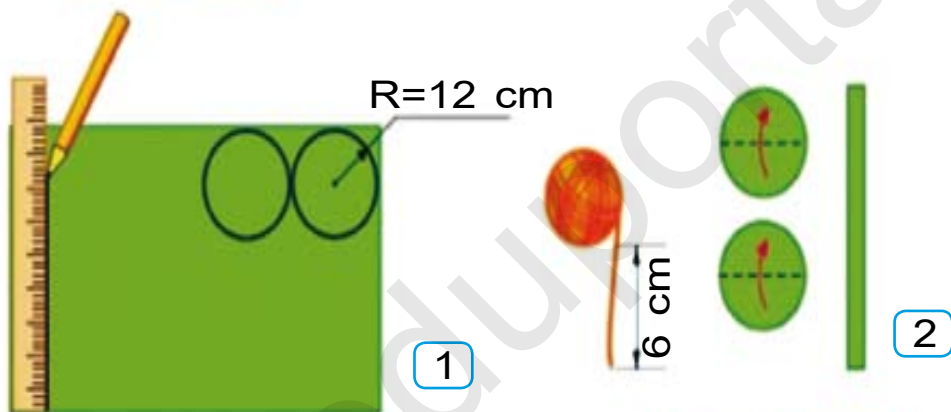

7

BAYRAMGA TABRIKNOMA YASASH



Kerakli ish quollarini tayyorlab oling.

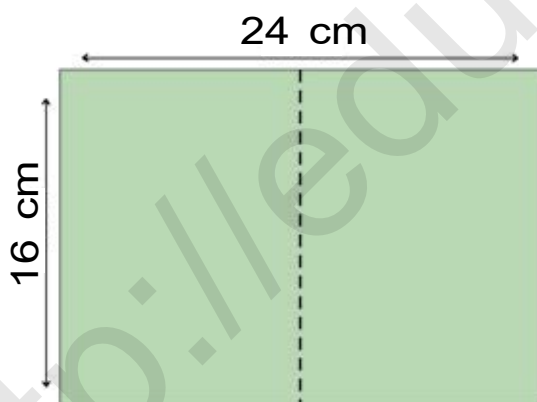
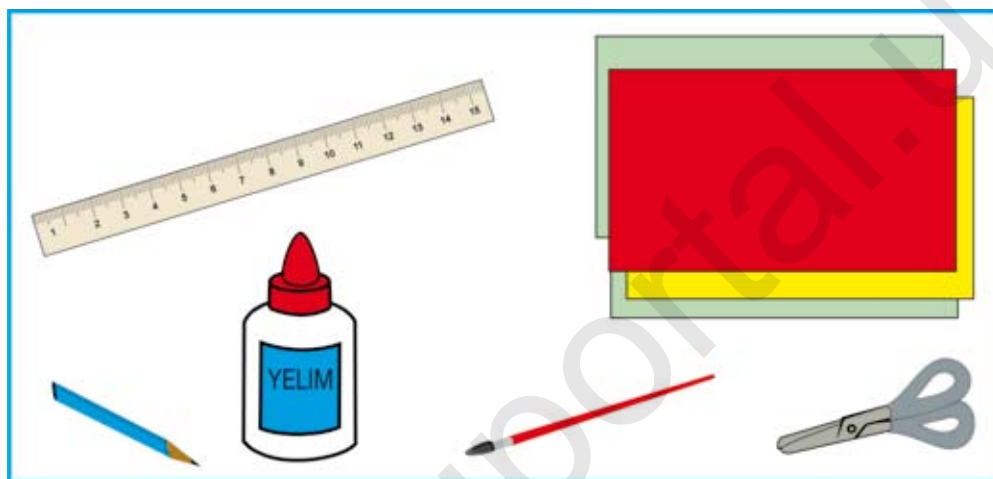

1

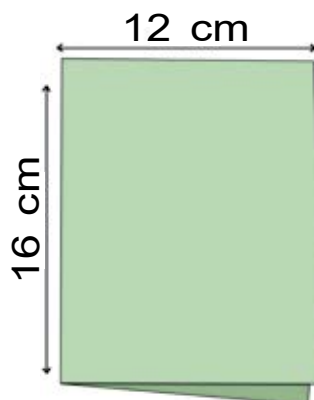

2



Tabriknoma yasash uchun o'lchamlarni to'g'ri belgilab oling.



O'lchami va rangini to'g'ri tanlang.

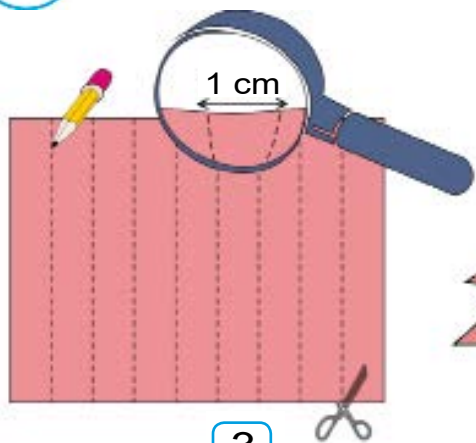

3

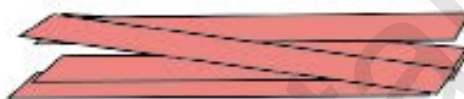

4



5



6

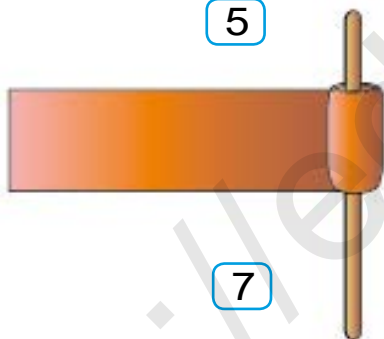

7

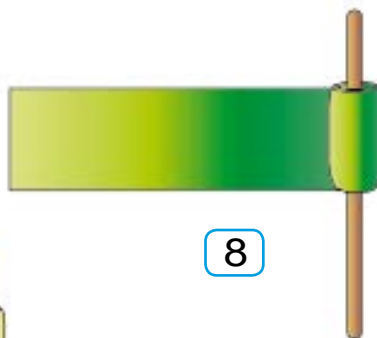

8

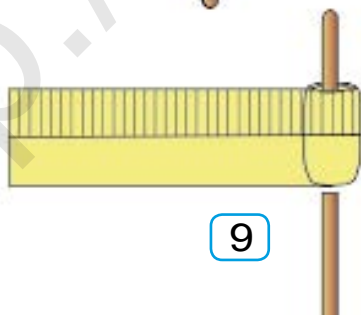

9



10



11



12



13



14



15



Kviling usulida gullar tayyorlashda maxsus qirqilgan qog'ozdan foydalaning.



16



17



18



19



20



Oyijonim, qutlug' bo'lsin,
Go'zal bahor bayramingiz.
Quchog'ingiz gulga to'lsin,
Shodliklarga har damingiz.

Ollobergan Po'lat



3-nazorat ishi

Applikatsiya usulida guldasta kompozitsiyasini yasash



1



2



3



4



Mustaqil yasab ko'ring.

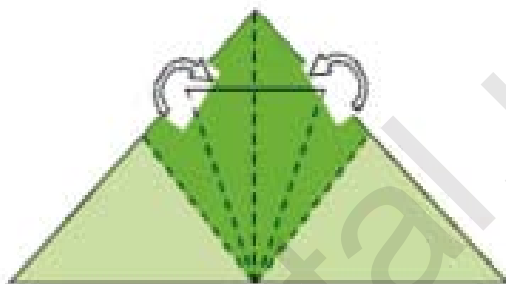
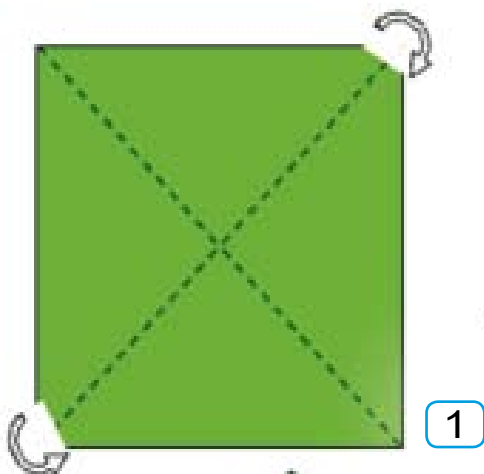

2

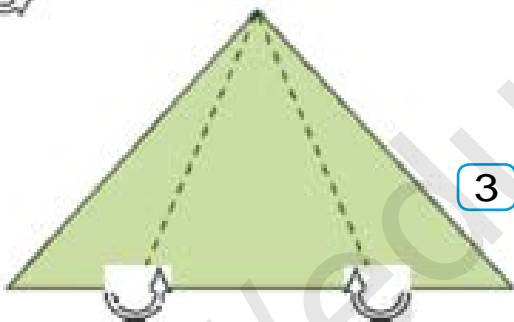

3



4

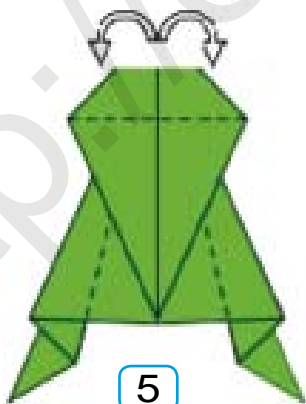

5

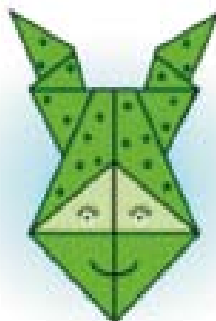

6

NAVRO'Z BAYRAMI UCHUN BEZAKLAR TAYYORLASH





Mustaqil ish namunalari.



1



2

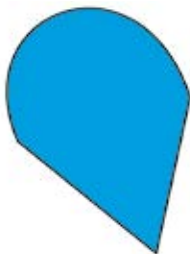

3



4



Turli qog'ozlardan bayram uchun qanday bezaklar tayyorlash mumkin?

«GULDONDA GULLAR» KOMPOZITSIYASINI YASASH

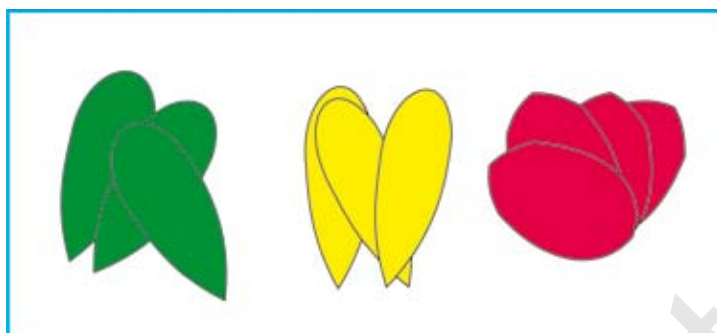

1

2



3

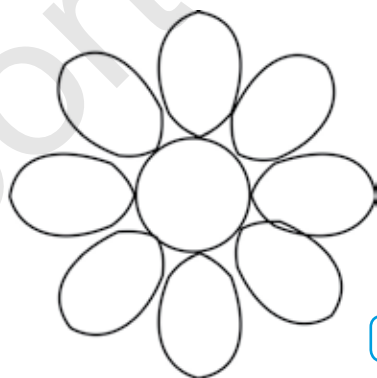

4



Urug'larni tartib bilan joylashtiring.



5



6





Turli materiallardan gullar shaklini yasab, o'zingizni qanchalik ijodkor ekanligingizni sinab ko'ring!





Mustaqil bajariladigan ishlar.

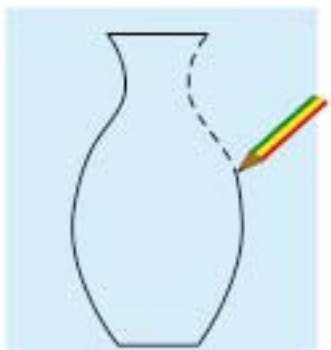

1



2



Guldon uchun andaza tayyorlang va uni gulli yoki rangli kartonga joylashtirib qirqib oling.



3



Guldon bo'laklarini biriktirib tikishda chok turlaridan foydalaning.



4



5



6

SUZUVCHI MODELLAR MAKETINI QURISH-YASASH

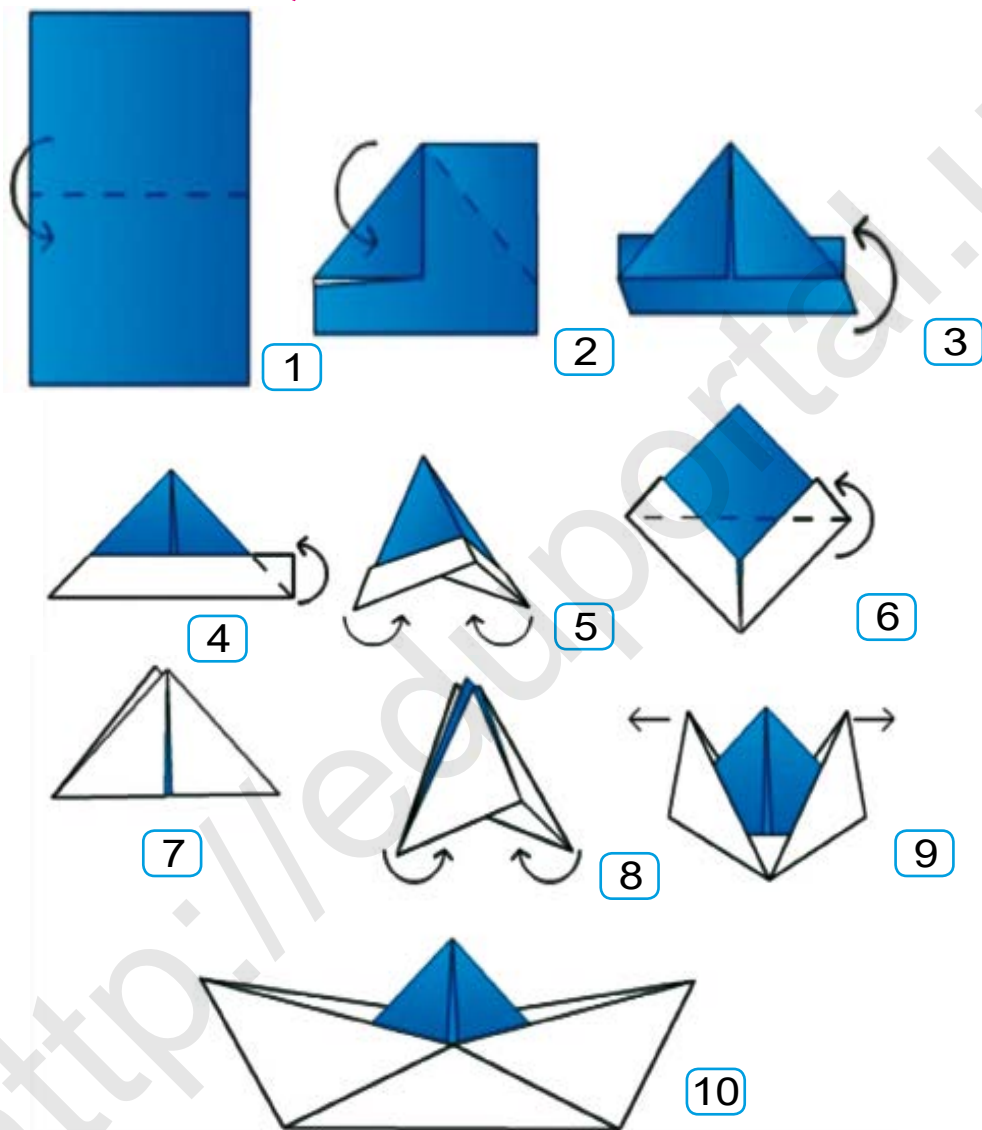

Suzuvchi modellarni yasashda qo‘shimcha manbalardan foydalaning.

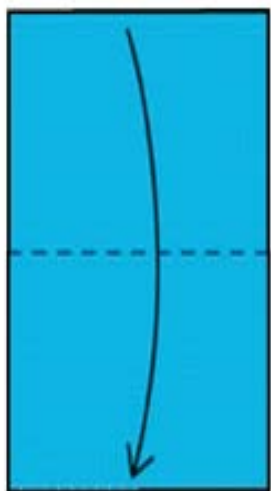

1

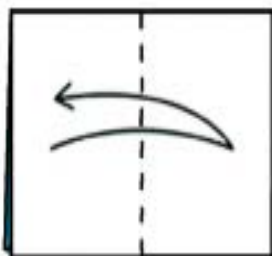

2

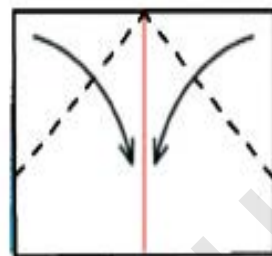

3

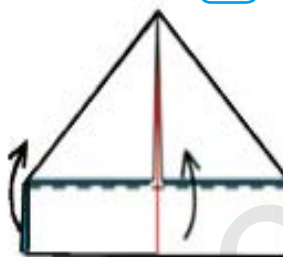

4

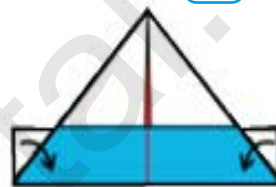

5



6

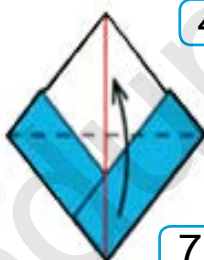

7



8



9



10

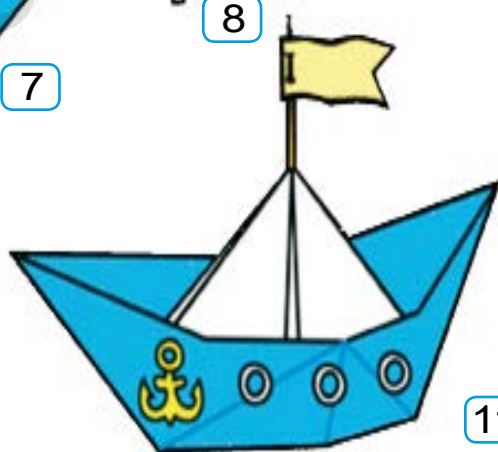

11



Tayyor qayiqchanning suvda suzishini albatta kuzatib ko'ring.

POROLON VA IPDAN YUMSHOQ O'YINCHOQLAR TAYYORLASH



Porolon bo'lagidan to'g'ri to'rtburchak shaklini tayyorlang. Unga baliq shakli qismlarini chizing va qirqib oling.

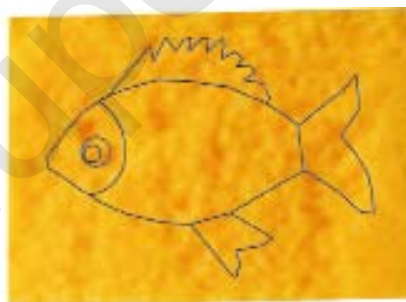

1

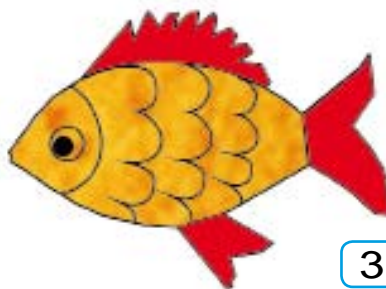
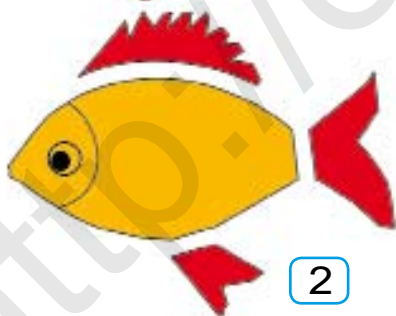

Baliqning qismlarini ketma-ketlikda joylashtirib chiqing.



Mustaqil bajariladigan ishlar.



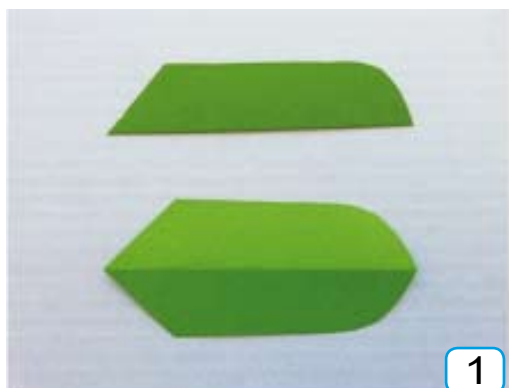

Mustaqil ravishda boshqa jonivorlarni ham yasab ko'ring.



IPDAN O'YINCHOQLAR YASASH



! Ipdan turli o'yinchoqlarni yasab ko'ring.



QOG‘OZNI QIRQISH VA BUKLASH USULIDA GULLAR SHAKLINI YASASH



Hajmdor gul shaklini yasashni bosqichma-bosqich bajaring.

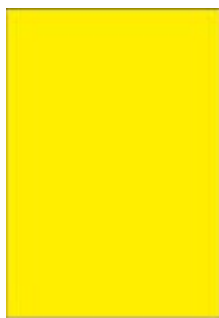

1

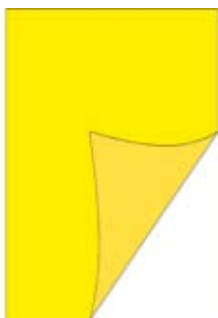

2



3

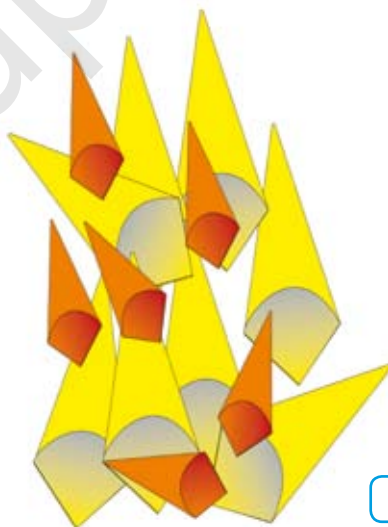

4



Qaychidan to‘g‘ri foydalanish qoidalariga rioya qiling.



Ishni ketma-ketlikda bajaring.

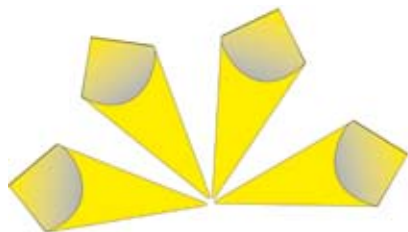

5

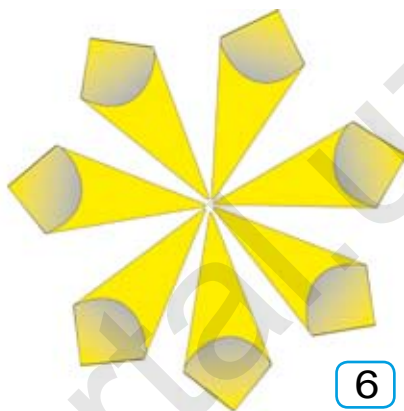

6

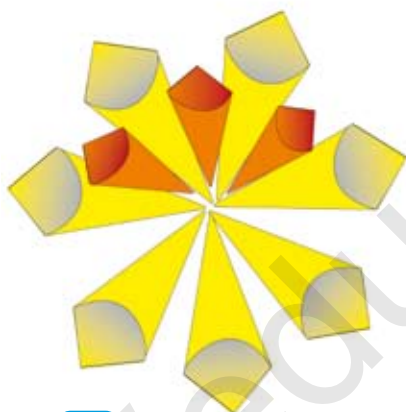

7

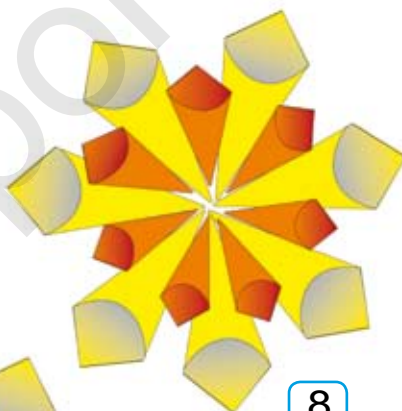

8

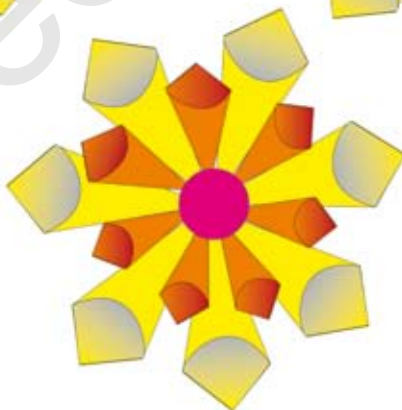

9

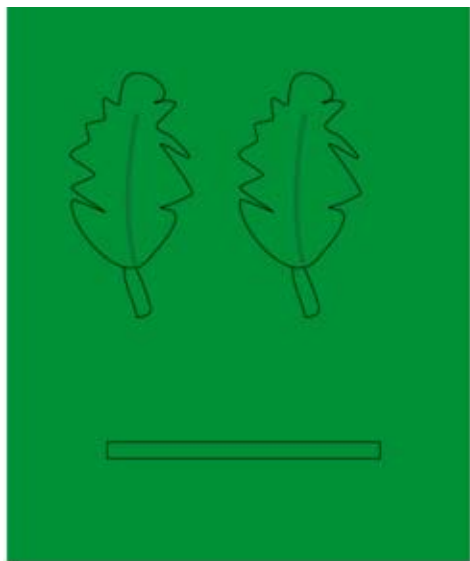

10



11



12



13



Gul yetishtiruvchi kasb egalari haqida ma'lumot to'plang va sinfdoshlaringiz bilan muhokama qiling.



Mustaqil ish namunalari.

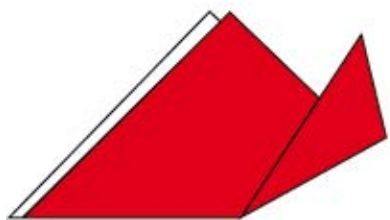

1



2

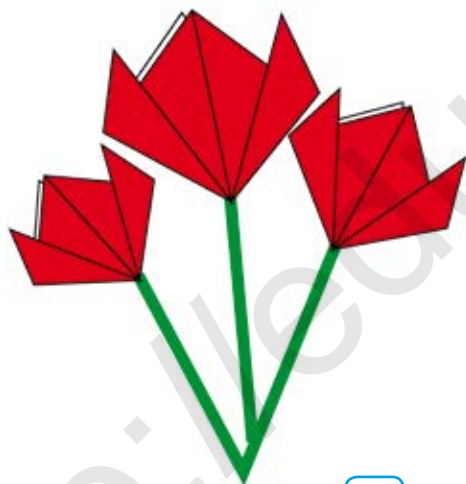

3

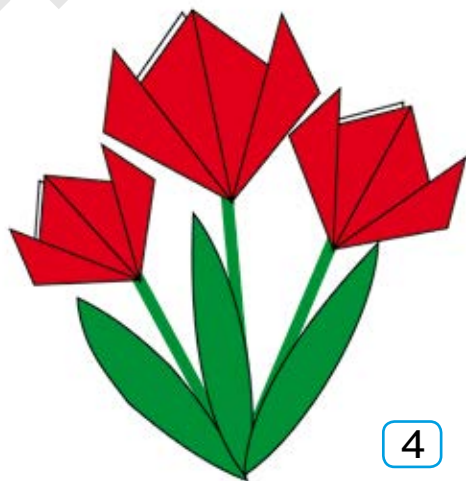

4



Lola gulini turli materiallardan mustaqil yasab ko'ring.

4-nazorat ishi

Turli qog'ozlardan kompozitsiya yasash



YOZ APPLIKATSIYASINI YASASH



Qog'ozdan «Yoz» mavzusini applikasiya usulida tayyorlang.

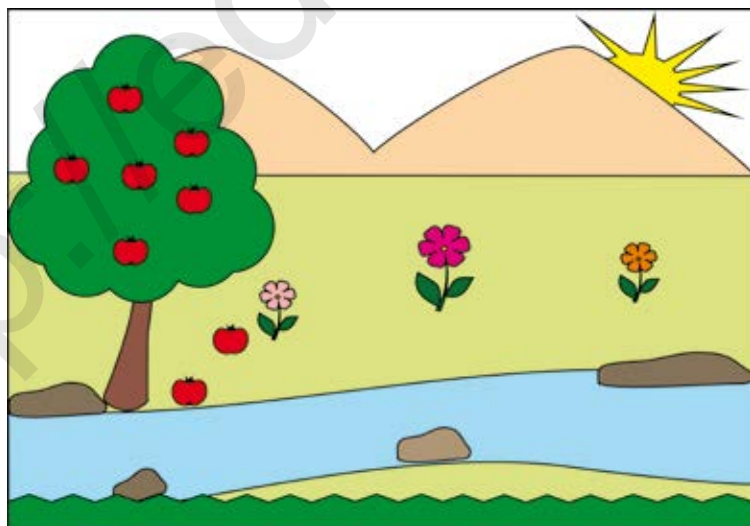
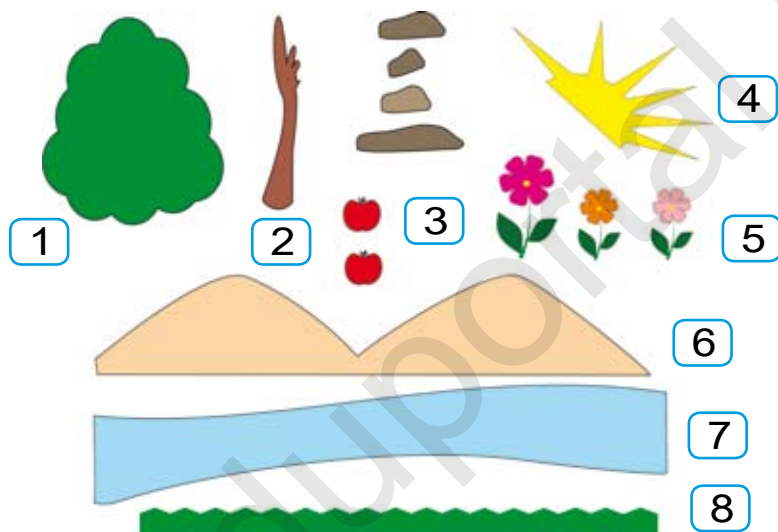

9



Mustaqil ish namunalari.





Mustaqil ish namunalari.



MUNDARIJA

Kirish	3
Texnologiya darsida bajariladigan ish namunalari	4
«Kuz» manzarasini applikatsiya usulida yasash	5
Kapalak shaklini qurish-yasash	7
Harakatli o'yinchoqlar yasash	10
Somondan applikatsiya usulida hayvonlar, gullar, jonivorlar shaklini yasash	14
«Ertak qahramonlari»ni applikatsiya usulida yasash	17
Pape-mashe usulida piyola tayyorlash va bezash	21
Sovg'a uchun suvenir yasash	24
Turli qog'ozlardan girlyandlar va qor parchasini yasash	27
Rangli qog'ozdan archa yasash	30
Qish manzarasini applikatsiya usulida yasash	34
To'g'ri chok tikish	36
Igna uchun yostiqcha tikish	42
Turli geometrik shakllardan harakatlanuvchi modellar qurish-yasash	44
Bahorgi gullar kompozitsiyasini tayyorlash	47
Qog'ozni buklash va qirqish usulida gullar shaklini yasash	48
Bayramga tabriknoma yasash	50
Navro'z bayrami uchun bezaklar tayyorlash	56
«Guldonda gullar» kompozitsiyasini yasash	58
Suzuvchi modellar maketini qurish-yasash	63

Porolon va ipdan yumshoq o‘yinchoqlar tayyorlash	65
Ipdan o‘yinchoqlar yasash	68
Qog‘ozni qirqish va buklash usulida gullar shaklini yasash	69
Yoz applikatsiyasini yasash	74

O'quv nashri

Xamrakul SANAKULOV,
Dilrabo XODIYEVA, Aziza SANAKULOVA

TEXNOLOGIYA

**Umumiy o'rta ta'lim maktablarining
3-sinfi uchun darslik**

*O'zbekiston Respublikasi Xalq ta'limi
vazirligi tasdiqlagan*

«Sharq» nashriyot-matbaa
aksiyadorlik kompaniyasi
Bosh tahririyati
Toshkent – 2019

Muharrir *Rasuljon Nafasov*
Badiiy muharrir *Tolib Qanoatov*
Texnik muharrir *Juldiz Kadirova*
Musahhah *Nigora Allaqulova*
Sahifalovchi *Mastura Atxamova*

Nashr litsenziyasi AI № 201, 28.08.2011-y.

Bosishga ruxsat etildi 18.02.2019. Bichimi 70x90 $\frac{1}{16}$,
«Arial» garniturasida. Kegli 14 shponli. Ofset bosma.
Shartli bosma tabog'i 5,85. Nashriyot-hisob tabog'i 2,61.
Adadi 493397 nusxa. Buyurtma № 444.

**«Sharq» nashriyot-matbaa aksiyadorlik kompaniyasi
bosmaxonasi, 100000, Toshkent shahri,
«Buyuk Turon» ko'chasi, 41.**

Ijaraga berilgan darslik holatini ko'rsatuvchi jadval

T/r	O'quvchining ismi, familiyasi	O'quv yili	Darslikning olingandagi holati	Sinf rahbarining imzosi	Darslikning topshirilgandagi holati	Sinf rahbarining imzosi
1						
2						
3						
4						
5						
6						

Darslik ijaraga berilganda va o'quv yili yakunida qaytarib olinganda yuqoridagi jadval sinf rahbari tomonidan quyidagi baholash mezonlariga asosan to'ldiriladi:

Yangi	Darslikning foydalanishga birinchi marotaba berilgandagi holati.
Yaxshi	Muqova butun, darslikning asosiy qismidan ajralmagan. Barcha varaqlari mavjud, yirtilmagan, ko'chmagan, betlarida yozuv va chiziqlar yo'q.
Qoniqarli	Muqova ezilgan, birmuncha chizilib, chetlari yedirilgan, darslikning asosiy qismidan ajralish holati bor, foydalanuvchi tomonidan qoniqarli ta'mirlangan. Ko'chgan varaqlari qayta ta'mirlangan, ayrim betlariga chizilgan.
Qoniqarsiz	Muqova chizilgan, yirtilgan, asosiy qismidan ajralgan yoki butunlay yo'q, qoniqarsiz ta'mirlangan. Betlari yirtilgan, varaqlari yetishmaydi, chizib, bo'yab tashlangan, darslikni tiklab bo'lmaydi.